

# TECHNICAL MANUAL

## UNIT AND DIRECT SUPPORT MAINTENANCE MANUAL (INCLUDING REPAIR PARTS AND SPECIAL TOOLS LIST) FOR

### MC-4 RAM AIR FREE-FALL PERSONNEL PARACHUTE SYSTEM

NSN 1670-01-306-2100

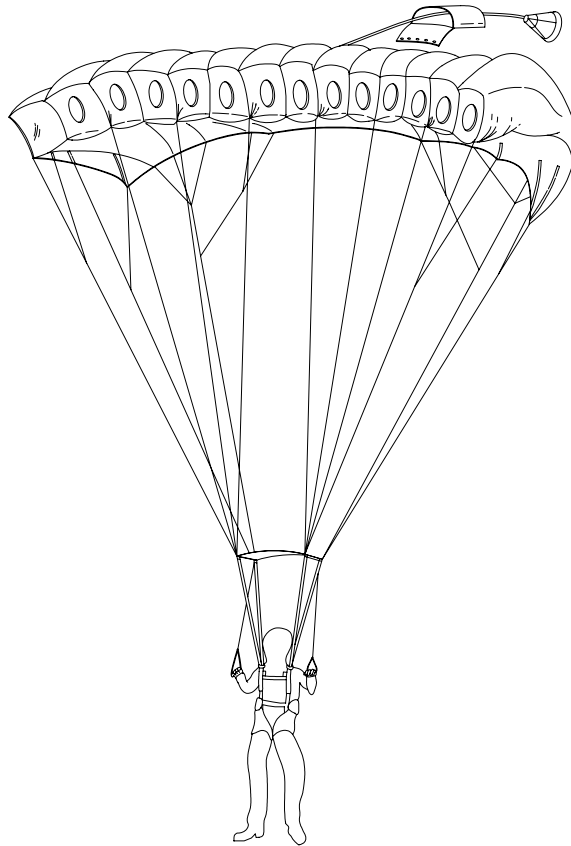

**DISTRIBUTION STATEMENT A:** Approved for public release; distribution is unlimited.  
\*This manual supercedes TM 10-1670-287-23&P, dated 31 January 1992



**WARNING SUMMARY**

**This warning summary contains general safety warnings and hazardous material warnings that must be understood and applied during operation and maintenance of this equipment. Failure to observe these precautions could result in serious injury or death to personnel.**

---

**WARNING**

---

Exercise extreme care when using petroleum products to destroy equipment by fire, as these materials are highly flammable. Improper handling may cause injury to personnel.

---

**WARNING**

---

Do not allow the release assembly to become wet in cold weather. It may freeze, stiffen the webbing, and fail in use causing death or serious injury.

---

**WARNING**

---

Any amount of extension past the index surface may mean the ripcord pins will not be pulled, which may result in death of parachutist.

---

**WARNING**

---

Failure to detect areas of damage during packing, or failure to comply with the following procedures, may result in a malfunction of the parachute and injury or loss of life to personnel.

---

**WARNING**

---

The reserve parachute-closing loop will be replaced at each reserve parachute repack cycle (120-days). Failure to comply may result in a malfunction of the parachute and injury, or loss of life, to personnel.

---

**WARNING**

---

The Stroke Simulator must be able to pull both reserve ripcord pins positively and completely to ensure adequate travel of the AR2 power cable. Inadequate travel of the AR2 power cable may cause the parachute to not deploy, resulting in serious injury or death of the parachutist.

---

**WARNING**

---

When attaching the power cable assembly to the AR2, always verify proper engagement of ball end of power cable with piston rod of AR2 by looking through transparent plastic cable seal retainer. Cable seal retainer and power cable seal must be present to ensure correct seating of power cable ball. If ball is not engaged with piston rod or if cable seal retainer is missing, actuation of AR2 will fail to pull ripcord pins, which may result in death of parachutist.

---

**WARNING**

---

The FF-2 must be able to pull the main ripcord pin positively and completely to ensure adequate travel of the FF-2 power cable. Inadequate travel of the FF-2 power cable may cause the parachute to not deploy, resulting in serious injury or death of the parachutist.



TM 10-1670-287-23&P

CHANGE  
NO. 2

HEADQUARTERS, DEPARTMENT OF THE ARMY  
WASHINGTON, DC, 31 AUGUST 2005

TECHNICAL MANUAL

UNIT AND DIRECT SUPPORT MAINTENANCE MANUAL  
(INCLUDING REPAIR PARTS AND SPECIAL TOOLS LIST)  
FOR

MC-4 RAM AIR FREE-FALL PERSONNEL PARACHUTE SYSTEM

NSN: 1670-01-306-2100

DISTRIBUTION STATEMENT A: - Approved for public release; distribution is unlimited.

TM 10-1670-287-23&P, 30 July 2003, is updated as follows:

1. File this sheet in front of the manual for reference.
2. This change implements Army Maintenance Transformation and changes the Maintenance Allocation Chart (MAC) to support Field and Sustainment Maintenance.
3. New or updated change information is indicated by a vertical bar in the outer margin of the page.
4. Remove old pages and insert new pages as indicated below:

**Remove Pages**  
A/(B Blank)

**Insert Pages**  
A/(B Blank)

5. Replace the following work packages with their revised version:

<b><u>Work Package Number</u></b>	<b><u>Work Package Number</u></b>	<b><u>Work Package Number</u></b>	<b><u>Work Package Number</u></b>
WP 0001 00	WP 0013 00	WP 0063 00	
WP 0004 00	WP 0014 00		
WP 0008 00	WP 0061 00		
WP 0011 00	WP 0062 00		

TM 10-1670-287-23&P  
C2

By Order of the Secretaries of the Army, Air Force, and Navy (Including the Marine Corps):

**PETER J. SCHOOMAKER**  
General, United States Army  
*Chief of Staff*

Official:

  
**SANDRA R. RILEY**  
*Administrative Assistant to the  
Secretary of the Army*  
0521620

**MICHAEL E. RYAN**  
*GENERAL, USAF*  
*Chief of Staff*

Official:

**GEORGE T. BABBETT**  
*General, USAF*  
*Commander, Air Force Materiel Command*

**D.G. MORRAL**  
*Rear Admiral, USN*  
*Program Executive Officer*  
*For Expeditionary Warfare*  
*Naval Sea Systems Command*

**R.P. SHOCKEY**  
*Director, Program Support*  
*Marine Corps Systems Command*

DISTRIBUTION:

To be distributed in accordance with initial distribution IDN 255304, requirements for TM10-1670-287-23&P.

TM 10-1670-287-23&P

CHANGE  
NO. 1

HEADQUARTERS, DEPARTMENT OF THE ARMY  
WASHINGTON, D.C., 31 JANUARY 2005

TECHNICAL MANUAL  
UNIT AND DIRECT SUPPORT MAINTENANCE MANUAL  
INCLUDING REPAIR PARTS AND SPECIAL TOOLS LIST  
FOR  
MC-4 RAM AIR FREE-FALL  
PERSONNEL PARACHUTE SYSTEM  
NSN 1670-01-306-2100

**DISTRIBUTION STATEMENT A** – Approved for public release; distribution is unlimited.

TM 10-1670-287-23&P, 30 July 2003, is updated as follows:

1. File this sheet in front of the manual for reference.
2. This change is a result of corrected National Stock Numbers (NSN)s and/or CAGEC codes and part numbers.
3. New or updated text is indicated by a vertical bar in the outer margin of the page.
4. Remove old pages and insert new pages as indicated below:

<u>Remove Pages</u>	<u>Insert Pages</u>	<u>Remove Pages</u>	<u>Insert Pages</u>
a/b	a/b	2028 Sample	2028 Sample
A/B	A/B	2028	2028
i-iv	i-iv	2028	2028

5. Replace the following work packages with their revised version:

<u>Work Package Number</u>	<u>Work Package Number</u>	<u>Work Package Number</u>	<u>Work Package Number</u>
0001 00	0008 00	0015 00	0048 00
0002 00	0010 00	0030 00	0070 00
0004 00	0011 00	0033 00	0071 00
0005 00	0013 00	0037 00	0074 00
0006 00	0014 00	0047 00	0076 00

6. Add the following new pages:

Insert Pages  
2028 Front/Back

ARMY TM 10-1670-287-23&P  
AIR FORCE T.O. 14D1-2-468-2  
MARINE CORPS TM 09011A-23&P  
NAVY NAVAIR 13-1-38

C-1

By Order of the Secretaries of the Army, Air Force, and Navy (to include Marine Corps):

PETER J. SCHOOMAKER  
General, United States Army  
*Chief of Staff*

Official:

  
SANDRA R. RILEY  
*Administrative Assistant to the  
Secretary of the Army*  
0436401

**MICHAEL E. RYAN**  
GENERAL, USAF  
*Chief of Staff*

Official:

GEORGE T. BABBETT  
**General, USAF**  
*Commander, Air Force Materiel Command*

D.G. MORRAL  
*Rear Admiral, USN  
Program Executive Officer  
For Expeditionary Warfare  
Naval Sea Systems Command*

R.P. SHOCKEY  
*Director, Program Support  
Marine Corps System Command*

DISTRIBUTION:

To be distributed in accordance with initial distribution number (IDN) 255304 requirements for TM 10-1670-287-23&P.

**INSERT LATEST UPDATED PAGES / WORK PACKAGES. DESTROY SUPERSEDED DATA.**

**LIST OF EFFECTIVE PAGES/WORK PACKAGES**

NOTE: The portion of text affected by the update is indicated by a vertical line in the outer margins of the page. Updates to illustrations are indicated by miniature pointing hands or vertical lines in the outer margins of the page in the area of the illustration changed. Zero in the "Change No." column indicates an original page or work package.

Dates of issue for original and changed pages / work packages are:

Original 30 July 2003  
 Change 1 31 January 2005  
 Change 2 31 August 2005

**TOTAL NUMBER OF PAGES FOR FRONT AND REAR MATTER IS 28. THE TOTAL NUMBER OF WORK PACKAGES IS 77, CONSISTING OF THE FOLLOWING:**

Page/WP No.	Change No.	Page/WP No.	Change No.
Front Cover	0	WP 0026 00 (4 pgs)	0
a - b	1	WP 0027 00 (4 pgs)	0
i-iv	1	WP 0028 00 (2 pgs)	0
v/(vi blank)	0	WP 0029 00 (2 pgs)	0
Chp 1 title page	0	WP 0030 00 (4 pgs)	1
WP 0001 00 (6 pgs)	2	WP 0031 00 (4 pgs)	0
WP 0002 00 (16 pgs)	1	WP 0032 00 (2 pgs)	0
WP 0003 00 (4 pgs)	0	WP 0033 00 (8 pgs)	1
Chp 2 title page	0	WP 0034 00 (2 pgs)	0
WP 0004 00 (8 pgs)	2	WP 0035 00 (2 pgs)	0
WP 0005 00 (20 pgs)	1	WP 0036 00 (2 pgs)	0
WP 0006 00 (26 pgs)	1	WP 0037 00 (12 pgs)	1
WP 0007 00 (2 pgs)	0	WP 0038 00 (2 pgs)	0
WP 0008 00 (4 pgs)	2	WP 0039 00 (4 pgs)	0
Chp 3 title page	0	WP 0040 00 (2 pgs)	0
WP 0009 00 (4 pgs)	0	WP 0041 00 (2 pgs)	0
WP 0010 00 (4 pgs)	1	WP 0042 00 (4 pgs)	0
WP 0011 00 (10 pgs)	2	WP 0043 00 (2 pgs)	0
WP 0012 00 (2 pgs)	0	WP 0044 00 (4 pgs)	0
WP 0013 00 (40 pgs)	2	WP 0045 00 (4 pgs)	0
WP 0014 00 (48 pgs)	2	WP 0046 00 (2 pgs)	0
WP 0015 00 (16 pgs)	1	WP 0047 00 (10 pgs)	1
WP 0016 00 (2 pgs)	0	WP 0048 00 (6 pgs)	1
WP 0017 00 (2 pgs)	0	WP 0049 00 (2 pgs)	0
WP 0018 00 (4 pgs)	0	Chp 4 title page	0
WP 0019 00 (2 pgs)	0	WP 0050 00 (12 pgs)	0
WP 0020 00 (2 pgs)	0	WP 0051 00 (2 pgs)	0
WP 0021 00 (2 pgs)	0	WP 0052 00 (2 pgs)	0
WP 0022 00 (2 pgs)	0	WP 0053 00 (2 pgs)	0
WP 0023 00 (2 pgs)	0	WP 0054 00 (4 pgs)	0
WP 0024 00 (2 pgs)	0	WP 0055 00 (4 pgs)	0
WP 0025 00 (4 pgs)	0	WP 0056 00 (2 pgs)	0

INSERT LATEST UPDATED PAGES / WORK PACKAGES. DESTROY SUPERSEDED DATA.

LIST OF EFFECTIVE PAGES/WORK PACKAGES - continued

Page/WP No.	Change No.
WP 0057 00 (2 pgs)	0
WP 0058 00 (4 pgs)	0
WP 0059 00 (4 pgs)	0
Chp 5 title page	0
WP 0060 00 (2 pgs)	0
WP 0061 00 (2 pgs)	2
WP 0062 00 (4 pgs)	2
WP 0063 00 (10 pgs)	2
WP 0064 00 (8 pgs)	0
WP 0065 00 (6 pgs)	0
WP 0066 00 (4 pgs)	0
WP 0067 00 (4 pgs)	0
WP 0068 00 (4 pgs)	0
WP 0069 00 (4 pgs)	0
WP 0070 00 (4 pgs)	1
WP 0071 00 (6 pgs)	1
WP 0072 00 (4 pgs)	0
WP 0073 00 (2 pgs)	0
WP 0074 00 (2 pgs)	1
WP 0075 00 (2 pgs)	0
WP 0076 00 (4 pgs)	1
WP 0077 00 (2 pgs)	0
Index-1 – Index –7/(8 Blank)	0
Back Cover	0

---

## TECHNICAL MANUAL

### UNIT AND DIRECT SUPPORT MAINTENANCE MANUAL (INCLUDING REPAIR PARTS AND SPECIAL TOOLS LIST) FOR

### MC-4 RAM AIR FREE-FALL PERSONNEL PARACHUTE SYSTEM NSN 1670-01-306-2100

#### REPORTING ERRORS AND RECOMMENDING IMPROVEMENTS

You can help improve this manual. If you find any mistakes or if you know of a way to improve the procedures, please let us know.

**ARMY** - Mail DA Form 2028 (Recommended Changes to Publications and Blank Forms), or DA Form 2028-2, located in the back of this manual, direct to: Commander, U.S. Army Tank-automotive & Armament Command, ATTN: AMSTA-LC-CECT, Kansas Street, Natick, MA 01760. You may also send in your recommended changes via electronic mail directly to [amssbriml@natick.army.mil](mailto:amssbriml@natick.army.mil). A reply will be furnished directly to you. Instructions for sending electronic 2028 may be found at the back of this manual immediately preceding the hard copy 2028.

**AIR FORCE** – Reports by U.S. Air Force units should be submitted on AFTO Form 22, Technical Order Publication Improvement Report and Reply, and forwarded to the address prescribed above for the Army. An informational copy of the prepared AFTO Form 22 shall be furnished to WP-ALC/TILTA, 420 2<sup>nd</sup> Street, Suite 100, Robins AFB, GA 31098-1640.

**MARINE CORPS** – Submit NAVMC Form 10772 to Commander, ATTN: (Code 850), Marine Corps Logistics Bases, 814 Radford Blvd., Albany, GA 31704-1128. A reply will be sent to you.

**NAVY** – Submit NAVSEA Form 4160/1 (REV 299) to Commander, NSDSA Code 5E30, NAVSURFSENDIV, 4363 Missile Way, Port Hueneme, CA 93043-4307. A reply will be sent to you.

---

**DISTRIBUTION STATEMENT A: Approved for public release; distribution is unlimited.**

\*This manual supersedes TM 10-1670-287-23&P, dated 31 January 1992

**TABLE OF CONTENTS**

	<b>WP Sequence No.</b>
<b>WARNING SUMMARY</b>	<b>a</b>
<b>HOW TO USE THIS MANUAL</b>	<b>V</b>
 <b>CHAPTER 1 - INTRODUCTION INFORMATION</b>	
General Information .....	0001 00
Equipment Description and Data .....	0002 00
Theory of Operation .....	0003 00
<hr/> <hr/>	
<b>CHAPTER 2 - OPERATOR MAINTENANCE INSTRUCTIONS</b>	
Service Upon Receipt .....	0004 00
Assembly – Reserve Parachute.....	0005 00
Assembly – Main Parachute .....	0006 00
Preventive Maintenance Checks and Services (PMCS), Introduction.....	0007 00
Preventive Maintenance Checks and Services (PMCS) .....	0008 00
<hr/> <hr/>	
<b>CHAPTER 3 - UNIT MAINTENANCE INSTRUCTIONS</b>	
Shakedown and Airing.....	0009 00
Cleaning and Drying .....	0010 00
Inspection.....	0011 00
Salt/Fresh-Water Contamination Test .....	0012 00
Packing Procedures – Reserve Parachute.....	0013 00
Packing Procedures – Main Parachute .....	0014 00
General Repair Procedures .....	0015 00
Searing and Waxing.....	0016 00
Marking and Restenciling.....	0017 00
Main Pilot Chute Bridle Line or Deployment Bag.....	0018 00
Main Pilot Chute.....	0019 00
Main and Reserve Pilot Chute Attachment.....	0020 00
Main Deployment Bag.....	0021 00
Reserve Pilot Chute or Reserve Deployment Bag and Bridle Line .....	0022 00
Safety Stow Loop.....	0023 00
General Canopy Repair (Main and Reserve) .....	0024 00
Main Canopy Replacement.....	0025 00
Reserve Canopy Replacement.....	0026 00
Crossport Main or Reserve Canopy.....	0027 00
Stabilizer Left or Right, Main or Reserve Canopy.....	0028 00
Tail Seam Main or Reserve Canopy .....	0029 00
Slider Main and Reserve Canopy .....	0030 00
Slider Stop Main and Reserve Canopy.....	0031 00
Connector Links Main and Reserve Canopy .....	0032 00
Main Risers .....	0033 00
Main Canopy Release Cable Channel.....	0034 00



**TABLE OF CONTENTS - Continued**

**WP Sequence No.**

**CHAPTER 3 - UNIT MAINTENANCE INSTRUCTIONS**

Riser Hook and Pile Tapes .....	0035 00
Suspension Line Attaching Loop .....	0036 00
Harness/Container .....	0037 00
Grommets .....	0038 00
Snap Fasteners.....	0039 00
Main Ripcord Pocket.....	0040 00
Reserve Ripcord Pocket .....	0041 00
Main Canopy Release Ripcord and Housing.....	0042 00
Reserve Ripcord Housing.....	0043 00
Main Ripcord Housing.....	0044 00
AAD Junction Plate .....	0045 00
AR2 Ripcord Release Pocket (Padded) .....	0046 00
AR2 Power Cable Assembly Installation/Mounting.....	0047 00
Porosity Procedures.....	0048 00
Conversion (Reserve Canopy to a Main Canopy).....	0049 00

**CHAPTER 4 - DIRECT SUPPORT MAINTENANCE INSTRUCTIONS**

General Repair Procedures .....	0050 00
Searing and Waxing.....	0051 00
Marking and Restenciling.....	0052 00
Suspension Lines (Lines 4 A/B and 5A/B Only) .....	0053 00
Suspension Line Sets (Preferred Method).....	0054 00
Suspension Lines/Cascade Lines (Alternate Method).....	0055 00
Suspension Line Attaching Loop .....	0056 00
Control Lines.....	0057 00
Canopy Rib .....	0058 00
Section Replacements .....	0059 00

**CHAPTER 5 - SUPPORTING INFORMATION**

Preparation for Storage.....	0060 00
Preparation for Shipment.....	0061 00
References.....	0062 00
Maintenance Allocation Chart (MAC) .....	0063 00
Repair Parts and Special Tools List (RPSTL), Introduction.....	0064 00
Group 00, MC-4 Ram Air Free Fall Personnel Parachute System.....	0065 00
Group 01, Main Deployment Bag.....	0066 00
Group 02, Reserve Deployment System .....	0067 00
Group 03, Main Canopy.....	0068 00
Group 04, Reserve Canopy .....	0069 00
Group 05, Main Risers .....	0070 00
Group 06, Harness/Container .....	0071 00
Group 99, Bulk Materials .....	0072 00
Special Tools List.....	0073 00
National Stock Number (NSN) Index .....	0074 00

**TABLE OF CONTENTS - Continued**

**WP Sequence No.**

**CHAPTER 5 - SUPPORTING INFORMATION - continued**

Part Number Index.....	0075 00
Expendable/Durable Supplies and Materials List .....	0076 00
Illustrated List of Manufactured Items .....	0077 00

---

---

<b>ALPHABETICAL INDEX.....</b>	<b>INDEX 1</b>
--------------------------------	----------------

## HOW TO USE THIS MANUAL

In this manual, primary chapters appear in upper case/capital letters; work packages are presented in numeric sequence, e.g., 0001 00; paragraphs within a work package are not numbered and are presented in a titles format. For a first level paragraph, title all upper case/capital letters, e.g., FRONT MATTER subordinate paragraph title will have the first letter of the first word of each principle word all upper case/capital letters, e.g., Manual Organization and Page Numbering System. The location of additional material that must be referenced is clearly marked. Illustrations supporting maintenance procedures/text are located underneath, or as close as possible to, their referenced paragraph.

**FRONT MATTER.** Front matter consists of front cover, warning summary, title block, table of contents, and how to use this manual page.

**CHAPTER 1 - INTRODUCTION.** Chapter 1 contains general information and equipment.

**CHAPTER 2 - OPERATOR INSTRUCTIONS.** Chapter 2 contains service upon receipt, initial receipt, receipt of used parachute assembly, and preventive maintenance checks and services (PMCS), lubrication instructions, and maintenance procedures authorized at operator level.

**CHAPTER 3 – UNIT MAINTENANCE INSTRUCTIONS.** Chapter 3 contains maintenance procedures authorized at the unit level.

**CHAPTER 4 – DIRECT SUPPORT MAINTENANCE INSTRUCTIONS.** Chapter 4 provides maintenance procedures authorized at the direct support level.

**CHAPTER 5 - SUPPORTING INFORMATION.** Chapter 5 contains references, expendable and durable items list, maintenance allocation chart, repair parts and special tools list, national stock number index, part number index, and illustrated list of manufactured items.

**REAR MATTER.** Rear matter consists of alphabetical index, DA Form 2028, authentication page, and back cover.

**Manual Organization and Page Numbering System.** The manual is divided into five major chapters that detail the topics mentioned above. Within each chapter are work packages covering a wide range of topics. Each work package is numbered sequentially starting at page 1. The work package has its own page-numbering scheme and is independent of the page numbering used by other work packages. Each page of a work package has a page number of the for XXXX YY-ZZ where XXXX is the work package number (e.g. 0010 is work package 10), YY is the revision number for that work package, and ZZ represents the number of the page within that work package. A page number such as 0010 00-1/(2 blank) means that page 1 contains information but page 2 of that work package has been intentionally left blank.

**Finding Information.** The table of contents permits the reader to find information in the manual quickly. The reader should start here first when looking for a specific topic. The table of contents lists the topics contained within each chapter and the work package sequence number where it can be found.

Example: If the reader were looking for instructions on “Conversion (Reserve Canopy to a Main Canopy)”, which is a unit maintenance topic, the table of contents indicates that unit maintenance information can be found in chapter 3. Scanning down the listings for chapter 3, Conversion (Reserve Canopy to a Main Canopy) information can be found in WP 0049 00 (Work Package 49).

An Alphabetical Index can be found at the back of the manual; specific topics are listed with the corresponding work package number.



## **CHAPTER 1**

### **INTRODUCTORY INFORMATION FOR MC-4 RAM AIR FREE-FALL PERSONNEL PARACHUTE SYSTEM**



---

**MC-4 RAM AIR FREE-FALL PERSONNEL PARACHUTE SYSTEM  
GENERAL INFORMATION**

---

**SCOPE**

This manual contains instructions for organizational and Direct Support (DS) maintenance on the MC-4 Ram Air Free-Fall Personnel Parachute System. Included are procedures for service upon receipt, packing procedures, maintenance procedures, and repair parts and special tool lists.

**MAINTENANCE FORMS, RECORDS, AND REPORTS**

Department of the Army forms and procedures used for equipment maintenance will be those prescribed by DA PAM 738-751, Functional Users Manual For The Army Maintenance Management System (TAMMS). Additional maintenance forms, records, and reports that are to be used by organizational and direct support maintenance personnel are listed in and prescribed by TM 10-1670-201-23 and TB 43-0002-43. TM 4700-15/1 prescribes maintenance forms and records used by the Marine Corps.

**REPORTING EQUIPMENT IMPROVEMENT RECOMMENDATIONS (EIR)**

**Army.** If the MC-4 needs improvement, let us know. Send us an EIR. You, the user, are the only one who can tell us what you don't like about your equipment. Let us know why you don't like the design. Tell us why a procedure is hard to perform. Put it on a SF 368 (Product Quality Deficiency Report). Mail it to us at Commander, U.S. Army Tank-automotive & Armament Command, 15 Kansas Street, Natick, MA 01760. A reply will be furnished directly to you.

**Air Force.** Reports by U.S. Air Force units should be submitted on AFTO Form 22, Technical Order Publication Improvement Report, and forwarded to the address prescribed above for the Army. An information copy of the prepared AFTO Form 22 shall be furnished to ALC/LDEAM, Kelly AFB, TX 78241.

**Navy.** Submit NAVSEA Form 4160/1 (REV 2-99) to Commander, NSDSA Code 5E30, NAVSURFCENDIV, 4363 Missile Way, Port Hueneme, CA 93043-4307. A reply will be sent to you.

**Marine Corps.** Submit NAVMC Form 10772 to Life Cycle Management Center, ATTN: Product Support Section 822, 814 Radford Blvd., Albany GA 31704-0320. A reply will be sent to you.

**CORROSION PREVENTION AND CONTROL (CPC)**

Corrosion Prevention and Control (CPC) of Army materiel is a continuing concern. It is important that any corrosion problems with this item be reported so that the problem can be corrected and improvements can be made to prevent the problem in future items.

While corrosion is typically associated with rusting of metals, it can also include deterioration of other materials, such as rubber and plastic. Unusual cracking, softening, swelling, or breaking of these materials may be a corrosion problem.

If a corrosion problem is identified, it can be reported using Standard Form SF 368, Product Quality Deficiency Report. Use of keywords such as "corrosion," "rust," "deterioration," or "cracking" will ensure that the information is identified as a CPC problem.

The form should be submitted to the address specified in DA PAM 750-8, The Army Maintenance Management System, Users Manual (TAMMS).

**OZONE DEPLETING SUBSTANCES (ODS)**

Not applicable.

## DESTRUCTION OF ARMY MATERIAL TO PREVENT ENEMY USE

### GENERAL INFORMATION:

**Objective.** Methods of destruction used to inflict damage on air delivery equipment should make it impossible to restore equipment to a usable condition in a combat zone by either repair or cannibalization.

**Authority.** Destruction of air delivery equipment that is in imminent danger of capture by an enemy is a command decision that must be made by a battalion or higher commander or the equivalent.

**Implementation plan.** All units that possess air delivery equipment should have a plan for the implementation of destruction procedures.

**Training.** All personnel who use or perform such functions as rigging, packing, maintenance, or storage of air delivery equipment should receive thorough training on air delivery equipment destruction procedures and methods. The destruction methods demonstrated during training should be simulated. Upon completion of training, all applicable personnel should be thoroughly familiar with air delivery equipment destruction methods and be capable of performing destruction without immediate reference to any publication.

### SPECIFIC METHODS:

Specific methods of destroying Army material to prevent enemy use shall be by mechanical means, fire, or by use of natural surroundings.

**Destruction by Mechanical Means.** Air delivery equipment metal assemblies, parts, and packing aids shall be destroyed using hammers, bolt cutters, files, hacksaws, drills, screwdrivers, crowbars, or other similar devices to smash, break, bend, or cut.

### WARNING

Exercise extreme care when using petroleum products to destroy equipment by fire, as these materials are highly flammable. Improper handling may cause injury to personnel.

**Destruction by Fire.** Items that can be destroyed by fire shall be burned. The destruction of equipment by use of fire is an effective method of destroying low melting point metal items. However, mechanical destruction should be completed first, whenever possible, before initiating destruction by fire. When items to be destroyed are made of metal, textile materials (or some comparable low combustible material) they should be packed under and around the item, then soaked with a flammable petroleum product and ignited. Proper concentration of equipment that is suitable for burning will provide a hotter and more destructive fire.

**Destruction by Use of Natural Surroundings.** Small vital parts of assemblies that are easily accessible may be disposed of as follows. Disposal or denial of equipment to an enemy may be accomplished through use of natural surroundings. Accessible vital parts of assemblies may be removed and scattered through dense foliage, buried in dirt or sand, or thrown into a lake, stream, or other body of water. Total submersion of equipment in a body of water will provide water damage as well as concealment. Salt water will inflict extensive damage to air delivery equipment.

**Other Methods of Destruction.** Oxygen system equipment will be destroyed as prescribed in TM 750-244-1-2.



**PREPARATION FOR STORAGE AND SHIPMENT**

For storage, refer to TM 10-1670-201-23/T.O. 13C-1-41/NAVAIR 13-1-17, and WP 0060 00 of this manual; for shipment, refer to WP 0061 00 of this manual.

**WARRANTY INFORMATION**

The MC-4 Ram Air Free-Fall Personnel Parachute System does not contain warranty provisions.

**LIST OF ACRONYMS AND ABBREVIATIONS**

<b>Common Name</b>	<b>Official Nomenclature</b>
MC-4	MC-4 Ram Air Free-Fall Personnel Parachute System

**LIST OF ACRONYMS AND ABBREVIATIONS**

AAD	Automatic Activation Device
AGL	Above Ground Level
AR2	Automatic Ripcord Release
BER	Beyond Economical Repair
BOI	Basis of Issue
CAGEC	Commercial and Government Entity Code
CFM	Cubic Feet Per Minute
Cm.	Centimeter
CPC	Corrosion Prevention and Control
DA	Department of the Army
DS	Direct Support
Dtd.	Dated
EA	Each
EIR	Equipment Improvement Recommendation
EDS	Electrostatic Discharge Sensitive
F	Fahrenheit
FF-2	Free Fall Secondary
fps	Feet Per Second
FSC	Federal Supply Classification

**LIST OF ACRONYMS AND ABBREVIATIONS – CONTINUED**

ft.	Feet
GPM	Ground Precautionary Message
in.	Inches
KIAS	Knots Indicated Air Speed
Ltrs	Liters
LG	Long
Lbs	Pounds
MAC	Maintenance Allocation Chart
MAM	Maintenance Advisory Message
MSL	Mean Sea Level
MTOE	Modified Table of Organization and Equipment
MTG	Mounting
MWO	Modification Work Order
NF	National Fine (Thread)
NIIN	National Item Identification Number
NLT	No Later Than
No.	Number
NSN	National Stock Number
OD	Olive Drab
oz.	Ounces
PMCS	Preventive Maintenance Checks and Services
PQDR	Product Quality Deficiency Report
psi	Pounds Per Square Inch
RAPPS	Ram Air Personnel Parachute System
RFI	Ready For Issue
RPSTL	Repair Parts and Special Tools List
SDR	Supply Discrepancy Report

---

**LIST OF ACRONYMS AND ABBREVIATIONS – CONTINUED**

SMR	Source, Maintenance and Recoverability
TAMMS	The Army Maintenance Management System
TB	Technical Bulletin
TMDE	Test Measurement and Diagnostic Equipment
UOC	Usable on Code
WP	Work Package

**SAFETY, CARE AND HANDLING**

The following subparagraphs summarize the safety, care and handling requirements for the MC-4 Ram Air Free-Fall Personnel Parachute System.

**Safety.** Use care in handling packed parachutes as exposed metal parts could cause painful injuries.

**Care and Handling.** Every effort shall be made to protect the parachute from weather elements, dust, dirt, oil, grease, and acid. An unpacked parachute shall be placed in an aviator kit bag. When available, an environmentally controlled building should be used to store parachutes. Parachutes shall be stored in a dry, well-ventilated location and protected from pilferage, dampness, fire, dirt, insects, rodents, and direct sunlight.

**COMMON TOOLS AND EQUIPMENT**

For authorized common tools and equipment, refer to the Modified Table of Organization and Equipment (MTOE) applicable to your unit.

**SPECIAL TOOLS, TEST MEASUREMENT AND DIAGNOSTIC EQUIPMENT (TMDE), AND SUPPORT EQUIPMENT**

Special tools, TMDE and support equipment are not required.

**REPAIR PARTS AND SPECIAL TOOLS LIST (RPSTL)**

Repair parts are listed and illustrated in WP 0065 00 through WP 0072 00 of this manual.

**END OF WORK PACKAGE**



---

**MC-4 RAM AIR FREE-FALL PERSONNEL PARACHUTE SYSTEM  
EQUIPMENT DESCRIPTION AND DATA**

---

**EQUIPMENT CHARACTERISTICS, CAPABILITIES, AND FEATURES**

A summary of the characteristics, capabilities and features of the equipment is contained in the following subparagraphs:

The MC-4 Ram Air Free-Fall Personnel Parachute System (front and back view) is designed to place Army personnel into areas of mission interest. An MC-4's inherent gliding capability offers important potential for minimizing detection during entry or changing the landing area during descent in order to avoid capture. The high altitude standoff capability significantly reduces aircraft vulnerability and detection.

The various modes of the MC-4 parachute use, such as High Altitude High Opening (HAHO) and High Altitude Low Opening (HALO), provide versatility and opportunity for controlling descent which are not possible with standard (round) or less efficient gliding parachute designs.

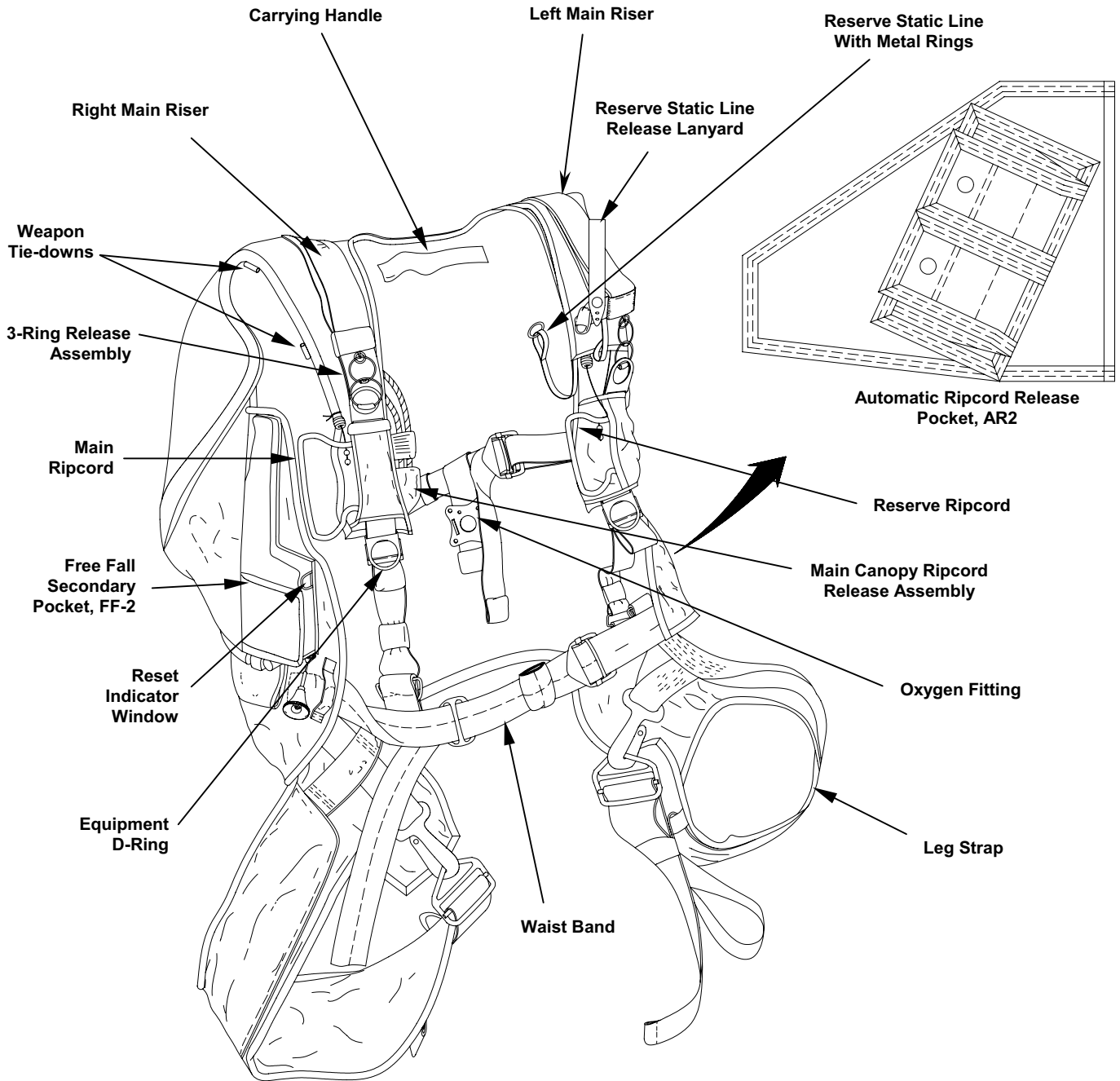

FRONT VIEW

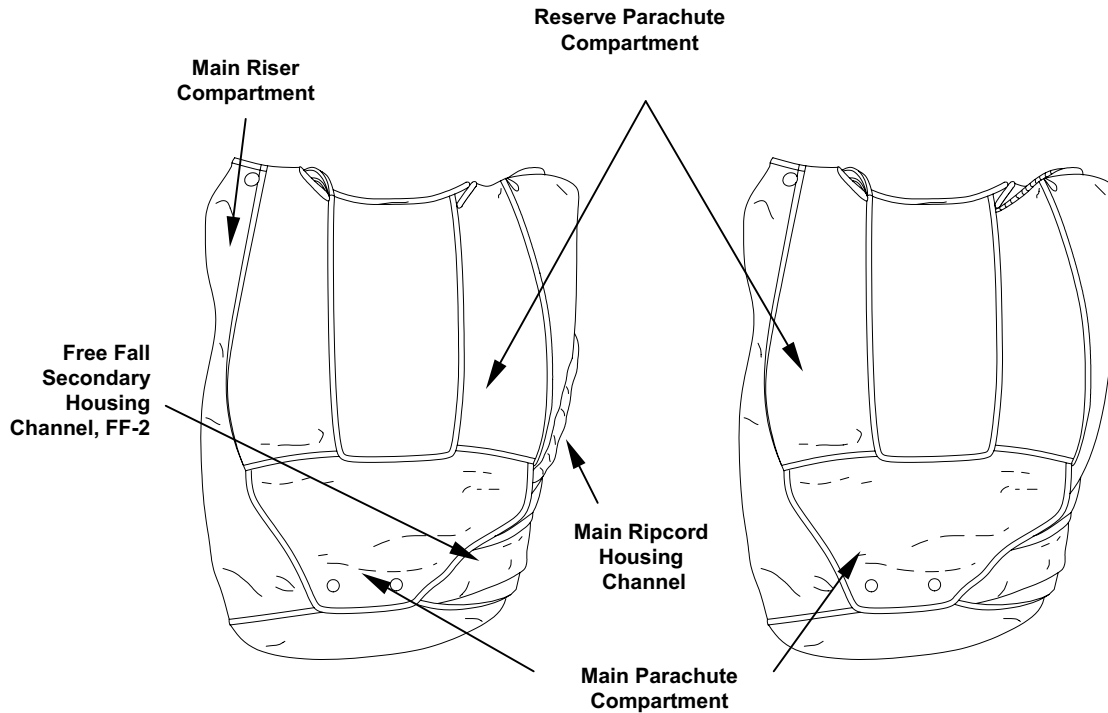

### BACK VIEW

### COMPONENTS

The ram air parachute system consists of:

1. A harness assembly compatible with a free fall secondary (FF-2) and an automatic ripcord release (AR2) automatic activation devices (AAD) and a single-point canopy release system. The harness also includes four equipment/lowering line attachment points.
2. A back-mounted container assembly designed to accommodate a main and reserve canopy situated in tandem with the reserve canopy above the main canopy. The main and reserve canopies are identical in size and performance with provisions for turning and executing maneuvers prior to landing. Both canopies are capable of three-to-one glide ratios.

### DEPLOYMENT CAPABILITY

The ram air parachute system has a deployment capability as follows:

1. The deployment of the main canopy is by either the automatic ripcord release or the main ripcord.
2. In the event the main canopy needs to be released during descent or landing, the main parachute system is equipped with a single-point canopy release system. This system releases both left and right risers from the same single point at the same instant.
3. Deployment of the reserve canopy is by either a reserve static line connected to the main canopy risers which is initiated through the single-point canopy release system or by the reserve ripcord.

4. The reserve deployment system allows reserve canopy deployment even if the reserve pilot chute becomes entangled/snagged with the parachutist or equipment.

**LOCATION AND DESCRIPTION OF MAJOR COMPONENTS**

1. Main Parachute Assembly. The main parachute assembly consists of a pilot chute connected by a bridle line to a seven-cell ram air canopy. A deployment bag is used to stow the canopy and suspension lines. The pilot chute, bridle line, and deployment bag comprise the main deployment system. The deployment bag is packed in the bottom compartment of the container assembly with risers attached to the main harness using a three-ring release system. A single-point release can be used to actuate the three-ring release system and to disengage the risers from the harness.

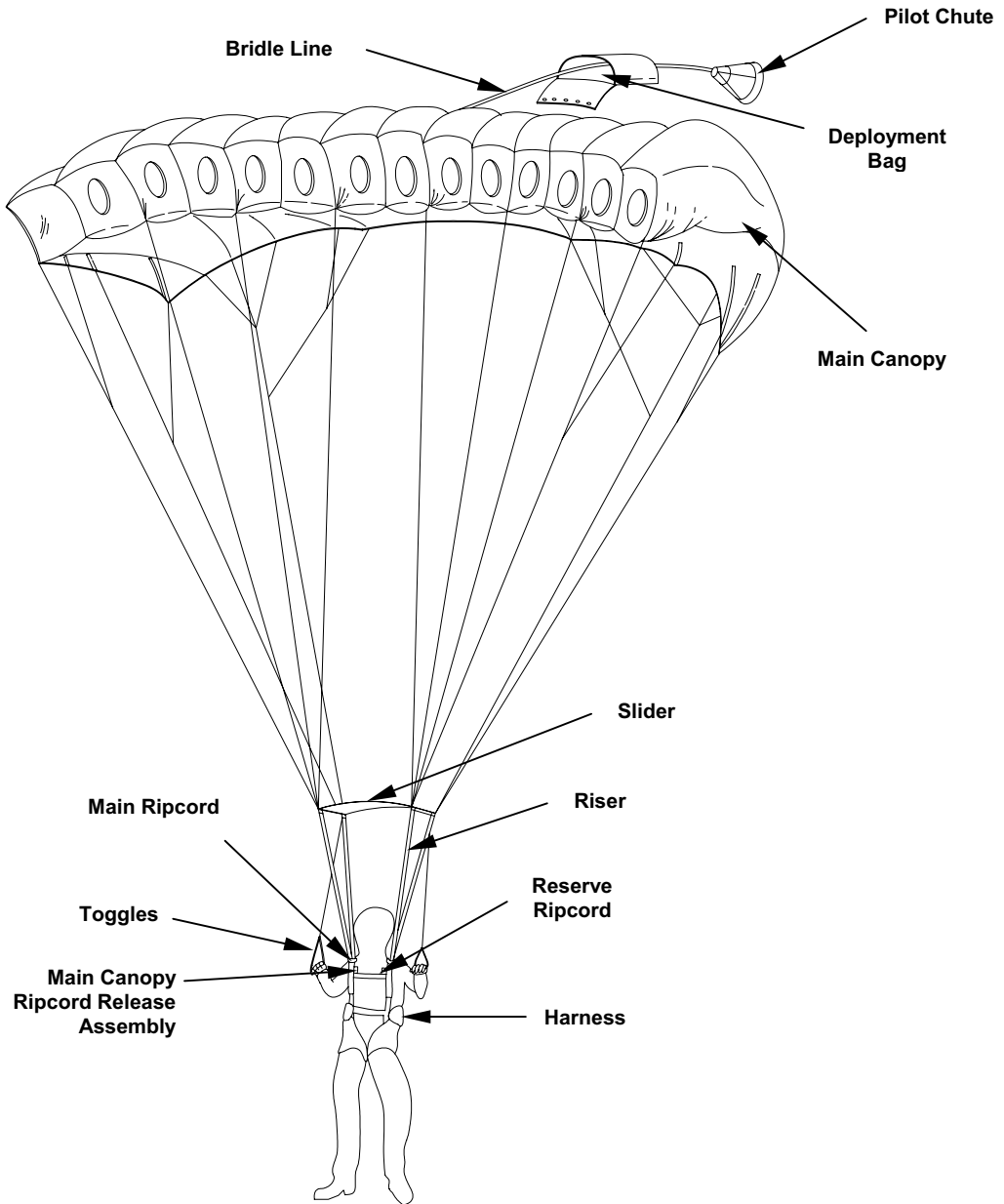



2. Main Deployment System. The main deployment system consists of the items shown below. The pilot chute has a 7-inch diameter crown, a 32-inch spiral spring, and is covered with a combination of Type I nylon cloth (0 to 5 cfm) and nylon mesh fabric. A 1-inch loop at the bottom of the main pilot chute is used to connect a 62-inch main pilot chute bridle line into the main canopy. The deployment bag measures 17 by 10-inches and is constructed of nylon cloth. A grommet in the top of the bag allows the bridle line to pass through the bag and attach to the canopy. The bag has attachment points for type II heavy-duty retainer bands, which are used to lock the bag closed and stow the suspension lines.

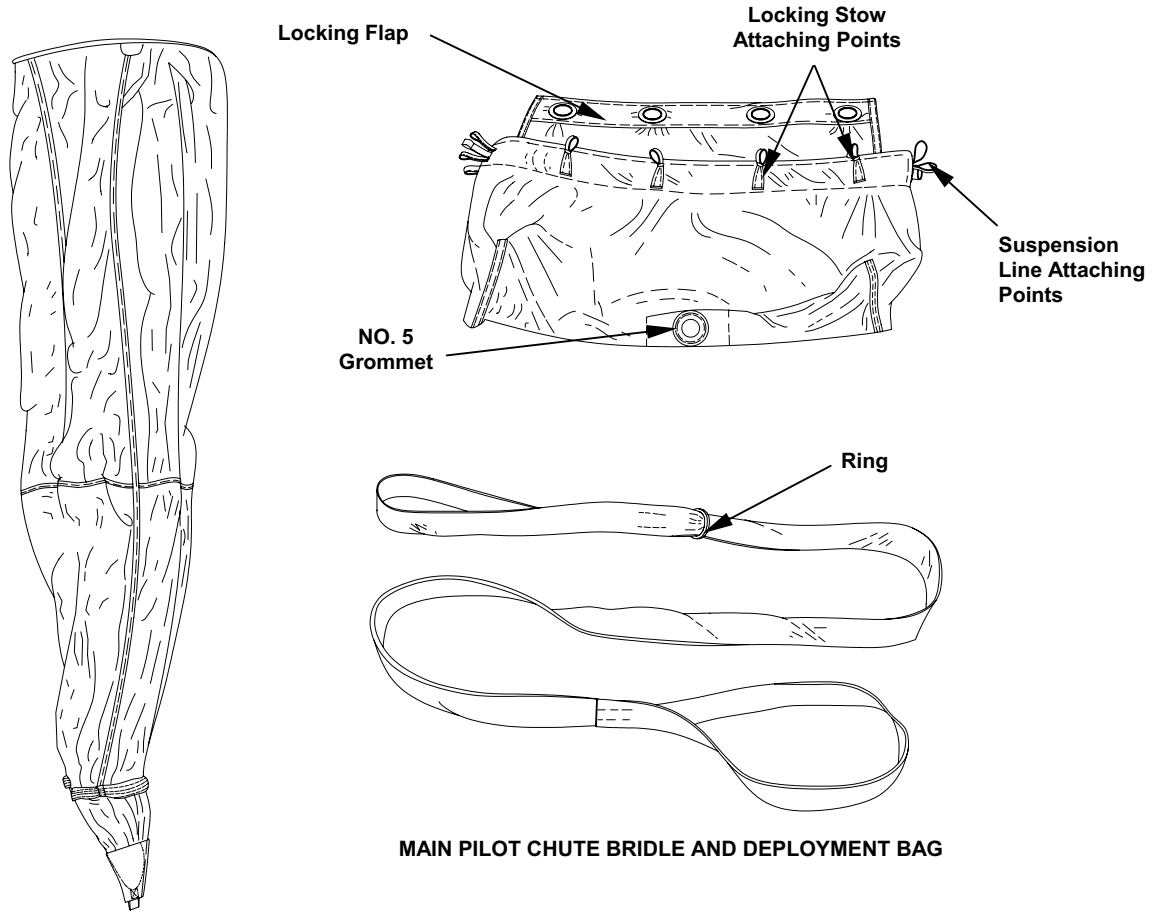

MAIN PILOT CHUTE

MAIN PILOT CHUTE BRIDLE AND DEPLOYMENT BAG

3. Main Canopy Assembly. The main canopy assembly consists of a rectangular canopy constructed of Type I nylon with heat set, stabilized, braided polyester suspension and control lines, a slider for reefing, and four barrel-nut style connector links for connection to the main risers.
  - a. Canopy. The MC-4 canopy is a semi rigid wing when inflated. It has an upper and lower surface connected by a series of ribs. This construction forms a rectangular shaped canopy with seven dual openings at the leading edge known as cells. Each cell is identified numerically, 1 through 7. The cells allow ram air pressure between upper and lower surfaces giving the canopy its shape and glide characteristics.

- (1) All ribs except the outer ribs have oval shaped crossports cut into them to allow span wise airflow. The outer ribs and alternating ribs through the canopy (eight) have load distributing tapes and attachment loops for suspension line attachment.
  - (2) The suspension lines are connected to alternate ribs at four chordwise attachment points on each rib. The lines attached to the leading edge are identified as the A lines. The lines attached aft of the A lines are the B lines, and so on to the D lines. The lines attached to the trailing edge are the control lines. Each set of lines along each rib (A, B, C, D) are identified numerically, 1 through 8.
  - (3) The center A and B lines are continuous (lines 4A, 4B, 5A, and 5B). They run directly from the fourth A line attachment point down to and around the front left connector link, and up to the fourth B line attachment point. The fifth A and B lines run similarly from the fifth B line attachment point down to and around the front right connector link and up to the fifth B line attachment point.
  - (4) Lines other than the forward center lines are cascaded to points beneath the canopy. The A lines are attached directly to one of the front two connector links. The B lines are connected to their associated A lines at a point below the canopy. The C lines run directly to one of the two rear connector links, and the D lines are attached to their associated C lines in the same way that the B lines are connected to the A lines. This cascaded method of construction reduces weight, volume, and aerodynamic drag and also contributes to structural integrity.
  - (5) Two control lines controlled at the risers are used to maneuver the canopy. Each control line is formed by attaching five cascaded lines from the trailing edge of the canopy into one main control line. Each control line then runs directly to the back of the rear risers.
  - (6) A stabilizer panel is attached to each outboard side of the canopy.
- b. Slider. The slider, used for reefing, is made of Type I nylon, is dome shaped, and measures 27 by 28-inches. All sides are reinforced with Type XII webbing. No. 8 grommets are installed at each corner.
  - c. Connector Links. Four barrel-nut style stainless steel connector links are used to connect the suspension lines to risers.

NOTE

Only No. 6 Stainless Steel Connector Links Are Authorized.

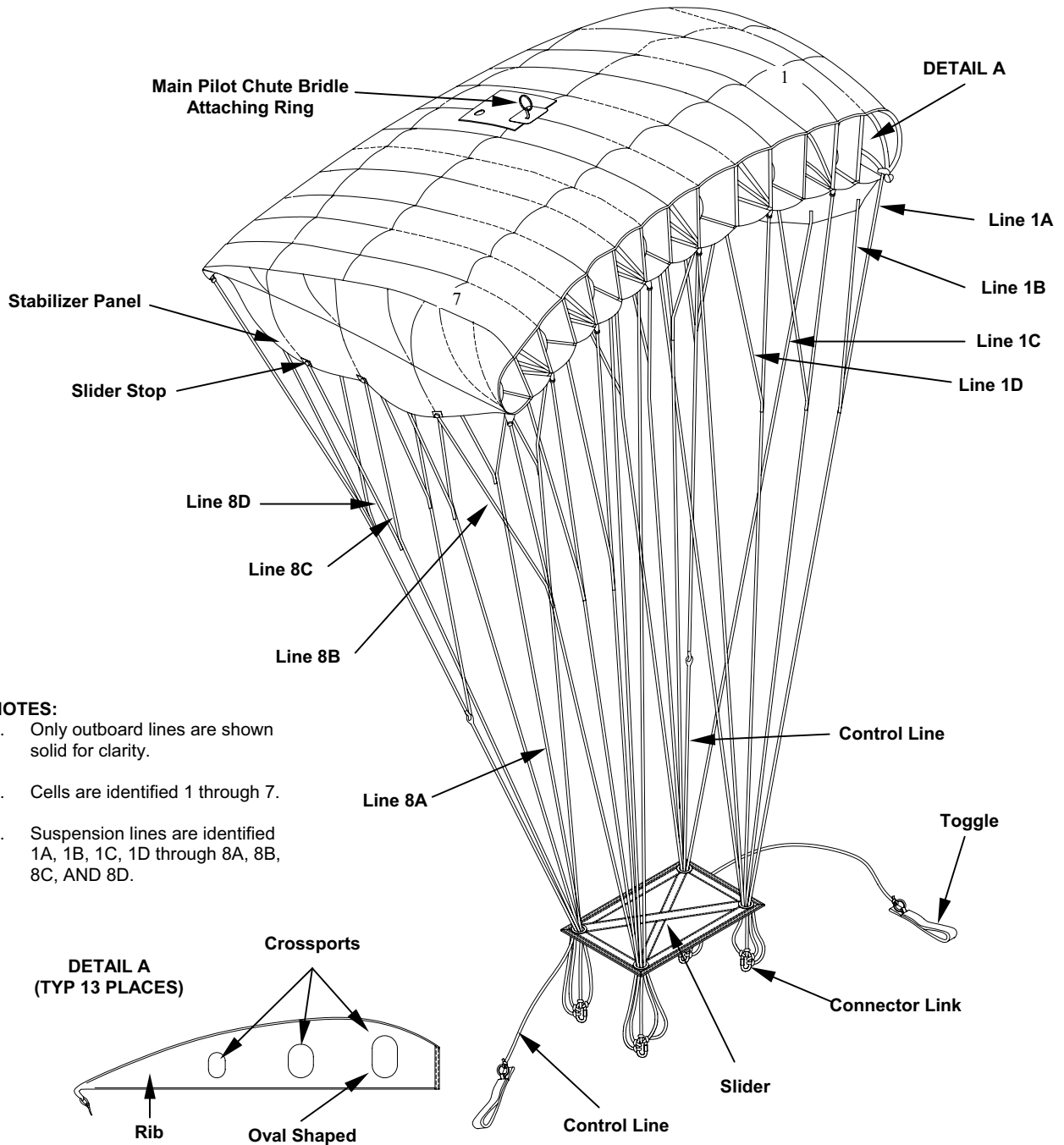

**NOTES:**

- 1. Only outboard lines are shown solid for clarity.
- 2. Cells are identified 1 through 7.
- 3. Suspension lines are identified 1A, 1B, 1C, 1D through 8A, 8B, 8C, AND 8D.

4. Container and Harness Assembly. The container and harness are an integral part of each other. The container is divided into two compartments for the main and a reserve canopy while the harness provides attachment points for the main and reserve ripcords, main risers, main canopy, and accessory attachment rings.
  - a. Container. The container, constructed of nylon duck cloth, provides an upper (reserve) and lower (main) compartment for stowage of the canopies. Protective covers are provided for the main risers and an automatic ripcord release pocket is located on the right side of the container for the FF-2, and the left side of the container for the AR2.

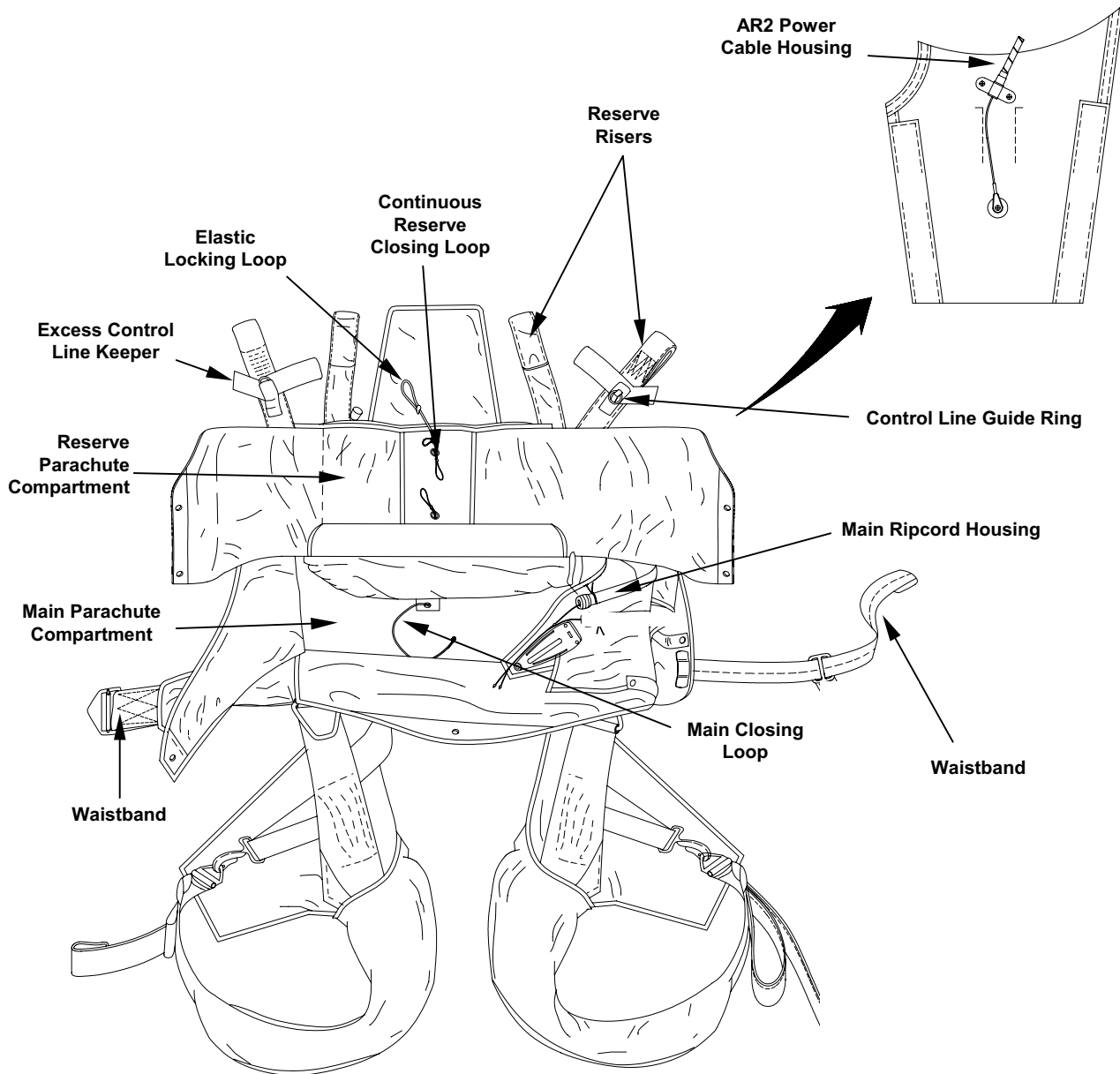

- b. Harness. The harness is constructed of Type VII nylon webbing, and is an integral part of the container. The harness includes eight adjustment points: two (2) leg connector snaps and six (6) adjusting adapters. Four (4) accessory attachment rings, one (1) each on the upper and lower lift webs, are used to accommodate rucksacks, containers, and weapons. The reserve canopy attaches to the reserve risers. The risers feature control line guide rings and covers for the control lines. The right and left lift webs serve as attachment locations for the main and reserve ripcord pockets. Also located on the lift webs are the base rings of the three-ring release assembly. These rings are used for attachment/release of the main parachute.

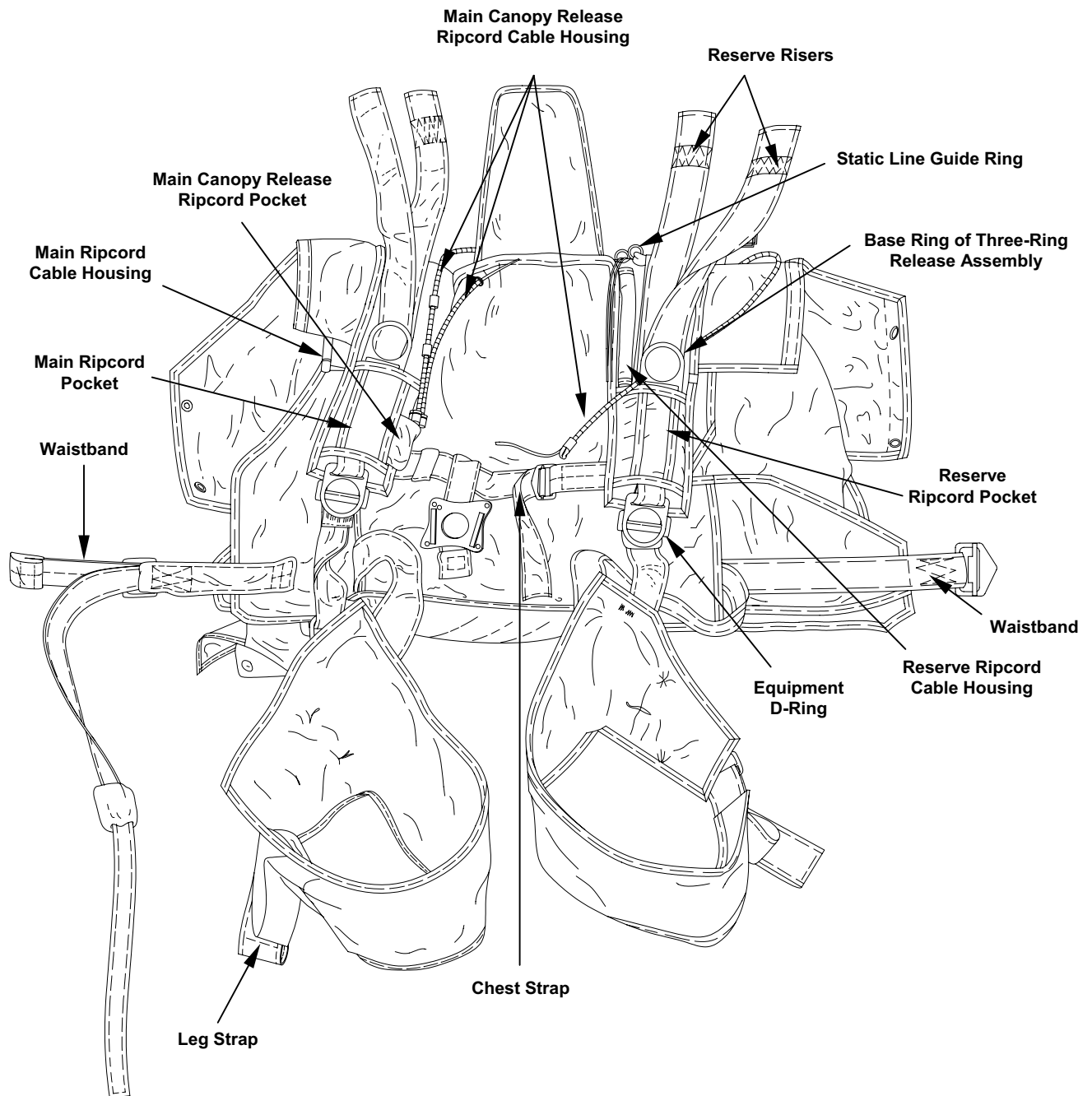

5. **Main Ripcord Assembly.** The main ripcord assembly consists of a stainless steel braided cable with a single locking pin. The cable is secured to a curved ripcord handle with two swaged balls. The terminal end of the cable also has a swaged ball.
6. **Reserve Ripcord Assembly.** The reserve ripcord assembly consists of a stainless steel braided cable with two locking pins. The cable is secured to a curved ripcord handle with two swaged balls.
7. **Main Canopy Release Ripcord.** The main canopy release ripcord consists of a red padded nylon cushion grip and lengths of plastic coated ripcord cable. A length of hook tape is sewn to the cushion grip to secure the grip to the stow pocket.

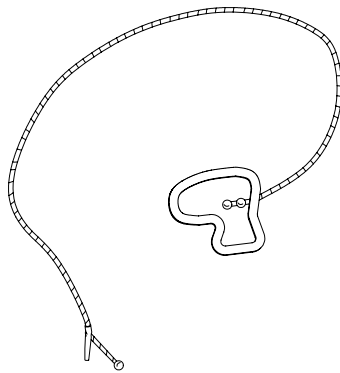
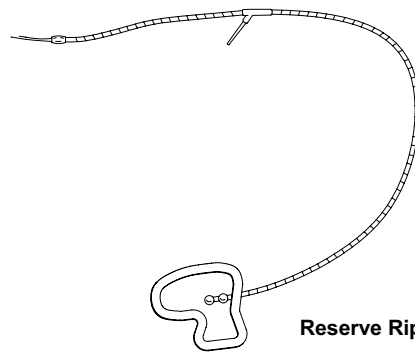
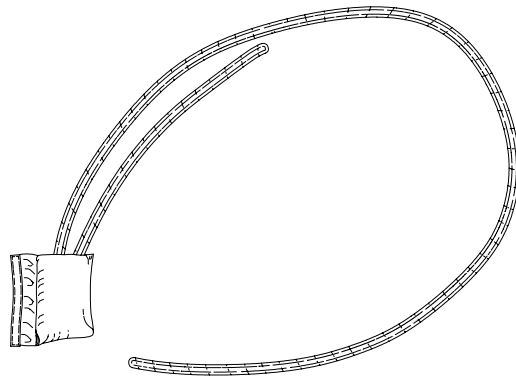
**Main Ripcord****Reserve Ripcord****Main Canopy Release Ripcord**

8. Main Riser Assembly. The main risers are constructed of Type VII nylon webbing. Each riser is 36-inches in length. The bottom end of the main risers incorporates two riser release rings, a grommet, and a main canopy release-locking loop. A channel is sewn to the back of the rear risers for stowage of the main canopy release cable. The back of the rear risers incorporates control line keepers used to stow excess control line, control line toggle keepers for stowage of control line toggles and control line guide rings.

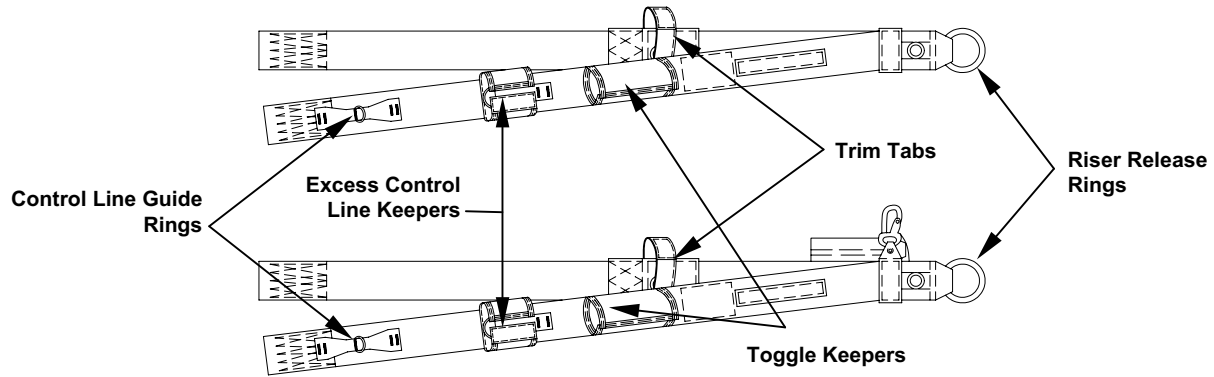

9. Free Fall Secondary FF-2. The automatic ripcord release is designed to open the main parachute compartment automatically. It consists of a release mechanism mounted in a metal case and is designed to work mechanically on barometric pressure. The arming cable, power cable, and the power cable housings are located on one side of the case. The 14-inch power cable is attached to the container base plate and the power cable is attached to the ripcord-locking pin. Refer to TM 10-1670-300-20&P for operational limitations, maintenance, and repair.

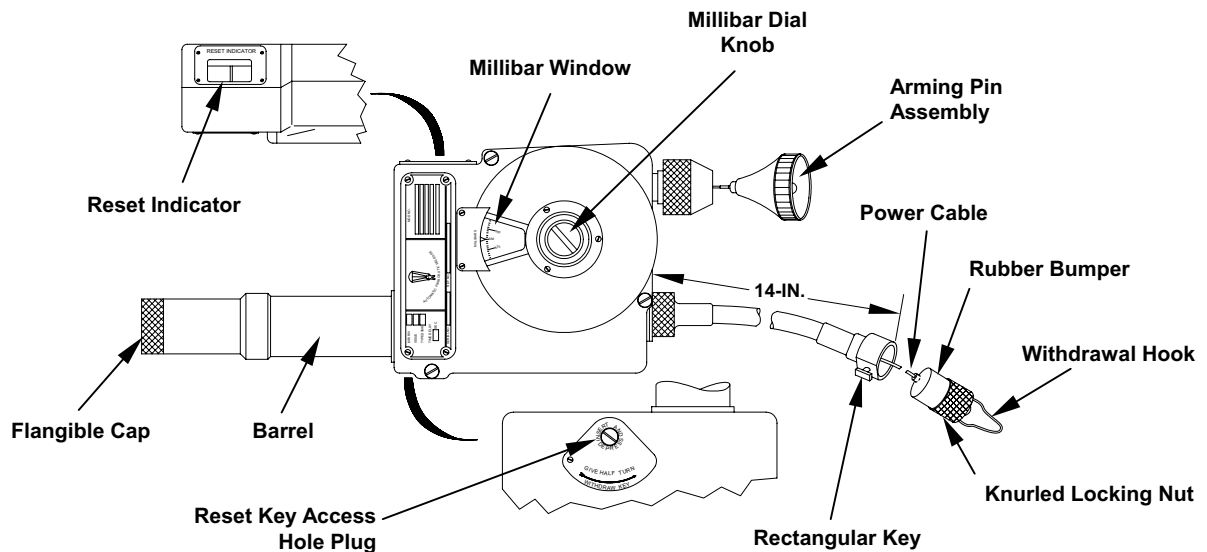

10. Automatic Ripcord Release AR2. The AR2 is designed to open the main or reserve parachute compartment automatically. The AR2 consists of an aneroid with associated mechanism, rate-of-fall sensing chamber, and a spring-loaded power cable. All components except the power cable and its flexible conduit are contained in a housing. The housing provides all required chamber, passages and mounting pads for each component. An altitude setting dial and JUMP/OFF switch are mounted on the housing. There are two power cables assemblies, one for opening the main parachute and one for opening the reserve parachute. The power cable ends in a fixed eye that connects to the parachute ripcord pin. A lanyard assembly with cap is attached to the power cable to protect the open end of the power housing when detached from the AR2. Refer to TM 10-1670-305-23&P for operational limitations, maintenance, and repair.

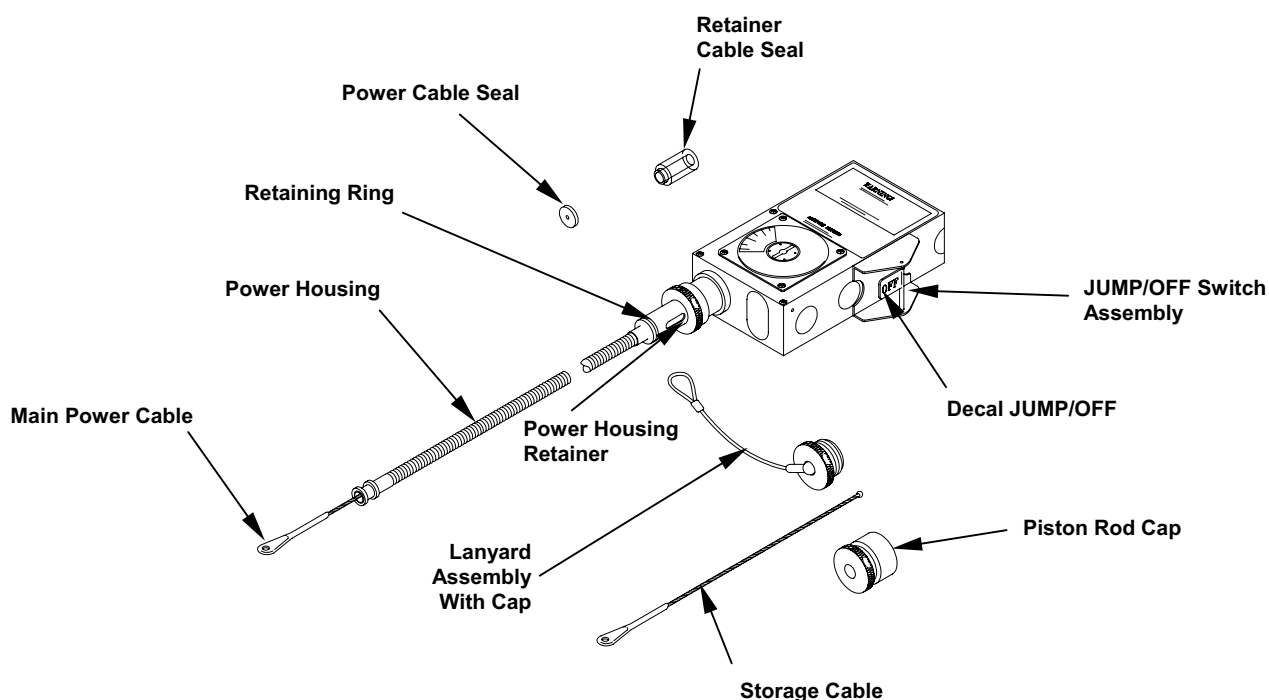

11. Reserve Parachute Assembly. The reserve parachute consists of a seven-cell ram air canopy and the reserve deployment system. The canopy is attached to the reserve risers and is packed in the upper compartment of the container. The reserve parachute can be deployed by three methods: manually by using the reserve ripcord, by the reserve static line upon release of the main parachute after pulling the main canopy release ripcord, or by actuation of the reserve mounted AAD.



12. Reserve Deployment System. The reserve deployment system consists of items shown below. The reserve pilot chute has a 7-inch diameter crown and a 19-inch spiral spring, and is covered with a combination of Type I nylon and large hole nylon mesh fabric. A 2-inch wide by 18-foot bridler line is attached to the reserve pilot chute and deployment bag. The deployment bag constructed of nylon cloth, measures 12 by 16-inches. The mouth of the bag has a channel for an elastic safety stow loop and grommets for locking the bag closed. The suspension lines are stowed in the suspension line retention pocket.

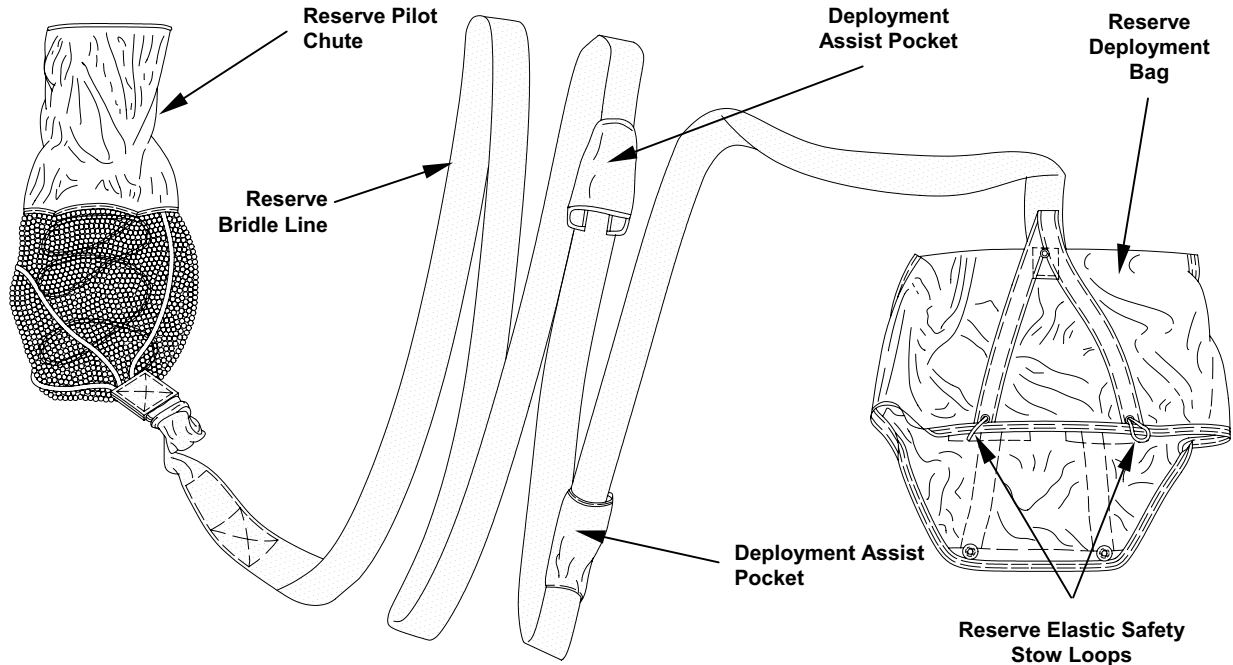

### DIFFERENCES BETWEEN MAIN AND RESERVE PARACHUTE ASSEMBLIES

The ram air parachute system consists of a main and reserve parachute mounted in tandem on the back of the parachutist. The differences between the main and reserve assemblies are as follows:

1. The main and reserve deployment systems are different and are described in items 2. and 12., above.
2. The main parachute may be deployed by a ripcord or by an Automatic Ripcord Release (ARR).
3. The reserve parachute may be deployed by ripcord, a left main riser actuated reserve static line, or by the ARR.
4. The main risers have excess control line keepers, toggle keepers and control line guide rings; the reserve risers have excess control line keepers and the control line guide rings only.
5. There is an 8-inch difference in control line length. The main canopy control lines are longer than the reserve canopy control lines.
6. The main ripcord has a single locking pin the reserve ripcord has two locking pins.

**EQUIPMENT DATA**

Refer to Table 1 for performance data for the main and reserve parachute assemblies.

**Table 1. Main and Reserve Parachute Characteristics**

<b>Performance/Description</b>	<b>Characteristics</b>
Lift/Drag Ratio, L/D	3 to 1
Span	28.5-ft
Chord	13-ft
Area	370 sq ft
Maximum Suspended Weight	360-lbs
Forward Speed Range	10 to 25 mph
Rate of Descent	Variable Full Flight to Fully Flared Landing
Full Flight	14 to 16 fps
50% Brakes	6 to 10 fps
100% Brakes	2 to 6 fps
Fully Flared Landing Touchdown	0 to 4 fps (if executed properly)
Deployment Altitude Range	2000-ft AGL to 25,000-ft MSL
Deployment Velocity Range	0 to 150 KIAS

**SAFETY, CARE, AND HANDLING**

The following subparagraphs summarize the safety, care, and handling requirements for the parachute assembly.

**Safety.** It is imperative that you observe all safety precautions specified on the warning page in the front of this manual. You must also observe specific warnings and cautions specified throughout this manual. The warnings are provided to tell you how to protect yourself from death or serious injury.

**Care and Handling.** Observe the following precautions:

1. Use care in handling packed parachutes as metal parts could cause personal injury.
2. Remove all jewelry when packing or performing maintenance on the parachute. Damage to the canopy materials could result from watches, rings, bracelets etc.
3. Avoid grabbing the ripcord grip or grip-retaining pocket when handling a parachute.
4. Use every effort to protect the parachute from the weather elements, dust, dirt, oil, grease, and acids

5. Place unpacked parachutes in aviator kit bags.
6. Cover canopy during periods of inactivity. Avoid exposing canopy to sunlight, inspection lights, or fluorescent lights for prolonged periods. Nylon material is subject to deterioration under ultraviolet light.
7. Use a heated building to store parachutes when available. Store parachute in a dry, well-ventilated location protected from pilferage, dampness, fire, dirt, insects, rodents, and direct sunlight.
8. Canopies should be slowly removed from water immersion by tail section first so water will drain from the open cells and not warp the construction.

**END OF WORK PACKAGE**



---

**MC-4 RAM AIR FREE-FALL PERSONNEL PARACHUTE SYSTEM  
THEORY OF OPERATION**

---

**MC-4 RAM AIR FREE-FALL PERSONNEL PARACHUTE SYSTEM THEORY OF OPERATION**

The MC-4 parachute system is a dual parachute system with similar main and reserve canopies. Both parachutes are located on the back of the parachutist leaving the front clear for mounting additional equipment or instrumentation. The principles used in its construction allow it to have high forward speed, a 3 to 1 glide ratio, and excellent maneuverability. In an emergency, the ram air system uses a single point canopy release to jettison the main canopy and deploy the reserve canopy. The reserve parachute uses a free bag deployment system, a high drag pilot chute, and an 18-foot bridle line with deployment assist pockets; each designed to increase the reliability of the reserve parachute in an emergency.

1. **Canopy.** The ram air canopy incorporates spanwise construction. By running fabric from side-to-side instead of from front-to-rear, the size of each cell is not limited to the width of the cloth. This method of construction results in a decrease in weight and bulk and a higher level of safety. 13-airfoil section ribs dividing the canopy into 7 cells attach the upper and lower surfaces of the canopy. Each rib has three (3) elliptical crossports cut into it. These crossports allow air to flow spanwise through the canopy to equalize parachute pressurization. During descent, air enters the cell openings at the leading edge, pressurizing each cell and giving the canopy its shape and glide characteristics. A glide ratio of 3-feet of lateral movement to 1-foot of the descent is obtained. The rate of descent is determined by the suspended weight as well as the angle of the parachute with respect to the ground and distance that the trailing edge is pulled down. The parachute is controlled and maneuvered by using trim tabs and control lines. The canopy has two control lines that connect to five (5) cascaded lines attached to the trailing edge of the outer cells. By pulling on either the right or left control line, the canopy will turn in that direction. By pulling down on both control lines simultaneously, the rate of descent and the forward speed are decreased. Trim tabs are used to change the glide angle of the MC-4 canopy.
2. **Slider.** A slider is used with the ram air parachute system to reef the opening of the canopy and reduce opening loads. This allows for a more controlled opening of the canopy. During packing, the slider is placed at the lower surface of the canopy. During opening, the slider controls the drag area of the parachute as it slides down the suspension lines.
3. **Stabilizer Panels.** During parachute descent, turbulent air can be produced at each side of the canopy, creating instability. The addition of stabilizer panels to each side helps reduce turbulent airflow, thus stabilizing the canopy.
4. **Deployment Brakes.** Without deployment brakes, the parachute deployment becomes unreliable. Deployment brakes lock down the trailing edge of the parachute using the control lines during deployment. They are set by pulling each control line down through the guide ring and locking each in place by using the appropriate toggle. The control line remains locked in place until manually released by the parachutist after deployment.

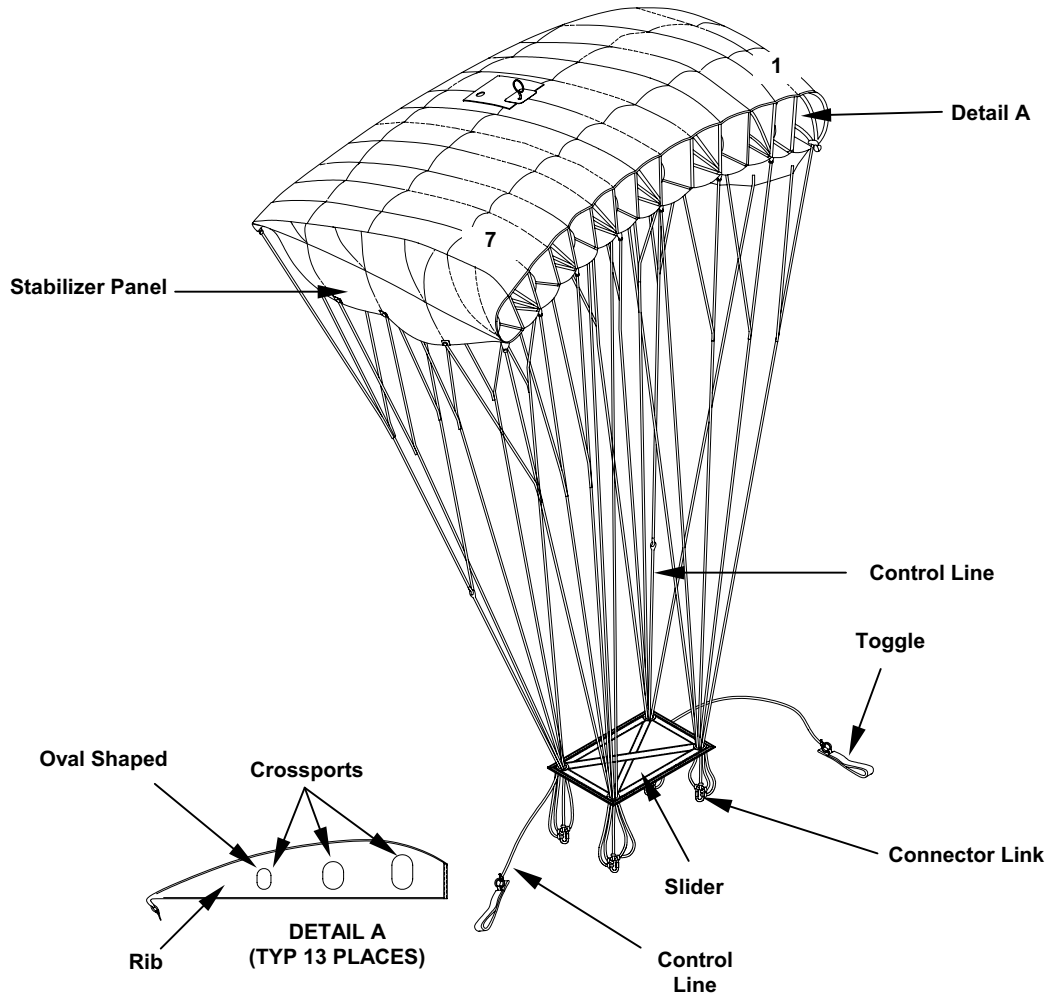

5. Reserve Deployment System. The reserve deployment system consists of the items shown below. The reserve pilot chute is constructed to provide a maximum amount of drag during a low speed canopy deployment. The reserve pilot chute is connected to an 18-foot bridle line with deployment assist pockets that, in case the pilot chute is unable to deploy due to entanglement, should alone create sufficient drag to deploy the reserve canopy successfully. The deployment bag is not attached to the canopy, allowing the parachute to deploy even in situations of pilot chute entanglement with the parachutist or a "horseshoe" malfunction.

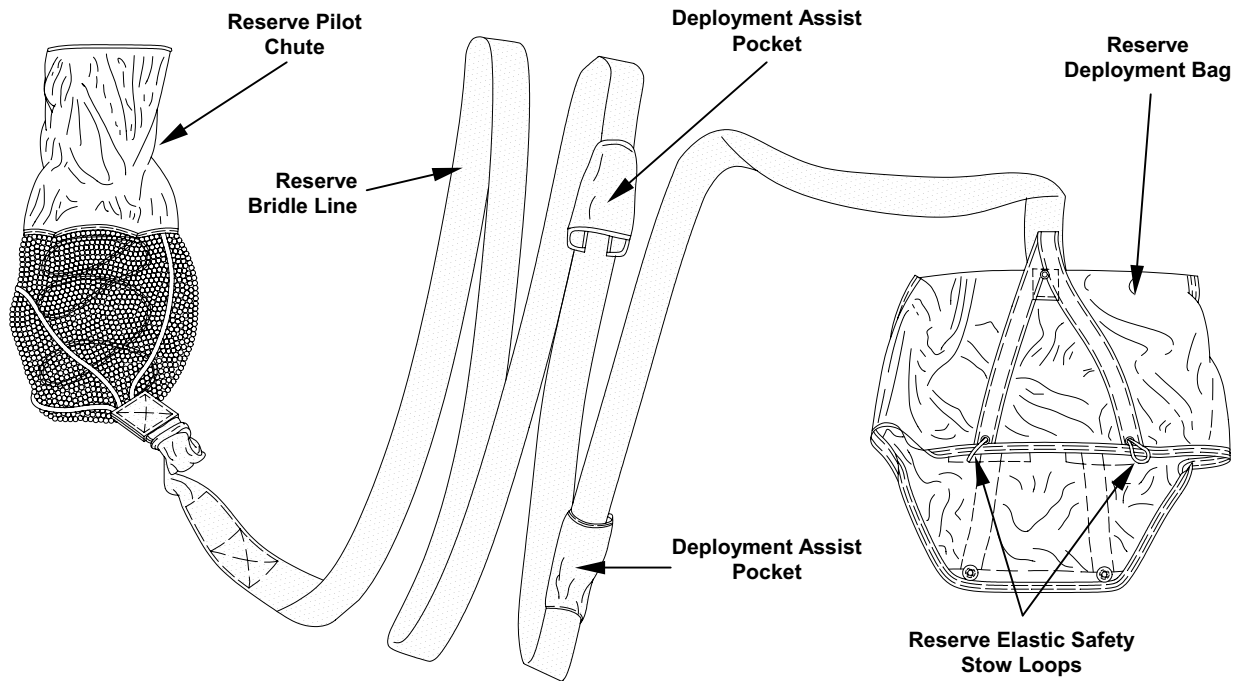

6. Main Canopy Release Ripcord. The ram air parachute design features a single-point release that is capable of releasing the main canopy and deploying the reserve in one smooth function. In the event of a main parachute malfunction, the parachutist has only to withdraw the main canopy release ripcord (as shown on the following page). Once withdrawn, the two rings on each riser are released from the base ring, releasing the main canopy. If still attached to the main risers, the reserve static line will withdraw the reserve ripcord pins, deploying the reserve parachute.

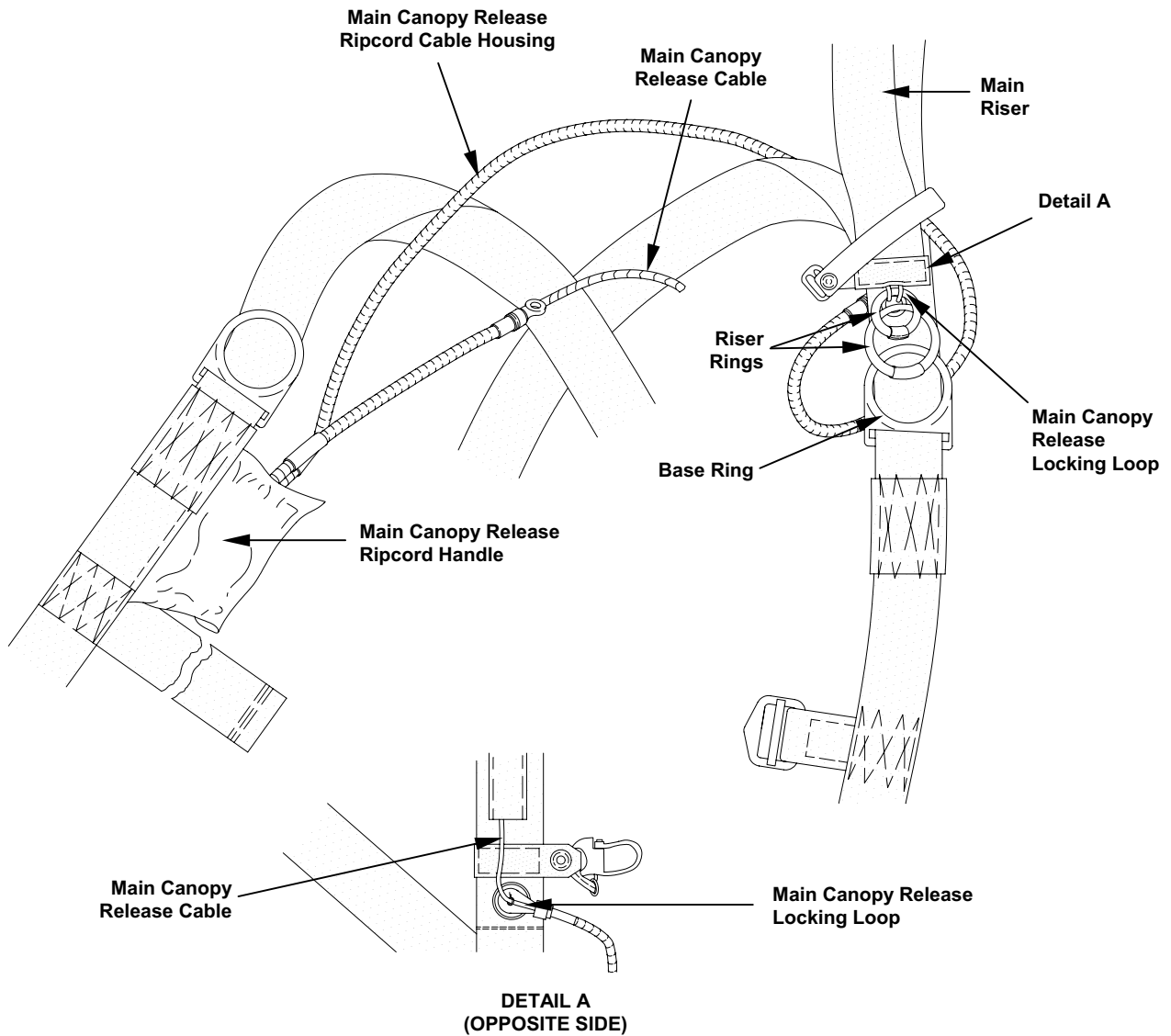

END OF WORK PACKAGE



**CHAPTER 2**  
**OPERATOR MAINTENANCE INSTRUCTIONS**  
**FOR**  
**MC-4 RAM AIR FREE-FALL**  
**PERSONNEL PARACHUTE SYSTEM**



---

**MC-4 RAM AIR FREE-FALL PERSONNEL PARACHUTE SYSTEM  
SERVICE UPON RECEIPT**

---

**THIS TASK COVERS:**

- Overview
  - Initial Receipt
  - Receipt of Used Parachute
  - After-Use Receipt
- 

**INITIAL SETUP:****Tools**

Needle, Tacking (Item 29, WP 0063 00)

**Materials/Parts**

Tape, Lacing and Tying (Item 33, WP 0076 00)

**Personnel Required**

92R (10) Parachute Rigger

---

**Equipment Condition**

All equipment shall be serviceable and ready for use.

**OVERVIEW**

This chapter contains information necessary to maintain the MC-4 Ram Air Free-Fall Personnel Parachute, on the Unit and Direct Support (DS) maintenance levels, in accordance with the Maintenance Allocation Chart (MAC) for the equipment. It includes the following:

**Common Tools and Equipment.** For authorized common tools and equipment, refer to the Modified Table of Organization and Equipment or Table of Distribution and Allowances (MTOE/TDA) applicable to your unit.

**Special Tools, TMDE, and Support Equipment.** A repair parts and special tools list (RPSTL) is included in WP 0064 00 of this manual. Tools or equipment that must be fabricated are listed in WP 0077 00 of this manual.

**Repair Parts.** Repair parts are listed and illustrated in WP 0065 00 through WP 0072 00 of this manual.

**INITIAL RECEIPT**

The following describes the procedures for processing parachutes upon initial receipt.

**General Procedures for Air Delivery Equipment.** When air delivery equipment is initially procured from a supply source and issued to a using unit, the item(s) will be unpacked from the shipping container(s) and inspected by a qualified parachute rigger (MOS 92R, 921A, 92D). The inspection performed will be a technical/ rigger-type inspection and will be conducted as outlined in the Preventive Maintenance Checks and Services (PMCS) procedures. Upon completion of the inspection, the item(s) will be tagged as prescribed in DA PAM 738-751. Serviceable equipment may then be entered either into storage or into use in airdrop operations, as applicable. An unserviceable item will be held and reported, in accordance with DA PAM 750-8/ MCO 4855.10B.

**Inspection Personnel.** Personnel other than parachute rigger personnel may assist in the unpacking process of initially received parachutes as directed by the local air delivery equipment maintenance officer. However, the parachute maintenance officer ensures that the entire unpacking effort is conducted under the direct supervision of a qualified rigger (92R, 921A, 92D) in accordance with AR 750-32.

**Configuration Condition.** Acceptance of new equipment from the manufacturer is based upon inspections made of sample lots that have been randomly selected in accordance with military standards. It is incumbent upon the using activity personnel to bear this in mind whenever equipment is first placed in service. Changes will sometimes evolve from the original equipment design and sometimes contractors are authorized deviations in material and construction techniques. Air delivery equipment that has been in the field cannot be expected to meet exacting manufacturing specifications; however, the equipment should closely reflect desired design characteristics. Since repairs, modifications, and/or changes can alter or detract from the configuration originally desired, such equipment shall be airworthy, safe, of the desired configuration, and adequate for intended use.

**Marking Parachutes.** Prior to being placed into service, personnel parachutes that have had no previous use will be marked to reflect the date of entry into service. The marking will be made on the canopy information data block by stenciling the lettering in ½-inch characters, using the marking and restenciling repair procedures detailed in WP 0017 00. Other applicable parachute components will be marked adjacent to existing data. The stenciled data will appear on IN-SVC followed by the date, which will indicate the month and calendar year, such as "Jan. 99". Ensure the added marking does not infringe upon, or obliterate, any original data on the information data block.

**Parachute Log Record.** The Army Parachute Log Record, DA Form 3912, AFTO 391, and NAVWPNCEN or NAWCWPNS CL 13512/11 (Premeditated Parachute Record) are history-type maintenance documents that accompany the parachute canopy and pack tray assemblies through the period of service of the individual assembly. The log record provides a means of recording maintenance actions performed on a parachute canopy assembly. Normally, a log record is initiated and attached to a pack tray upon receipt by a using unit. However, if the item is subjected to alteration or modification by a maintenance activity during the interim period from date of manufacture to receipt by a using unit, the log record will be prepared by the activity performing the maintenance function. Once initiated, a log record will be attached to, and contained in, an affixed parachute log record/ inspection data pocket, until such time as the parachute canopy assembly is destroyed or rendered unfit for further use or repair.

Additionally, should an item that requires a log record, be transferred from one unit to another, the log record for the parachute assembly will accompany the item in the transfer action. A prepared log record will not be removed or separated from a parachute, and especially a packed parachute, except as directed by the local air delivery equipment maintenance officer.

A log record that is illegible, lost, damaged, soiled, or precludes further entries due to lack of space, will be replaced upon the next repack or inspection, as applicable, with a serviceable item from stock.

**Installing Attaching Tie.** Install attaching tie as follows:

1. Cut a 30-inch length of tape, lacing and tying (super tack), and double the lacing length.
2. Pass the looped end, of the doubled lacing length, around the centerfold of the log record and form a slip loop on the outside, at the log record top.

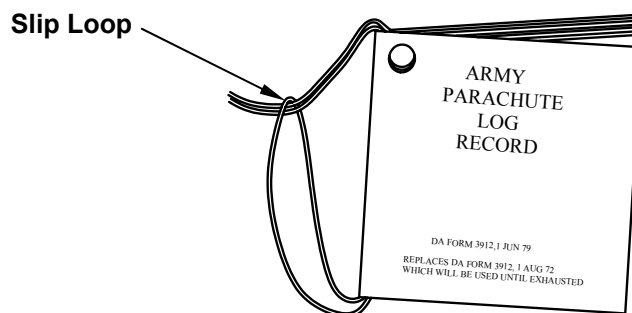

**Forming Slip Loop on Log Record Outside**

3. Pass the lacing length running ends through the corner-attaching hole, from the front cover of the log record.

Corner Attaching Hole

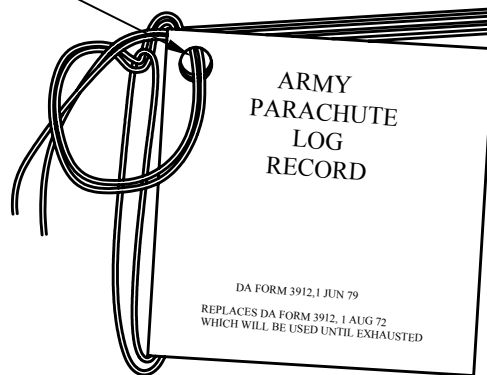

**Passing Lacing Loose Ends Through Corner Attaching Hole**

4. Ensure the running ends are routed over that part of the lacing length located inside the log record book along the log record centerfold.

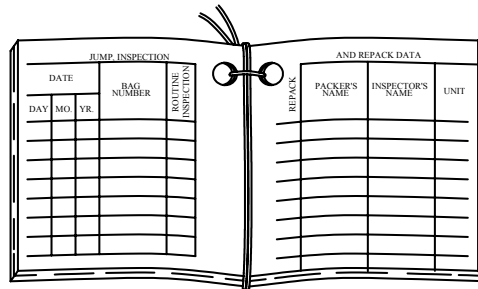

**Routing Lacing Loose End Through Log Record Centerfold**

5. Complete the attachment tie by making a half hitch on top of the slip loop made in step 2., above.

Half Hitch

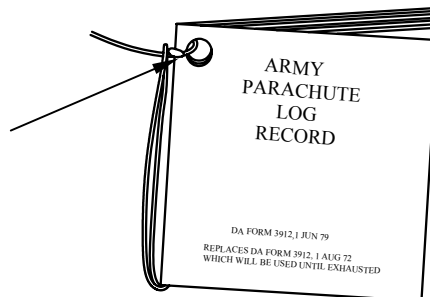

**Log Record Attachment Tie Completed**

6. Thread one running end of the log record attachment tie in a tacking needle and pass the tacking needle, with attached end, through the edge binding of the applicable parachute log record/ inspection data pocket.
7. Remove the lacing end from the tacking needle; make a finished 10-inch-long log record attaching loop by securing the two lacing ends together with an overhand knot.
8. Insert the log record into the pocket and secure the record within the pocket using the pocket flap and applicable type flap fastener.

NOTE

Log record book entries will be made with a suitable type blue or black marking device that cannot be erased (no felt tip markers).

**Accomplishing a Log Record.** Upon completion of the first technical/ rigger-type inspection, the individual performing the inspection will initially prepare a log record for an individual parachute and accomplish subsequent record entries using the following procedures:

1. Inside front cover. Using the information provided on the parachute canopy data block, make the following entries on the inside front cover of the log record. Entries may be continued on the inside of the back cover, if necessary.

SERIAL NO. \_\_\_\_\_ ○

TYPE \_\_\_\_\_

PART NO. \_\_\_\_\_

DATE OF MFG. (Month & Year) \_\_\_\_\_

MANUFACTURER \_\_\_\_\_

CANOPY CONTRACT NO. \_\_\_\_\_

MO/YR CANOPY PLACED IN SERVICE \_\_\_\_\_

STATION & UNIT \_\_\_\_\_

\_\_\_\_\_

\_\_\_\_\_

(Continued on inside back cover)

- a. Serial number. Enter the parachute canopy assembly serial number.

**NOTE**

A parachute canopy serial number is recorded in a log record as a method of establishing control for maintenance, Equipment Improvement Report (EIR) and Product Quality Deficiency Report (PQDR) documentation, and to ensure the correct original record is reattached should the record become detached. A canopy serial number will not be used for property accountability, except in test projects or other special instances.

- b. Type. Enter the parachute type.
  - c. Part number. Enter the part number of the parachute canopy.
  - d. Date of manufacture. Enter the month and year the parachute canopy was manufactured.
  - e. Manufacturer. Enter the name of the parachute canopy manufacturer.
  - f. Canopy contract number. Enter the entire contract number specified for the parachute canopy.
2. Station and unit. Enter the name of the station and unit to which the parachute canopy is currently assigned. When a parachute is transferred permanently to another station and/or unit, line out the original entry and enter the name of the receiving station and/or unit.
3. Inside back cover. Entries may be continued on the inside back cover, if necessary.

<input type="radio"/>	STATION & UNIT (Continued)
_____	
_____	
_____	
_____	
_____	
_____	
_____	
_____	
_____	
_____	

4. Modification Work Order (MWO) Compliance Record Page. When a modification is performed on a parachute canopy, make the following entries on the Modification Work Order Compliance Record pages of the Log Record.

Modification Work Order		Compliance Record					
MWO Number	MWO Title	Modified By (Name)	INSP By	UNIT	Date		
					Day	MO.	YR.
① 10-1670-213-24 15 JULY 01	AR2 CABLE MOD	Venckus	TK	SBCCOM	24	3	02
② 10-1670-213-24 15 JULY 01	AR2 CABLE MOD	C/W	TK	SBCCOM	24	6	02

1. Modification Work Order Compliance Completed.

2. Modification Completed By Unknown Due To Lost Original Log Record.

- a. MWO number. Enter the publication number and date of the MWO that describes the MWO (1 above).
- b. MWO title. Enter a short, abbreviated title extracted from the MWO prescribing the work.
- c. Modified by. Enter the last name of the individual who has performed the modification. If the original log record for the parachute has been lost, and it has been ascertained through inspection that a particular modification has been accomplished, the entry for this column will be Complied With (CW), (2 above), which signifies the applicable MWO has been complied with.
- d. Inspected by. The individual who accomplished the inspection required after modification will sign this entry with his last name only.
- e. Unit. Enter the unit designation responsible for performing the MWO or in the event of a lost Log Record, the unit to which the inspector is assigned.
- f. Date. Enter the day, month, and year the modification was completed.

UNIT & INTERMEDIATE	REPAIR & INSPECTION DATA				
TYPE OF REPAIR	INSP BY	UNIT	DATE		
			DAY	MONTH	YEAR
INITIAL INSPECTION	Venckus	SBCCOM	12	2	01
1 SEC and 4 Lines Replaced	Cravel	SBCCOM	3	3	01
MWO 10-1670-287-20-1	Benson	SBCCOM	10	4	01

- 1. Completion of Initial Inspection
- 2. Repair Accomplishment
- 3. MWO Inspection Compliance



5. Unit and Direct Support Repair and Inspection Data. When a parachute assembly is initially received from a supply source and a technical/rigger type inspection is performed, document the inspection accomplishment on the Unit and Intermediate Repair and Inspection Data page of the individual Parachute Log Record. Additional entries will also be made on this page each time the canopy assembly is repaired or is administered an inspection in compliance with a Maintenance Advisory Message (MAM) or Ground Precautionary Message (GPM) as follows:
  - a. Type of repair. Enter the type of repair, completion of initial inspection, repair accomplishment, Maintenance Advisory Message (MAM) or Ground Precautionary Message (GPM) compliance.
  - b. Inspection by. The individual who accomplished the inspection required will sign this entry with last name only.
  - c. Unit. Enter the unit designation responsible for performing the type of repair.
  - d. Date. Enter the day, month, and year the repair was performed.
  - e. Note page. A page is provided at the back of a parachute log record to accommodate recording of additional data pertinent to the serviceability of a parachute canopy assembly. This shall also include the month and year the item was placed in service.

 <b>NOTES</b>
RISER MFG DATE: 7 JAN 2000
PLACED IN SERVICE: 7 JAN 2001
IMMERSED IN SALT WATER: 26 JULY 2001
RINSED: 27 JULY 2001

**NOTE**

A parachute log record that is completely filled out, lost, illegible, or in an otherwise unserviceable condition, will be replaced with a serviceable log record.

6. Replacing a filled out or unserviceable log record.
  - a. Using a suitable blue or black marking device, enter NEW BOOK on the outside front cover of the replacement log record.
  - b. Transcribe the information from the inside front cover of the original log record to the inside front cover of the replacement log record. If the original data is illegible or missing, use the canopy information data block to collect the required data.

- c. In the replacement log record; transcribe the initial and last entry made on the Jump, Inspection, and Repack Data page of the original log record.
  - d. Transcribe all data from the remaining pages of the original log record; to the appropriate pages of the replacement log record.
  - e. After all original data has been transcribed destroy the original log record.
7. Replacing a lost log record.

NOTE

Any time a log record is discovered missing from a parachute, a replacement log record will be initiated during repack or inspection, as applicable.

- a. Using a suitable blue or black marking device, enter NEW BOOK on the front cover of the replacement log record.
- b. Accomplish the log record inside front cover as prescribed above.
- c. The age life of the canopy will be obtained from the date placed in service (initial) and other applicable data on the Jump, Inspection, and Repack Data page of the log record, as detailed above. Enter IN, if the date placed in service is known. If not known, enter UNK.
- d. If it can be ascertained by inspection that a previous MWO has been complied with, applicable entries will be made on the appropriate page of the replacement log record.
- e. Attach the replacement log record to the log record/inspection data pocket using the procedures above.

**RECEIPT OF USED PARACHUTE.** Upon initial receipt of used parachute, proceed as follows:

1. Follow "GENERAL PROCEDURES FOR AERIAL DELIVERY EQUIPMENT" found in WP 0002 00, and check each component for excessive wear and tear.
2. If defects or damages are discovered, process the parachute for maintenance at the maintenance level assigned by the Maintenance Allocation Chart (MAC) WP 0063 00.

**After-Use Receipt.** When the parachutist receives a parachute at the maintenance activity following its use during air delivery, it must be given a shakeout and aired (WP 0009 00), and if necessary, cleaned (WP 0010 00) before it can be returned to service. If a parachute is issued but is not used, it does not need to be given a shakeout; however, it must be given a routine inspection by a qualified parachute rigger before it is placed in a Ready for Issue (RFI) status.

**END OF WORK PACKAGE**

**MC-4 RAM AIR FREE-FALL PERSONNEL PARACHUTE SYSTEM  
ASSEMBLY – RESERVE PARACHUTE**

**THIS TASK COVERS:**

- Ripcord Test
- Layout
- Attachment of Canopy to Risers
- Application of Markings
- Installation of Safety Stow; Elastic Loop in Deployment Bag
- Attachment of Control Lines to Control Toggles
- Canopy Trim Check
- Spanwise Line Check

**INITIAL SETUP:**

**Tools**

- Brush, Stenciling (Item 5, WP 0063 00)
- Inspection Kit, Ripcord Grip (Item 21, WP 0063 00)
- Machine, Stencil Cutting (Item 26, WP 0063 00)
- Needle, Tacking (Item 29, WP 0063 00)
- Tape Measure (Item 42, WP 0063 00)
- Wrench, <sup>7</sup>/<sub>16</sub>-IN., Open-End (Item 45, WP 0063 00)

**Personnel Required**

- 92R(10) Parachute Rigger
- 92R(20) Parachute Rigger

**Materials/Parts**

- Ink, Marking, Parachute (Item 25/26, WP 0076 00)
- Stencil Board, Oiled (Item 31, WP 0076 00)
- Tape, Lacing and Tying (Item 33, WP 0076 00)
- Tape, Pressure-Sensitive, Yellow, <sup>1</sup>/<sub>2</sub>-IN. Wide (Item 38, WP 0076 00)

**Equipment Condition**

Stretch canopy and suspension lines full length in packing area.

**RIPCORD TEST**

1. Perform a ripcord test as follows:
  - a. Insert <sup>1</sup>/<sub>2</sub>-inch of a locking pin end into the hole of a fixed ripcord locking pin test block (as shown in A below). Ensure the test block is firmly secured in the fixed position.

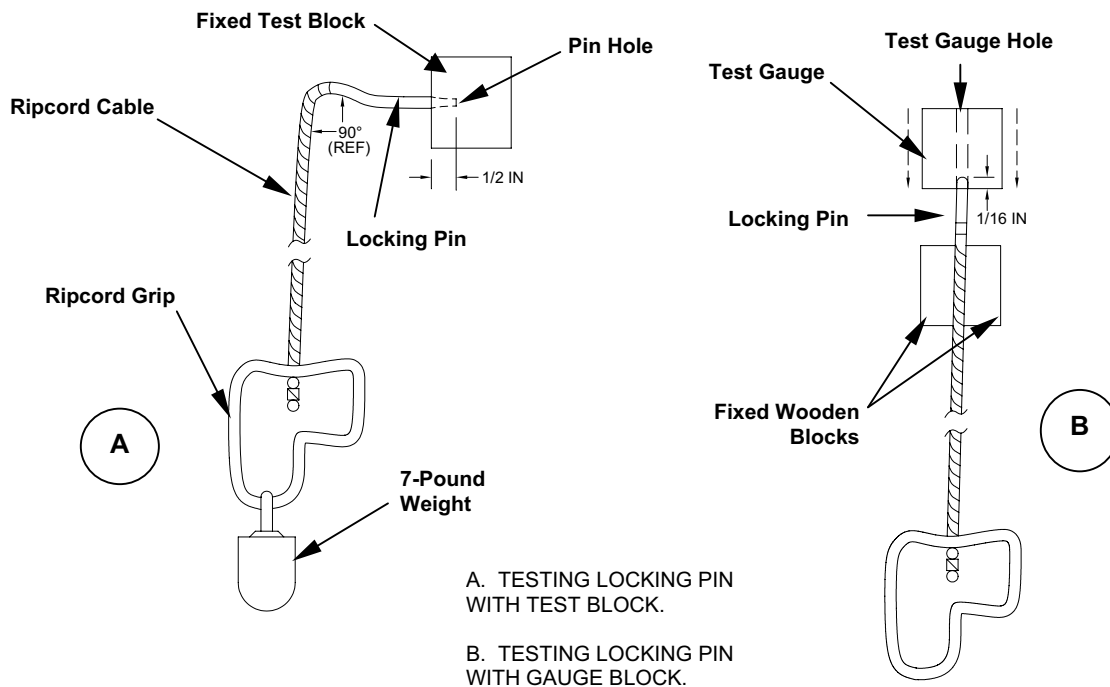

- b. Attach a 7-pound weight to ripcord grip and suspend weight from handle, exercising care to apply the load gradually without impact. The hands or lifting device, as applicable, must be fully removed from the weight.

NOTE

A ripcord-locking pin will withstand a 7-pound load without assuming a permanent set.

- c. Remove weight, rotate locking pin one-quarter turn, and test pin again by reapplying the load as prescribed in step b.
- d. Repeat the procedure in step c. until locking pin has been tested in four positions and rotated one-quarter turn prior to each test.

NOTE

Each locking pin on a ripcord length will be tested under load in four positions.

- e. Remove weight from ripcord grip and remove locking pin from test block.
- f. Visually examine the tested locking pin to ascertain if it was marred, cracked, or distorted during the test under load. If any defects are noted, remove ripcord from service.
- g. Repeat procedure in steps b. through f. for the remaining locking pins on the ripcord length. After testing all locking pins, if there are no visual defects apparent, test each of the locking pins for bends.
- h. Place locking pins in vertical position with pin end facing up and either clamp the pin between two wooden blocks at a point below the shoulder (as shown in B of the illustration on the previous page) or hold between the thumb and index finger of one hand.
- i. Using test gage, manually locate the hole in the block over the end of the secured pin, allowing for a  $\frac{1}{16}$ -inch maximum insertion.
- j. With axis of the gage block hole aligned with axis of the locking pin, release gage block and allow block to fall freely.
- k. When the weight of the gage block fails to cause full penetration of the pin into gage block hole, the pin is excessively bent. Remove ripcord from service.
- l. Repeat the procedures in steps h. through k. for each of the remaining locking pins on the ripcord length.
- m. Position ripcord grip on a fixed hook from a corner nearest weld.

- n. Attach and suspend a 40-pound weight from the opposite corner of grip nearest to the weld. Ensure that total weight is suspended without impact. Hands or lifting device, as applicable, must be fully removed from weight.

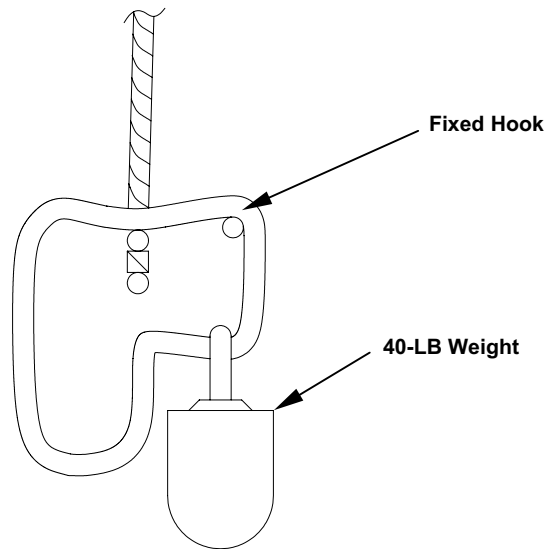

- o. Using suitable illumination, visually inspect welded joint for cracks or breaks. If any cracks or breaks are detected in welding area, remove ripcord from service.
- p. Remove weight from ripcord grip and remove grip from hook.
- q. A ripcord that has been tested according to above and is considered serviceable shall be marked to indicate test accomplishment. Wrap two turns of  $\frac{1}{2}$  inch-wide yellow pressure-sensitive tape around the center of the grip tubing at a point near the weld. However, ensure tape wrapping does not cover the welding joint.

## LAYOUT

1. Perform layout as follows:
  - a. Lay out parachute on a clean dry surface with canopy positioned on its left side. Leading edge (nose) will be to the right when viewed from riser end.
  - b. Stretch lines full length with a helper positioned at riser end to check continuity and to hold lines taut.

- c. Grasp high points of each cell and flip canopy toward trailing edge. Canopy shall lie flat with trailing edge lines on left side when viewed from riser end.

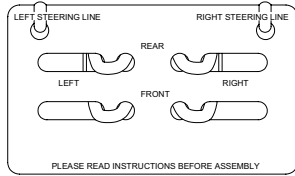

LINE ORGANIZING CARD



- d. Remove any twists, turns, and tangles between suspension line groups.
- e. Starting with lines 8A and 8B, raise to a sufficient height to see if line 8A runs free from canopy through right front slider grommet to outside of right front riser connector link. Line 1A should run free through left front slider grommet to outside of left front riser connector link.

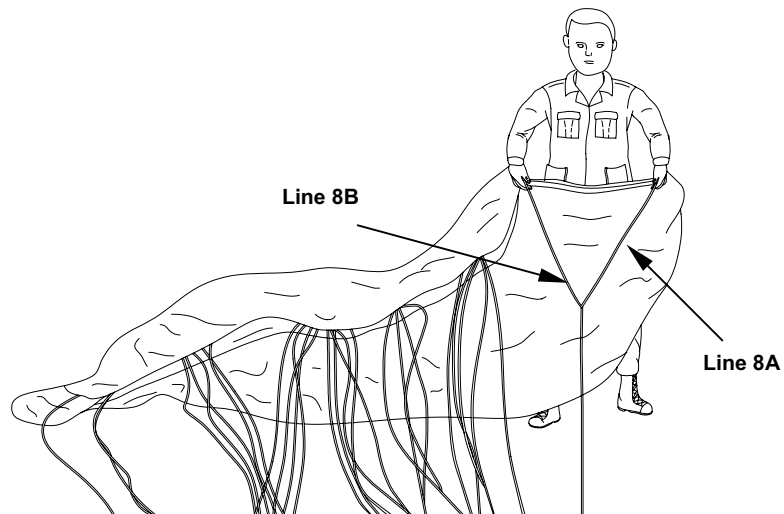

- f. Grasp lines 8C and 8D and raise to a sufficient height to see if line 8C runs free from canopy through right rear slider grommet to outside of right rear riser connector link. Line 1C should run free through left rear slider grommet to outside of left rear riser connector link.

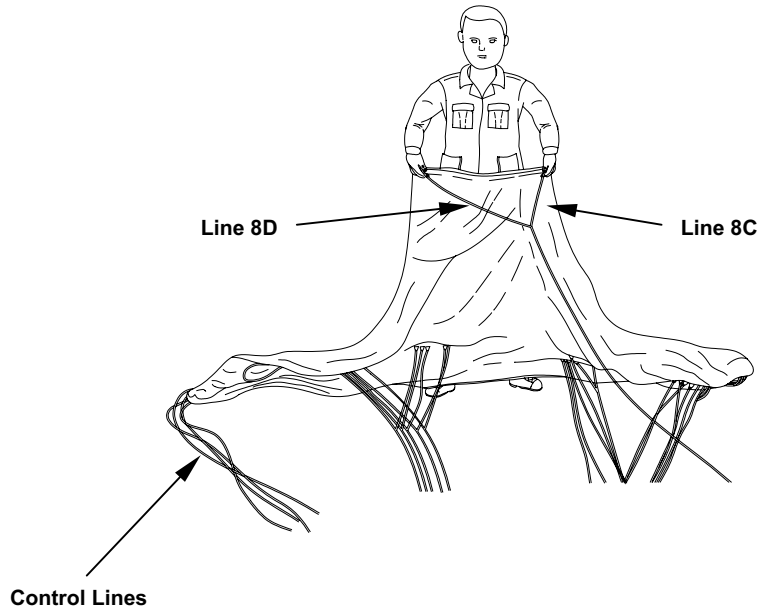

- g. Grasp control lines and raise to a sufficient height to ensure they run free and clear from the tail through the proper slider grommets to the line-organizing card.

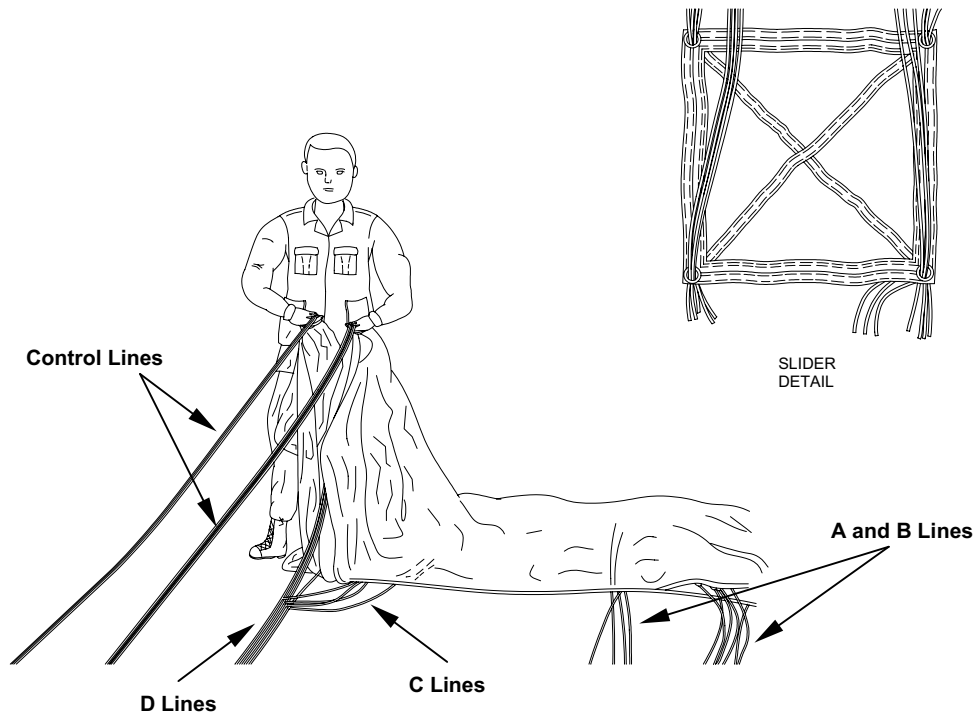

**ATTACHMENT OF CANOPY TO RISERS**

Attach canopy to risers as follows:

1. Lay out container at connector links with risers facing canopy and parachute compartment facing up.
2. Prior to attaching connector links to the risers, if applicable, re-position suspension lines on the short portion of the connector link.

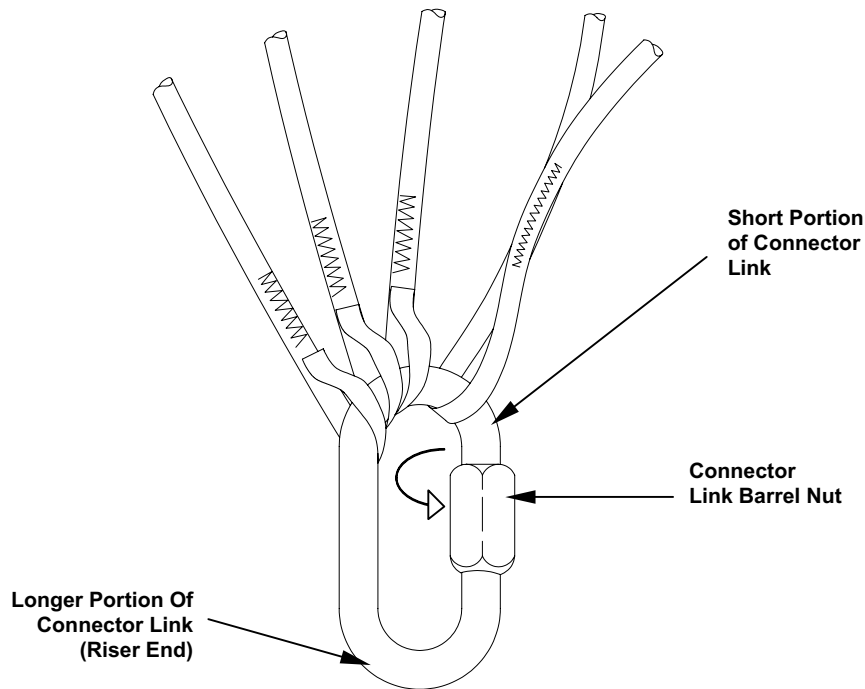
**NOTE**

Connector link barrel nuts must face inboard and tighten upward.

3. Remove connector links and control lines from line organizing card and loosely connect connector links and control lines to proper riser.
4. Perform a suspension line continuity check by tracing each line from canopy through proper slider grommet to proper riser connector link as follows:
  - a. Hang the parachute at every loaded rib, with clamps, by its tail, using a suitable (locally manufactured) suspension device (approximately 16-feet in length).
  - b. Elongate the suspension lines and obtain suspension line group separation.
  - c. Suspend the slider by the two rear grommets.



- d. Secure the risers to a suitable anchor point.

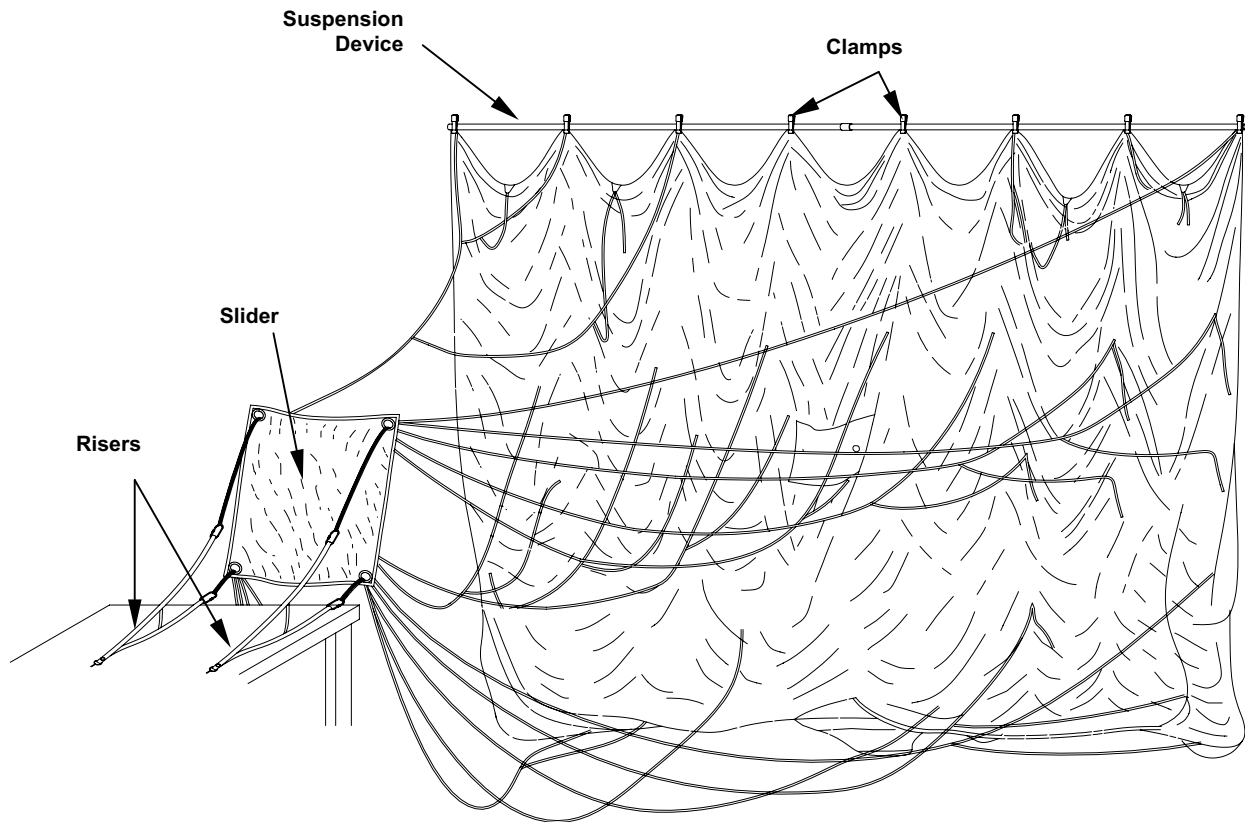

- e. Trace each riser up to the connector link and ensure each barrel nut faces inboard and closes upward toward the canopy.
- f. Check the slider to ensure the reinforcement webbing is facing the canopy and the arrow is facing down.

**NOTE**

During the process of tracing each control line/cascade line, half twists are acceptable.

- g. Check each control line to ensure it is not misrouted by following the base line of the control line from the canopy-attaching loop down to the toggle.
- h. Grasp the base line of the control line at the attaching loop again and using thumb and forefinger, trace the base line down to the 3<sup>rd</sup> finger trap ensuring there are no full twists.

- i. Trace each cascade line attached to the base line ensuring there are no full twists and that each line is attached to the appropriate corresponding attaching loop.

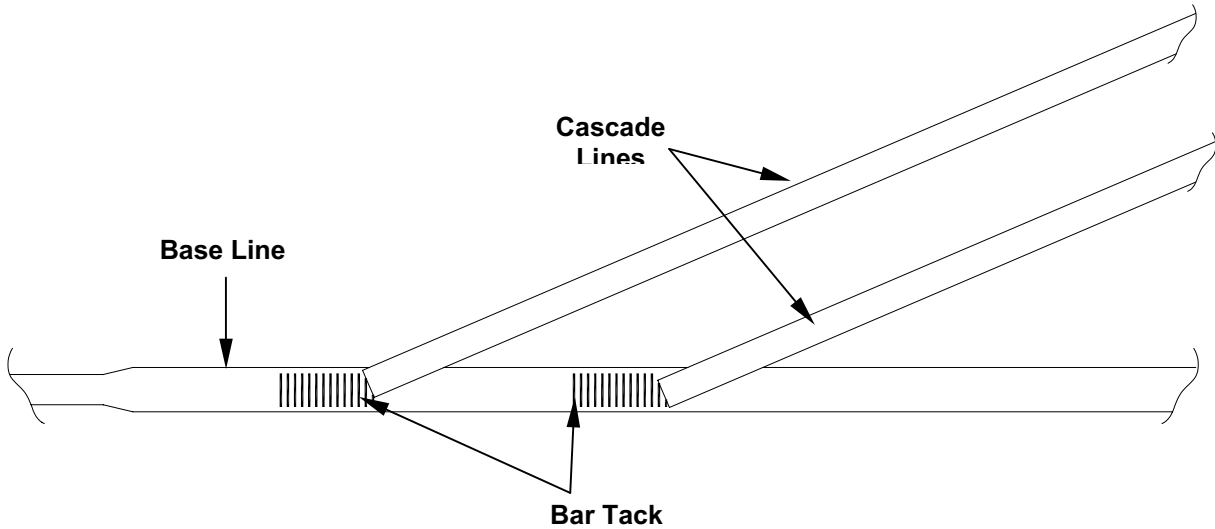

- j. Starting with line 1C, trace the line to the bar tack using the thumb and forefinger and remove all twists. From the bar tack trace line 1D to the canopy-attaching loop then continue tracing line 1C from the bar tack to the canopy-attaching loop.
  - k. Using the procedures from step l., above, trace lines 2C and 2D through 8C and 8D.
  - l. Starting with line 1A, trace the line up to the bar tack using thumb and forefinger and remove all twist. Trace line 1B from the bar tack to the canopy-attaching loop, and then continue tracing line 1A to the canopy-attaching loop.
  - m. Using the procedures in step n., above, trace lines 2A and 2B, 3A and 3B, 6A and 6B, 8A and 8B.
  - n. Lines 4A and 5A are continuous. Trace each line from the connector link to the canopy attaching loops ensuring there are no twists and that line 4A and 5A are attached to the nose of the canopy.
5. Using  $\frac{7}{16}$ -inch open-end wrench, tighten barrel nut on connector links  $\frac{1}{4}$  turn past hand tight.
  6. Hand-tack each riser below the connector link with one turn double, tape lacing and tying, and with an overhand knot.

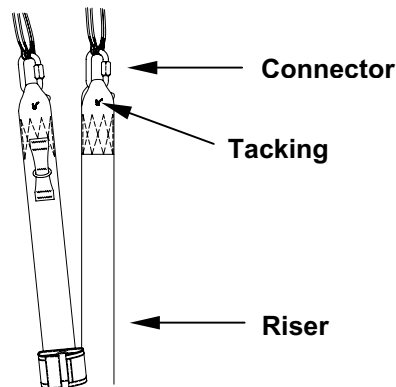

7. Remove parachute from suspension device and place in proper layout.

### APPLICATION OF MARKINGS

Apply markings as follows:

#### NOTE

When a parachute component is placed in service, the month and year of date placed in service shall be marked on it.

1. Canopy. On cell with data block.
2. Pilot chute assembly. Anywhere on fabric area that will be visible after marking.
3. Slider. Anywhere on fabric area that will be visible after marking.
4. Risers. Stencil riser on fabric, in suitable location (near data tag).
5. Allow marking to dry 20 to 30-minutes.

### INSTALLATION OF SAFETY STOW; ELASTIC LOOP IN DEPLOYMENT BAG

Install safety stow elastic loop in deployment bag as follows:

#### CAUTION

Do not tack elastic loop to deployment bag. Safety stow elastic loop must move freely within guide channel.

1. Insert elastic loop in channel. Center loop splice between grommets.
2. Route each loop end through appropriate grommet.

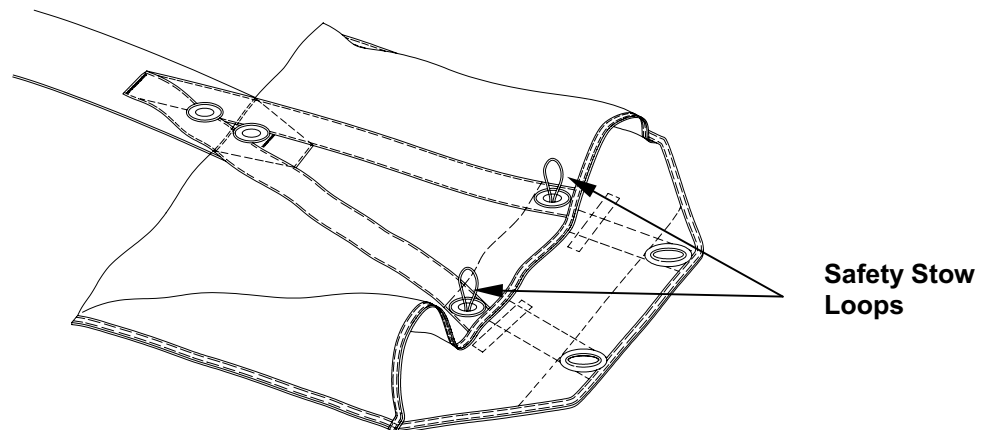

**ATTACHMENT OF CONTROL LINES TO CONTROL TOGGLES**

Attach control lines to control toggles as follows:

1. Pass control line through guide ring on rear riser, and the through ring on control toggle.

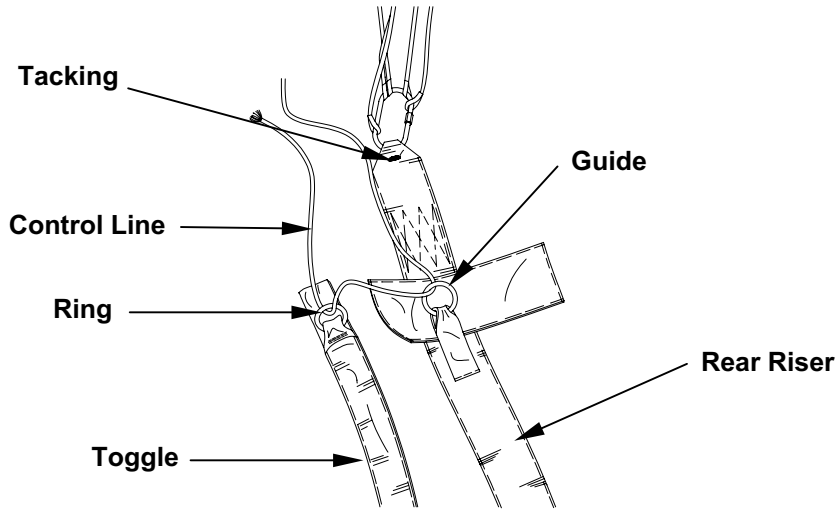

2. Temporarily secure control line to ring with a loose overhand knot against toggle ring.

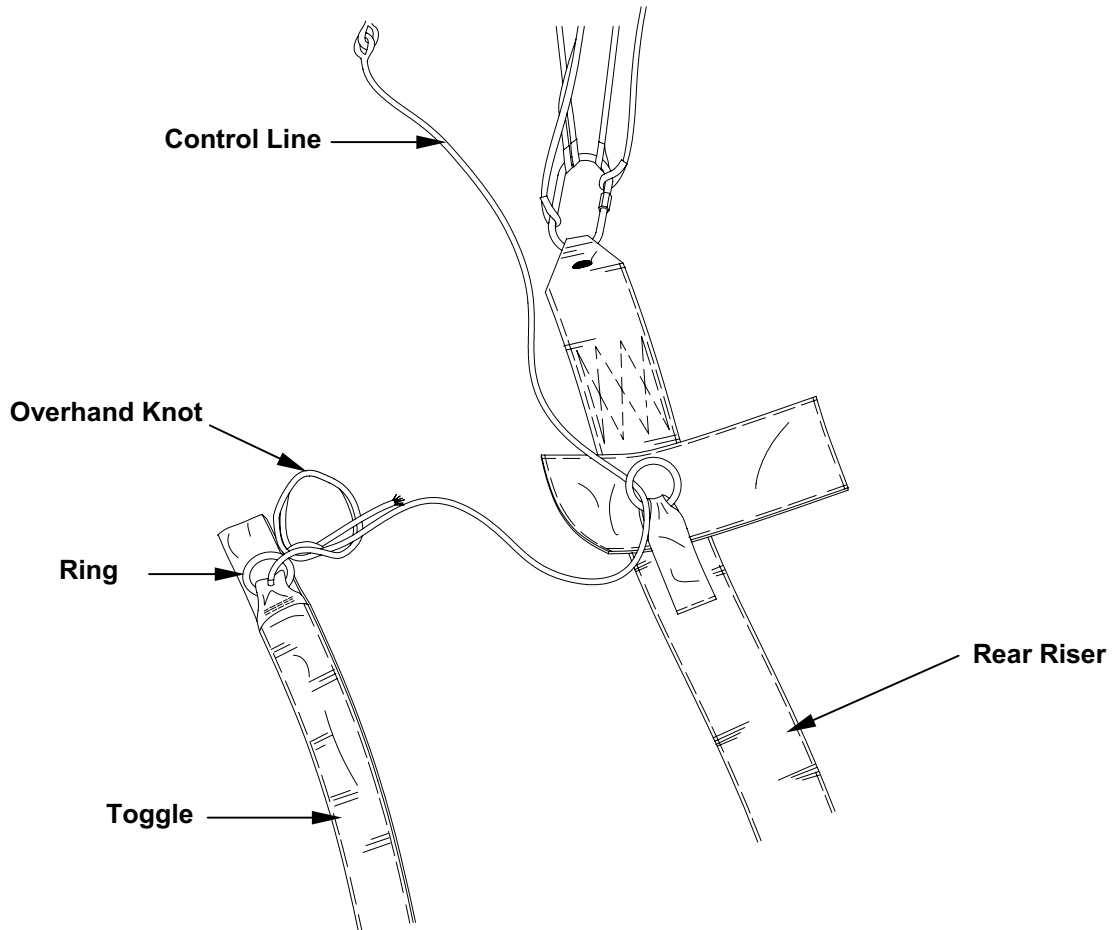

**NOTE**

Final adjustment will be made during the full-flight trim check (WP 0005 00).

3. Perform canopy trim check as follows:
  - a. Using the equipment D-rings, attach the container to a stationary point, ensuring equal tension, with the harness down and container facing up.
  - b. Obtain suspension line group separation and place canopy with the nose down and the tail facing up.
  - c. Pull control lines down until finger-trapped loops are below control line guide rings.

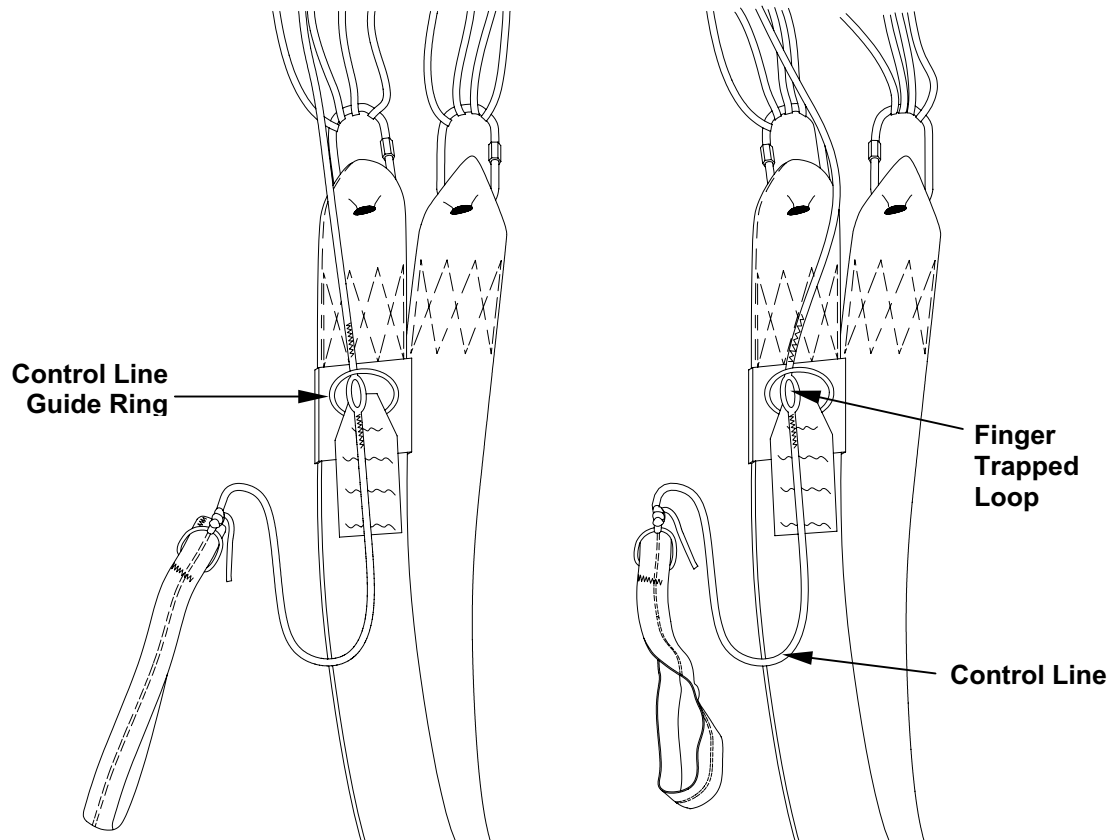

- d. Move right finger-trapped loop and riser strap to the left riser strap. Insert toggle thong through both finger-trapped loops.

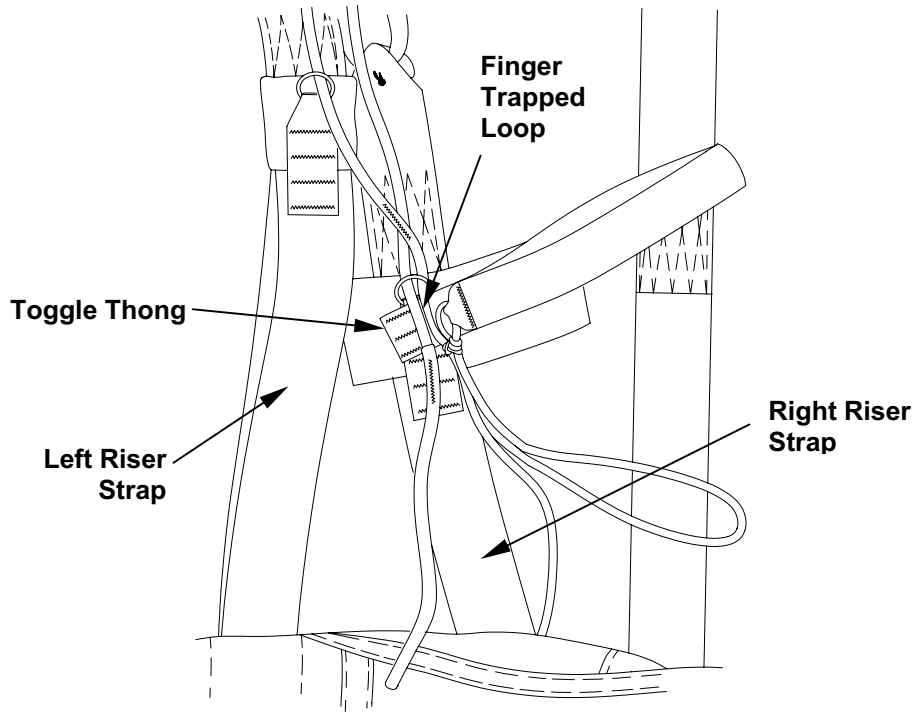

- e. With the toggles inserted in the finger trap loops, locate lines 1A and 8A.

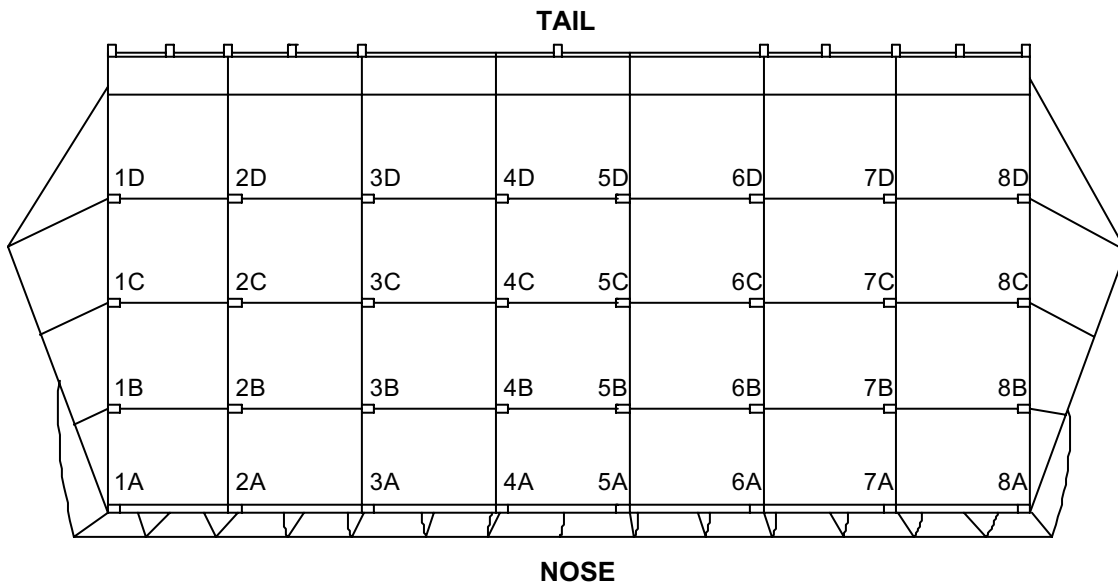

**NOTE**

Pull both lines evenly before looking at the ruler to ensure an accurate measurement can be obtained.

- f. Grasp canopy fabric near line 1A attaching loop. Moving to center of canopy, pull line 1A and the control line on the right riser and compare lengths to ensure control line is 15-inches ( $\pm 1$ -inch) longer than line 1A.

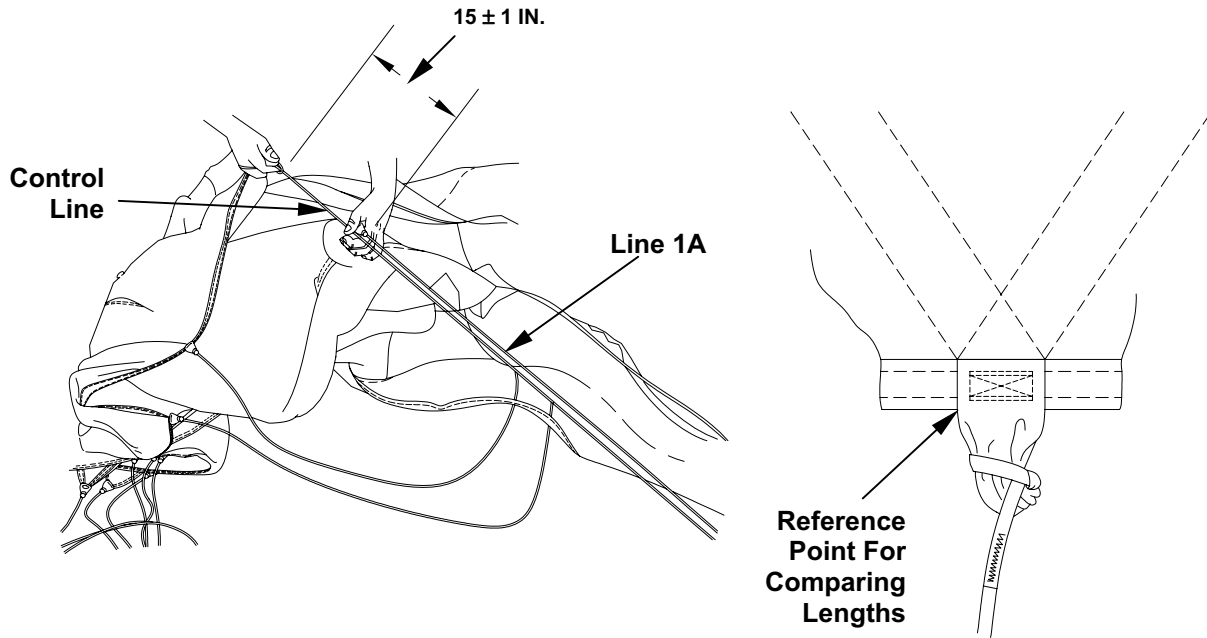

- g. Grasp the base line of the right control line and compare the control line cascade lines to the control line base line and insure they are even ( $\pm 1/2$ -inch).

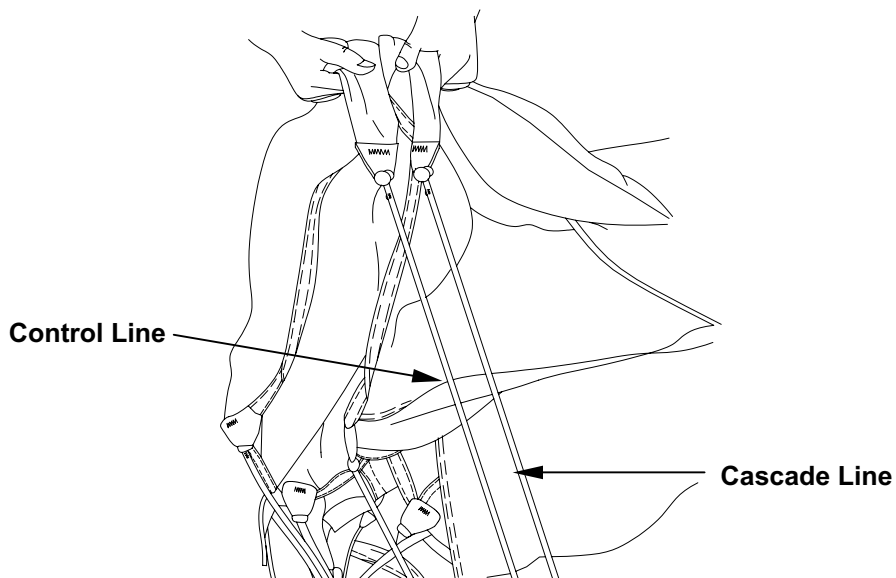

- h. Grasp canopy fabric near line 8A attaching loop. Moving to center of canopy, pull line 8A and the control line on the left rear riser and compare lengths to ensure control line is 15-inches ( $\pm 1$ -inch) longer than line 8A.

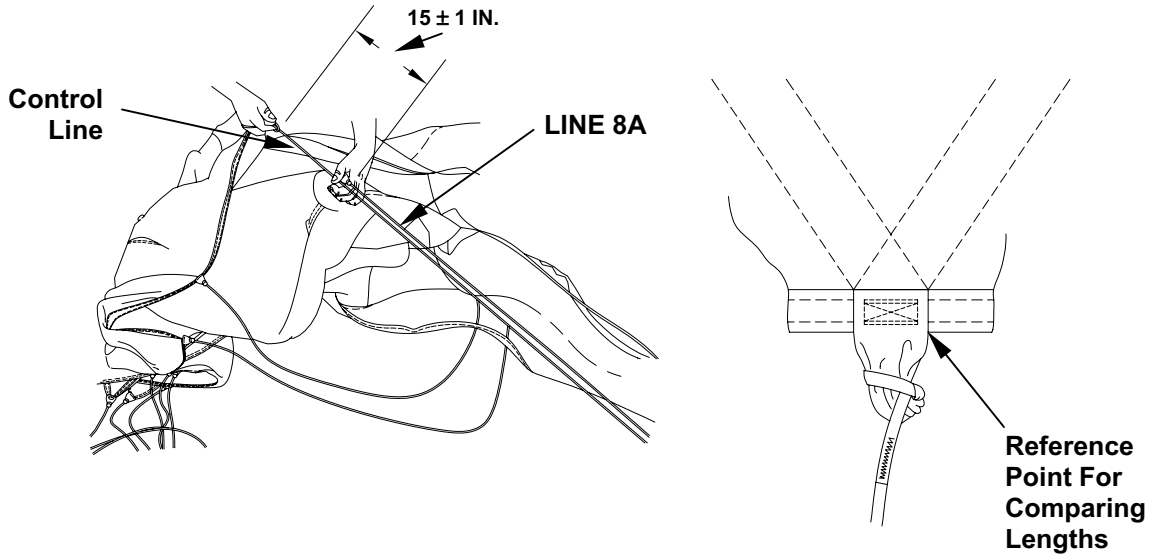

- i. Grasp the base line of the left control line and compare the control line cascade lines to the control line baseline and ensure they are even ( $\pm 1/2$ -inch).

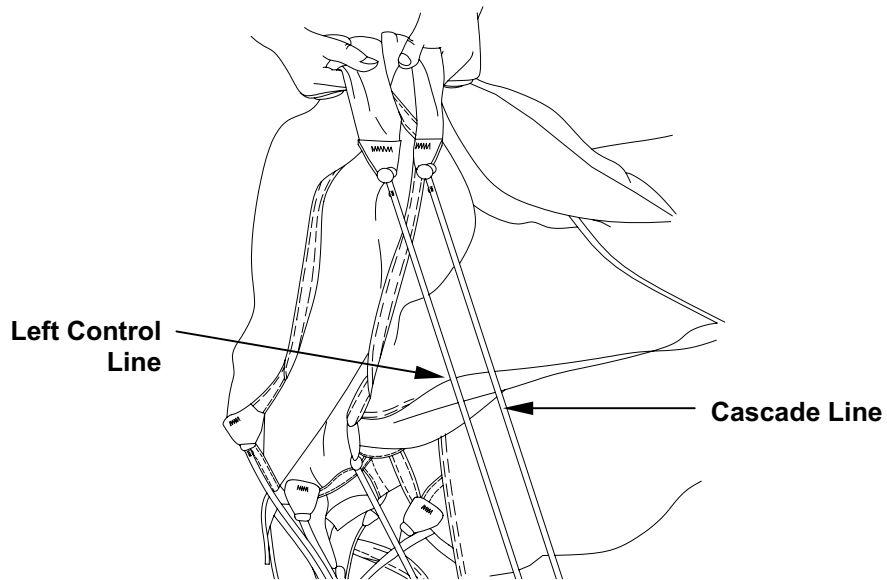



- j. Move to the trailing edge of the canopy (tail). Grasp canopy fabric near both main control line attachment loops. Pull control lines and compare to ensure lengths are equal within 1/2-inch.

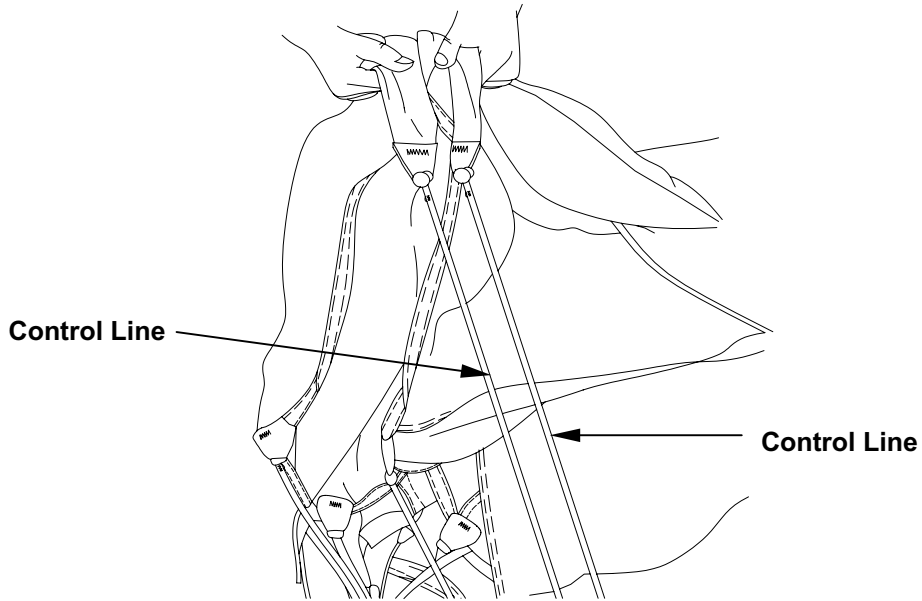

- k. Remove toggles from finger trap loop.
- l. Move to leading edge of canopy and ensure connector links are held even with one another.
- m. Grasp canopy fabric near lines 1A and 1B attachment points. Moving to center of canopy, stretch and compare lengths. Line 1B should be 3-inches ( $\pm 1$ -inch) longer than line 1A.

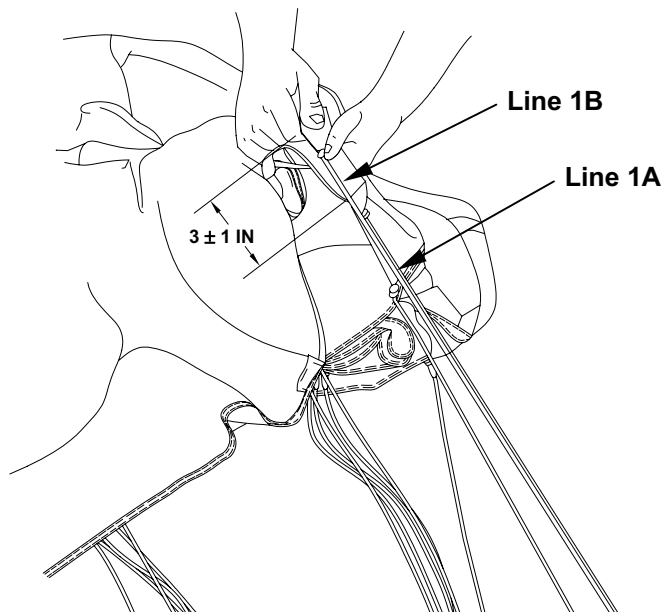

- n. Grasp canopy fabric near lines 1B and 1C attachment points. Moving to center of canopy, stretch and compare lengths. Line 1C should be 9-inches ( $\pm 1$ -inch) longer than line 1B.

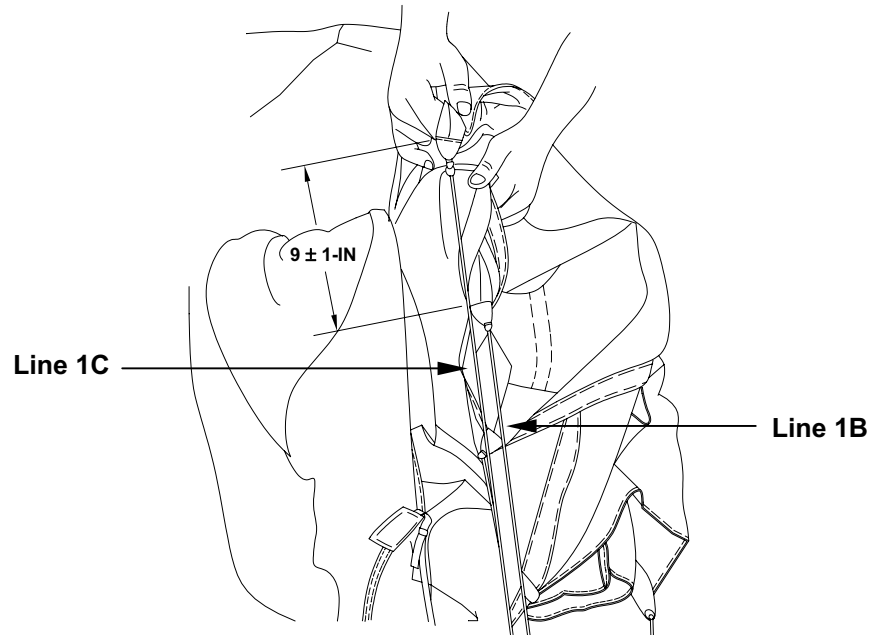

- o. Grasp canopy fabric near lines 1C and 1D attachment points. Moving to center of canopy, stretch and compare lengths. Line 1D should be 12-inches ( $\pm 1$ -inch) longer than line 1C.

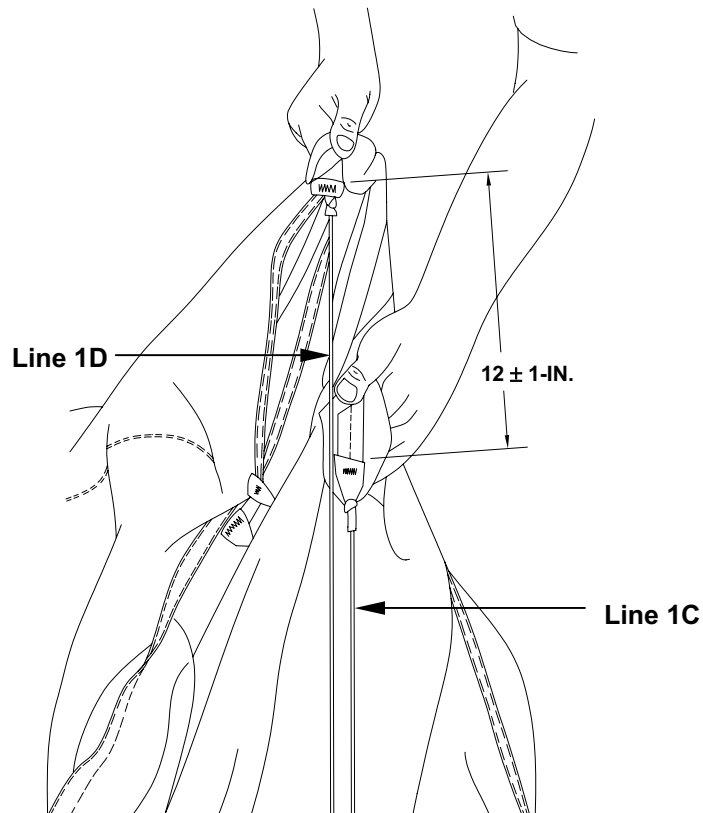

- p. Move to the trailing edge of the canopy and ensure connector links are held even with one another.
- q. Locate lines 1D and 8D.

**NOTE**

Pull both lines evenly before looking at the ruler to ensure an accurate measurement can be obtained. Adjust knot at the toggle to obtain correct length.

- r. Grasp canopy fabric near line 1D attaching loop. Moving to center of canopy, pull line 1D and the control line on the right riser and compare lengths to ensure control line is 15-inches ( $\pm 1$ -inch) longer than line 1D.

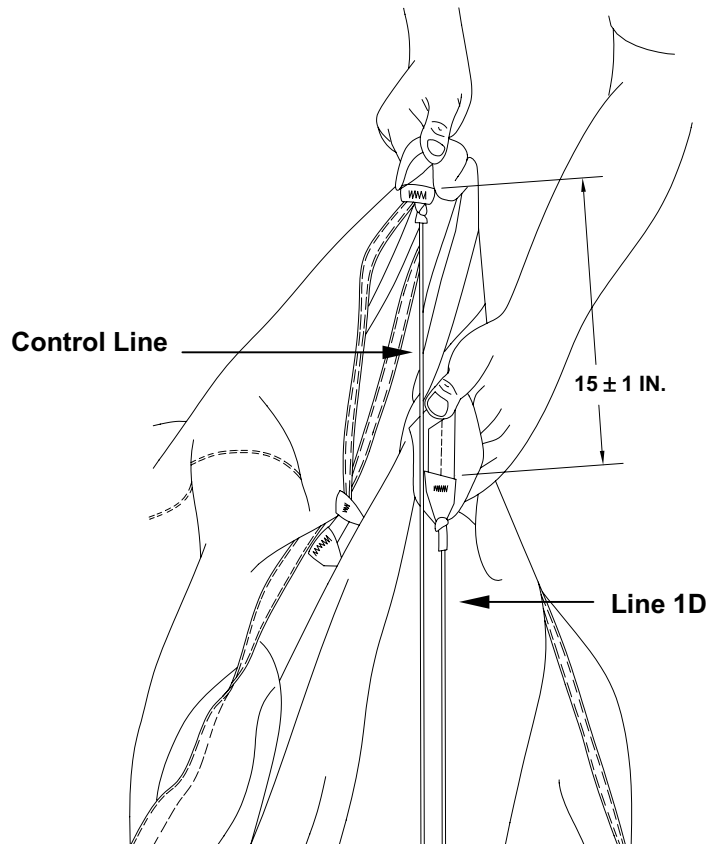

**NOTE**

Pull both lines evenly before looking at the ruler to ensure an accurate measurement can be obtained. Adjust knot at the toggle to obtain correct length.

- s. Grasp canopy fabric near line 8D attaching loop. Moving to center of canopy, pull line 8D and the control line on the left riser and compare lengths to ensure control line is 15-inches ( $\pm$  1-inch) longer than line 8D.

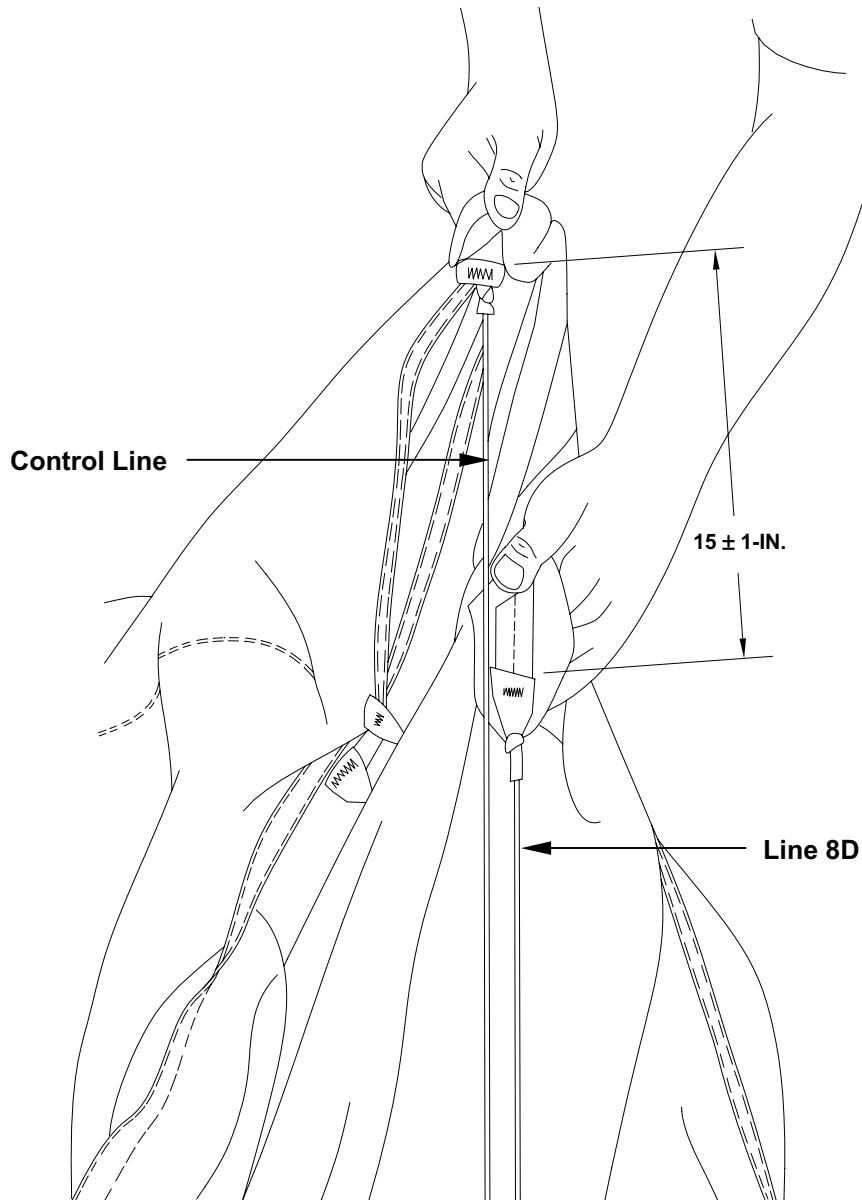

- t. Move to the trailing edge of the canopy. Grasp canopy fabric near both main control-attaching loops. Pull control lines and compare to ensure lengths are equal ( $\pm \frac{1}{2}$ -inch).

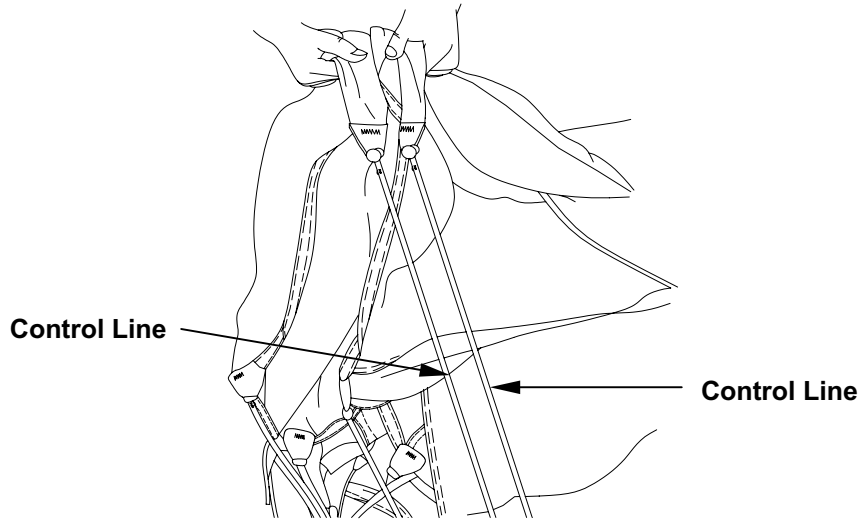

**NOTE**

Ensure the knot is drawn tight against the toggle ring.

- u. Permanently secure control line knot formed below. Trim the running end to the length of the toggle.

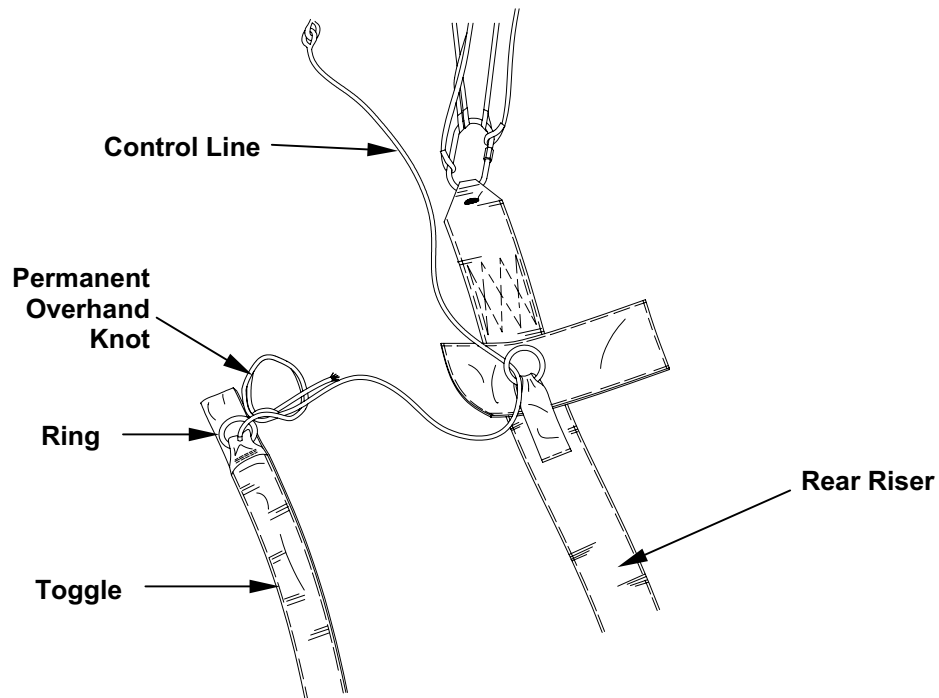

4. Perform spanwise line check as follows:

- a. Lay out parachute on a clean dry surface with canopy positioned on its left side. Leading edge (nose) will be on right when viewed from riser end. Stretch lines full length with a helper positioned at riser end to check continuity and to hold lines taut.
- b. Grasp high points of each cell and flip canopy toward trailing edge. Canopy shall lie flat with trailing edge lines on left side when viewed from riser end.

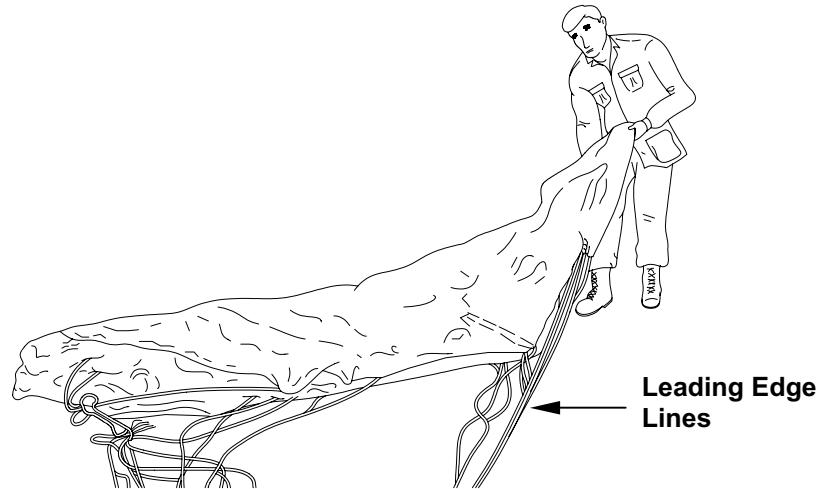

- c. Beginning with line 1A, compare each line in the A group. The maximum allowable difference between that line and any other line is 1/2-inch.
- d. Repeat step c., above, for B, C, and D line groups.

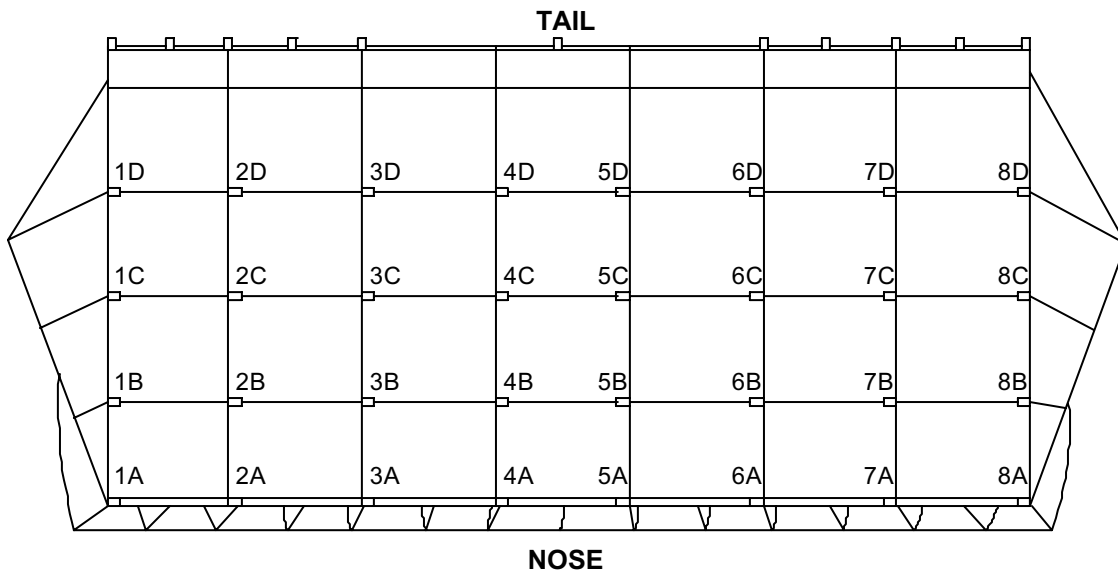

END OF WORK PACKAGE

**MC-4 RAM AIR FREE-FALL PERSONNEL PARACHUTE SYSTEM  
ASSEMBLY – MAIN PARACHUTE**

**THIS TASK COVERS:**

- Ripcord Test
- Layout
- Attachment of Canopy to Risers
- Application of Markings
- Attachment of Control Lines to Control Toggles
- Attachment of Pilot Chute, Bridle Line, and Deployment Bag
- Attachment of Risers to Harness/Container
- Canopy Trim Check
- Spanwise Line Check

**INITIAL SETUP:**

**Personnel Required**

- 92R(10) Parachute Rigger
- 92R(20) Parachute Rigger

**Tools**

- Brush, Stenciling (Item 5, WP 0063 00)
- Inspection Kit, Ripcord (Item 21, WP 0063 00)
- Machine, Stencil Cutting (Item 26, WP 0063 00)
- Needle, Tacking (Item 29, WP 0063 00)
- Tape Measure (Item 42, WP 0063 00)
- Wrench, <sup>7</sup>/<sub>16</sub>-IN., Open-End (Item 45, WP 0063 00)

**Materials/Parts**

- Ink, Marking, Parachute (Item 25/26, WP 0076 00)
- Stencil Board, Oiled (Item 31, WP 0076 00)
- Tape, Lacing and Tying (Item 33, WP 0076 00)
- Tape, Pressure-Sensitive, Yellow, 1/2-IN. Wide, (Item 38, WP 0076 00)

**Equipment Condition**

Stretch canopy and suspension lines full length in packing area.

**RIPCORD GRIP TEST**

1. Perform a ripcord test as follows:
  - a. Insert 1/2-inch of locking pin end into hole of fixed ripcord locking pin test block (as shown in A below). Ensure the test block is firmly secured in the fixed position.

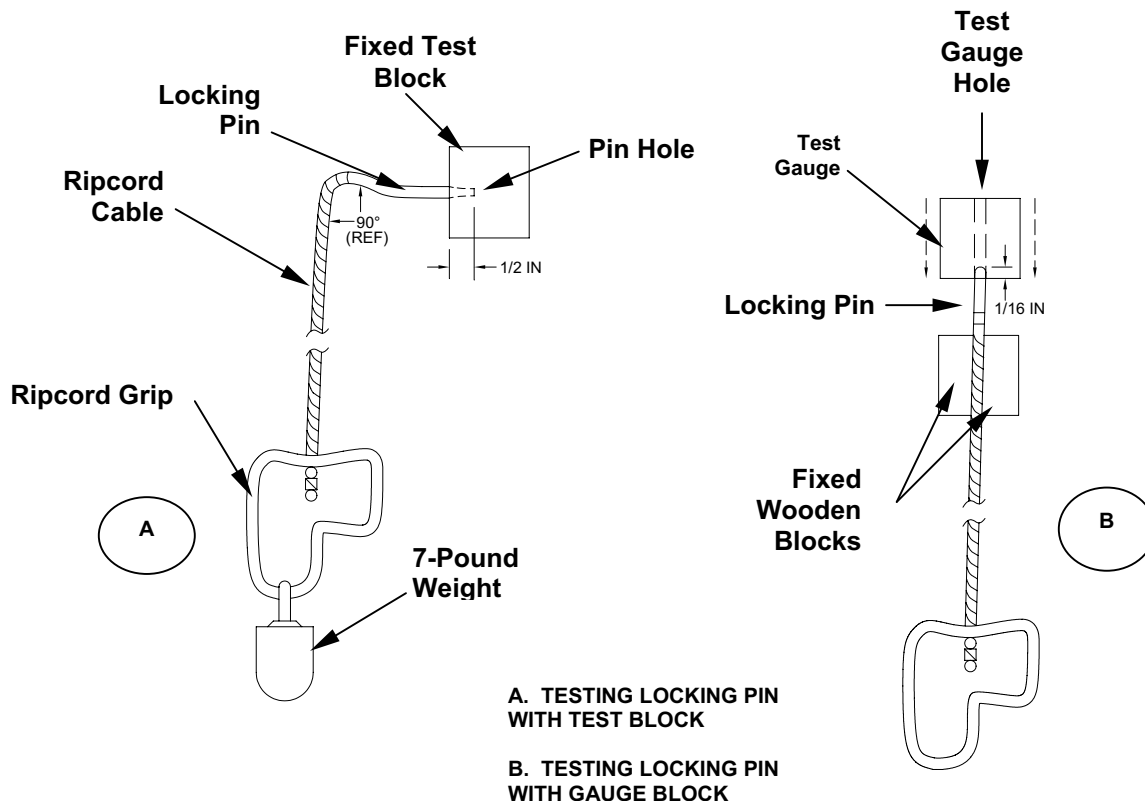

- b. Attach a 7-pound weight to ripcord grip handle and suspend weight from handle, exercising care to apply load gradually without impact. Hands or lifting device, as applicable, must be fully removed from weight.

NOTE

The ripcord-locking pin will withstand a 7-pound load without assuming a permanent set.

- c. Remove weight, rotate locking pin one-quarter turn, and test pin again by reapplying the load as prescribed in step b.
- d. Repeat procedure in step c. until locking pin has been tested in four positions and rotated one-quarter turn prior to each test.

NOTE

Each locking pin on a ripcord length will be tested under load in four positions.

- e. Remove weight from ripcord grip and remove locking pin from test block.
- f. Visually examine tested locking pin to ascertain if it was marred, cracked, or distorted during the test under load. If any defects are noted, remove ripcord from service.
- g. Repeat procedure in steps b. through f. for the remaining locking pins on the ripcord length. After testing all locking pins, if there are no visual defects apparent, test each of the locking pins for bends.
- h. Place locking pin in vertical position with pin end facing up and either clamp the pin between two wooden blocks at a point below the pin shoulder (as shown in B of the illustration on the previous page) or hold between thumb and index finger of one hand.
- i. Using test gage, manually locate hole in the block over the end of the secured pin, allowing for  $\frac{1}{16}$ -inch maximum insertion.
- j. With axis of gage, block hole aligned with axis of locking pin, then release gage block and allow block to fall freely.
- k. When weight of gage block fails to cause full penetration of the pin into the gage block hole, the pin is excessively bent. Remove ripcord from service.
- l. Repeat the procedures in steps h. through k. for each of the remaining locking pins on the ripcord length.
- m. Position ripcord grip on a fixed hook from a corner nearest the weld.



- n. Attach and suspend a 40-pound weight from opposite corner of grip nearest the weld. Ensure that total weight is suspended without impact. Hands or lifting device, as applicable, must be fully removed from weight.

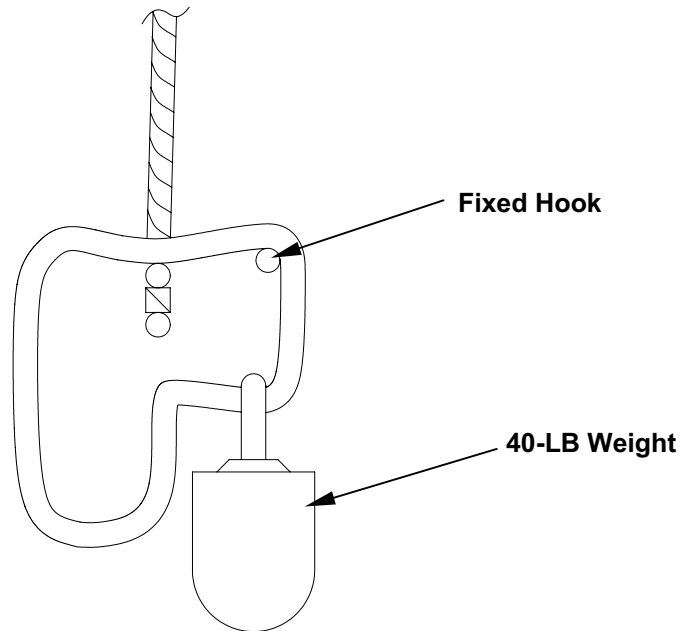

- o. Using suitable illumination, visually inspect welded joint for cracks or breaks. If any cracks or breaks are detected in the welded area, remove ripcord from service.
- p. Remove weight from ripcord grip and remove grip from hook.
- q. A ripcord that has been tested according to above and is considered serviceable will be marked to indicate test accomplishment. Wrap two turns of  $\frac{1}{2}$ -inch-wide yellow pressure sensitive tape around the center of the grip tubing at a point near the weld. However, ensure the tape wrapping does not cover the welding joint.

## LAYOUT

1. Perform layout as follows:
  - a. Lay out parachute on a clean dry surface with canopy positioned on its left side. Leading edge (nose) will be on right when viewed from riser end. Stretch lines full length with a helper positioned at riser end to check continuity and to hold lines taut.

- b. Grasp high points of each cell and flip canopy toward trailing edge. Canopy shall lie flat with trailing edge lines on left side when viewed from riser end.

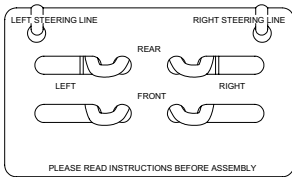

LINE ORGANIZING CARD

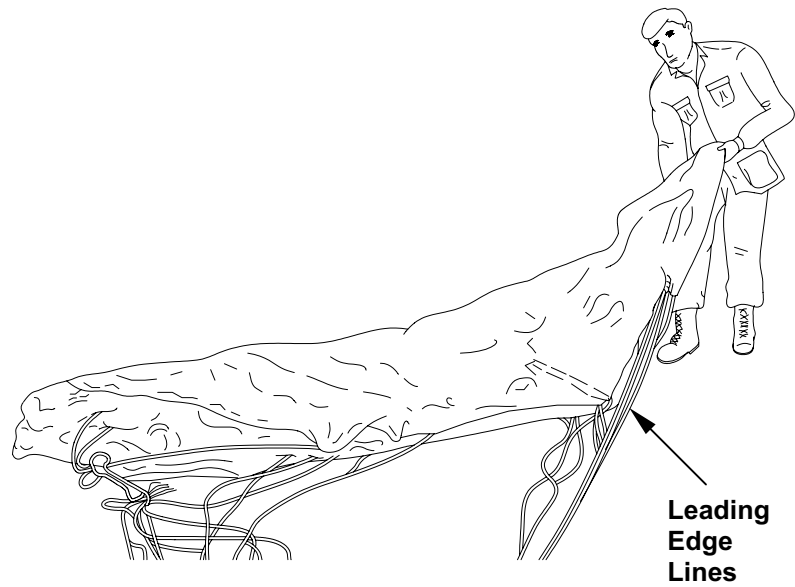

- c. Remove any twists, turns, and tangles between suspension line groups.
- d. Starting with line 8A and 8B, raise to a sufficient height to see if line 8A runs free from canopy through right front slider grommet to outside of right front riser connector link. Line 1A should run free through left front slider grommet to outside of left front riser connector link.

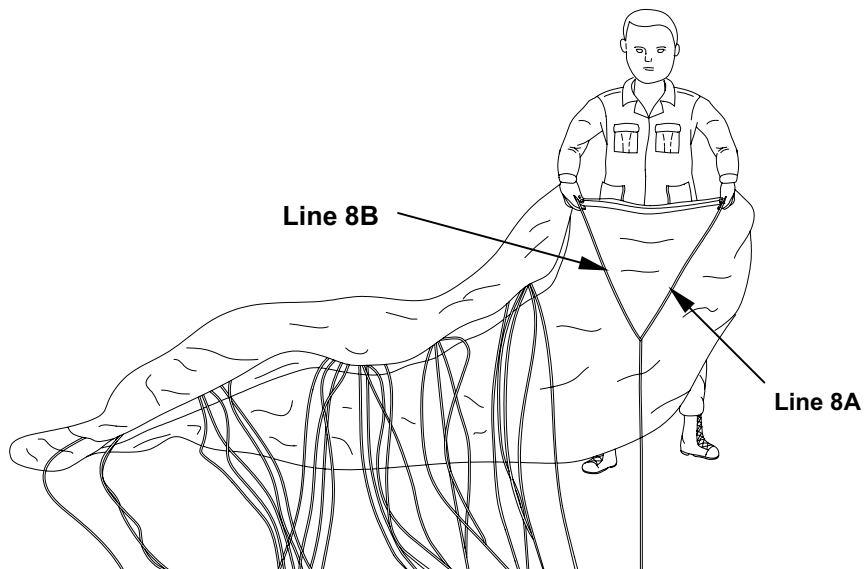

- e. Grasp lines 8C and 8D and raise to a sufficient height to see if line 8C runs free from canopy through right rear slider grommet to outside of right rear riser connector link. Line 1C should run free through left rear slider grommet to outside of left rear riser connector link.

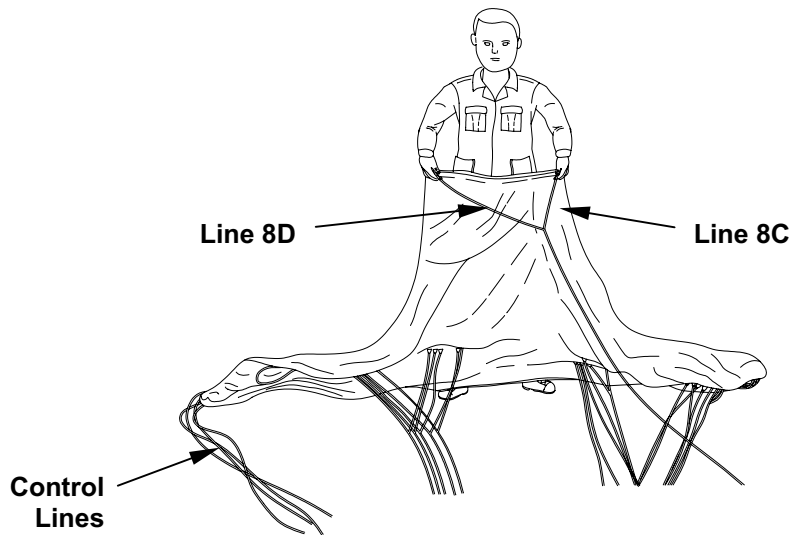

- f. Grasp control line and raise to a sufficient height to ensure they run free and clear from the tail through the proper slider grommets to the line-organizing card.

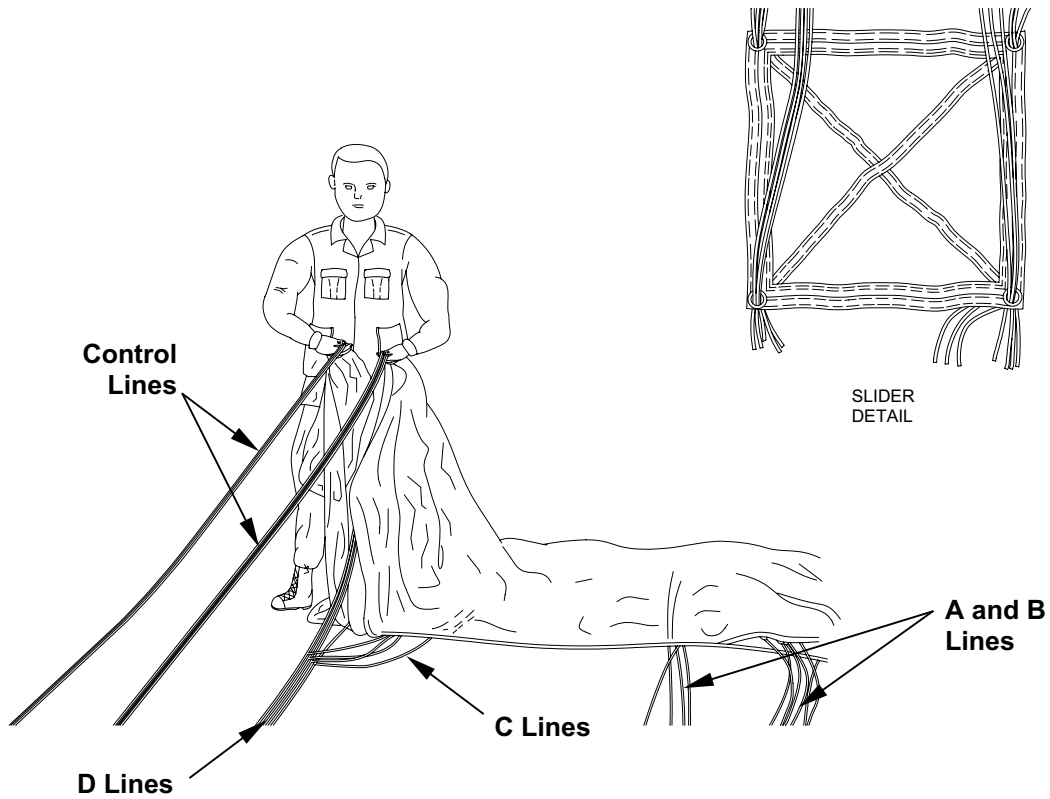

**ATTACHMENT OF RISERS TO HARNESS/CONTAINER**

Attach risers to harness/container as follows:

**CAUTION**

Ensure Clearslip #2™ silicone lubricant does not come in contact with any textile surface of the MC-4 RAPPs.

1. Insert main ripcord cable through main ripcord housing. Insert main ripcord grip into ripcord grip pocket. Apply a small amount of Clearslip #2™ silicone lubricant to a clean dry rag and wipe each single point release cable several times. Allow a few moments for evaporation. Insert single point release cable through cable housings. Mate hook tape on grip with pile tape on harness. Attach reserve static line to container with reserve static line pull ring facing top of container. Pass reserve ripcord cable through reserve static line pull ring and then through reserve static line guide ring.

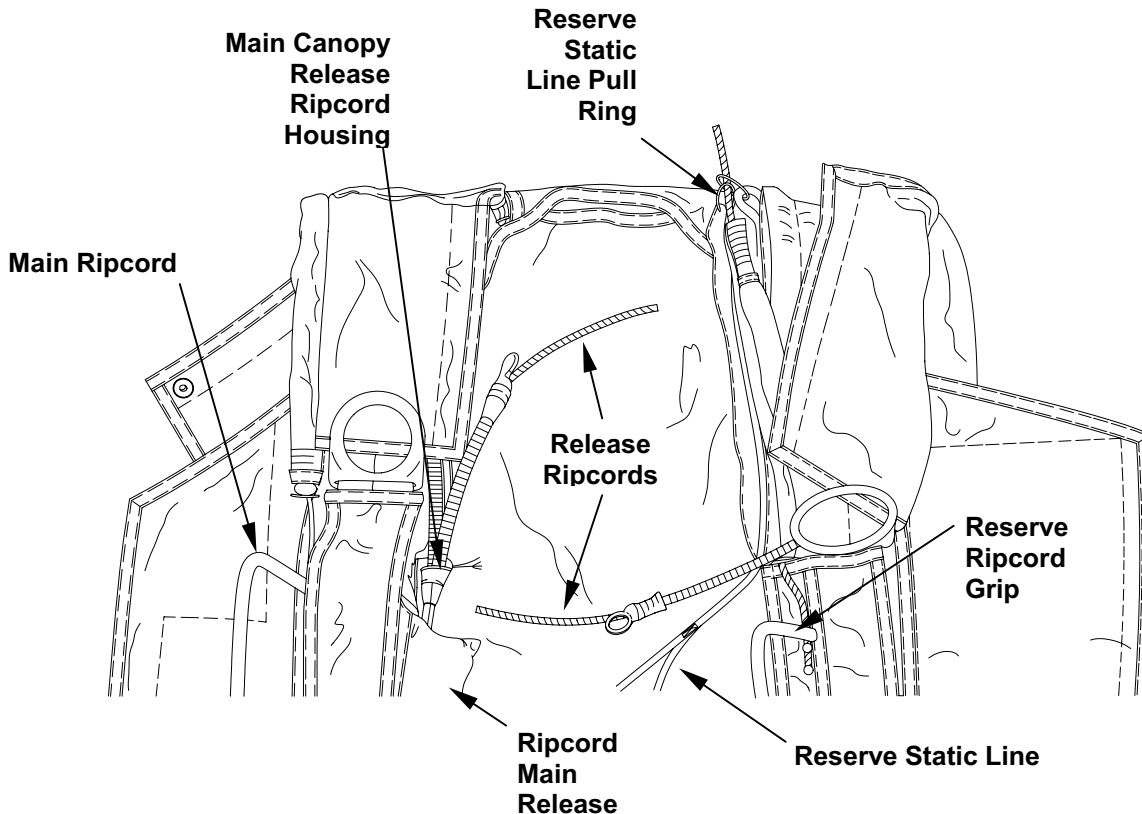

2. Position right riser on harness above main ripcord and pass large ring on riser through base ring of three ring release.

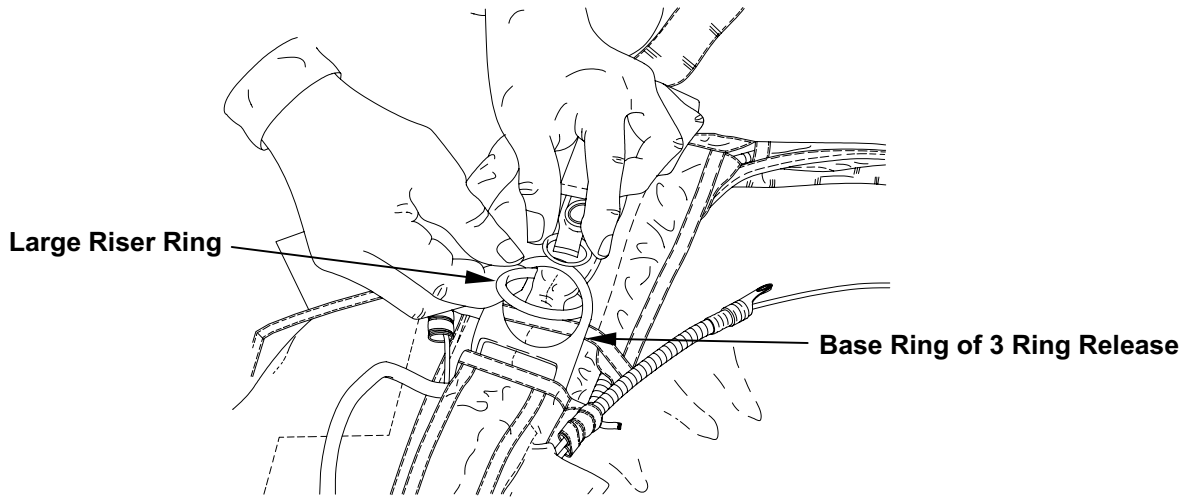

3. Pass small riser ring through large riser ring. Position small riser ring over riser grommet.

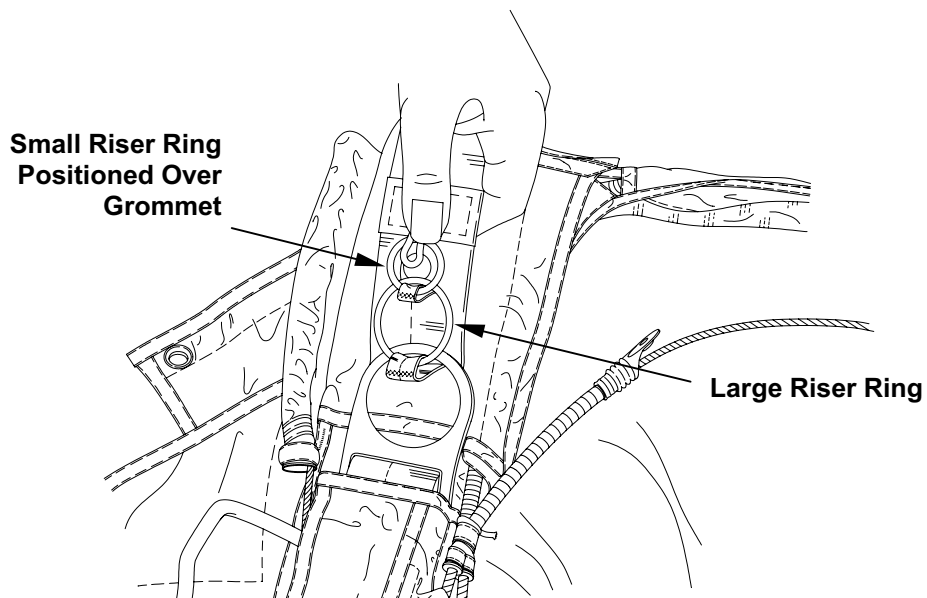

4. Pass locking loop over small riser ring and down through riser grommet. Ensure riser locking loop is not twisted. Insert locking loop through eye on end of cable housing.

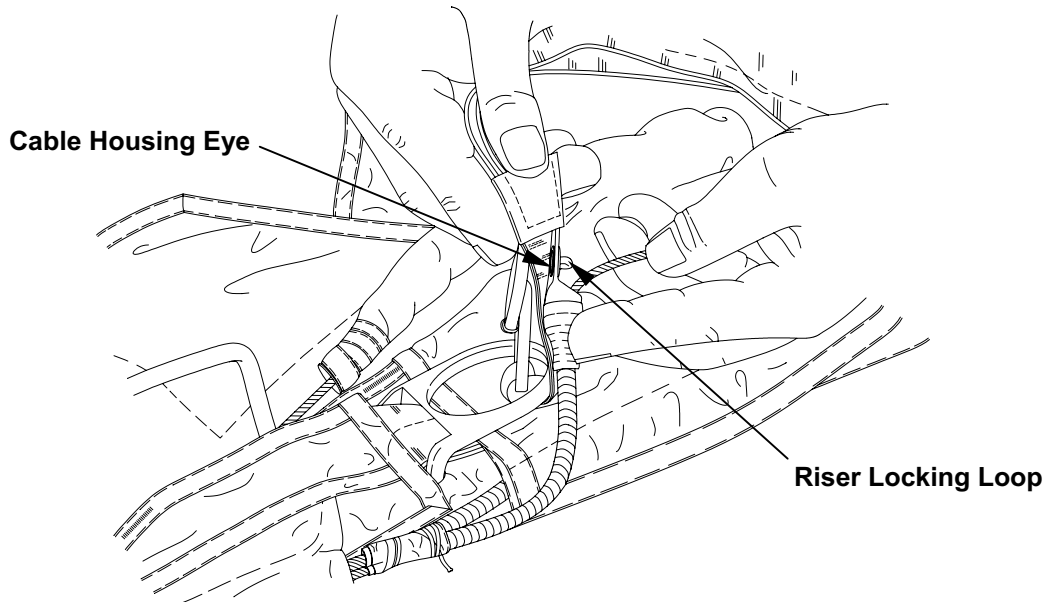

**NOTE**

Ensure riser locking loop is not twisted.

5. Pass main canopy release cable through locking loop and insert main canopy release cable in riser stowage flute.

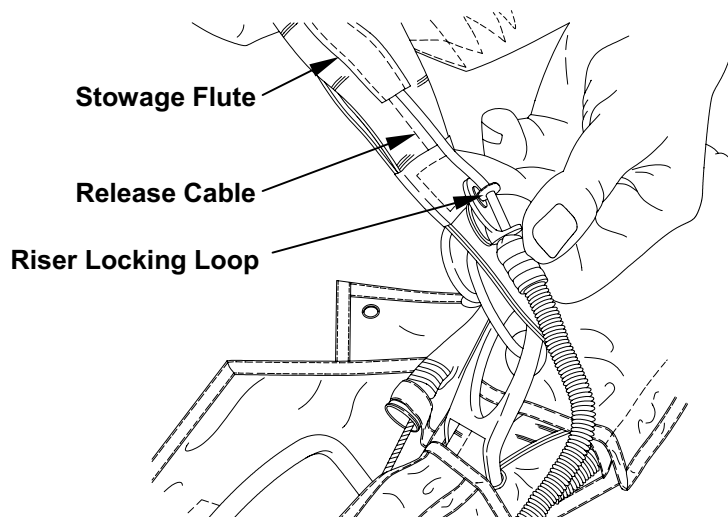

6. Attach left riser to harness in same manner as in step 2. through 5.
7. Connect reserve static line ring to reserve static line release shackle.

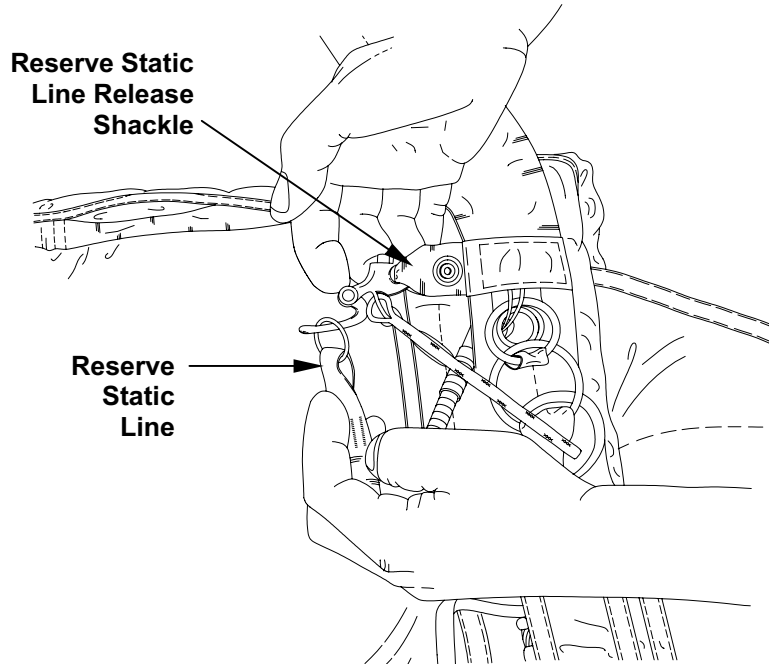

8. Mate and close snap on reserve static line release lanyard to riser snap.

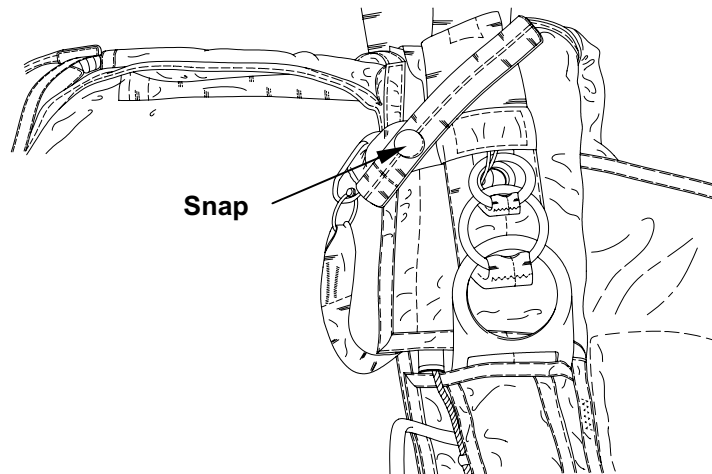

**ATTACHMENT OF CANOPY TO RISERS**

Attach canopy to risers as follows:

1. Position risers at connector links.
2. Prior to attaching connector links to the risers, if applicable, re-position suspension lines on the short portion of the connector link.

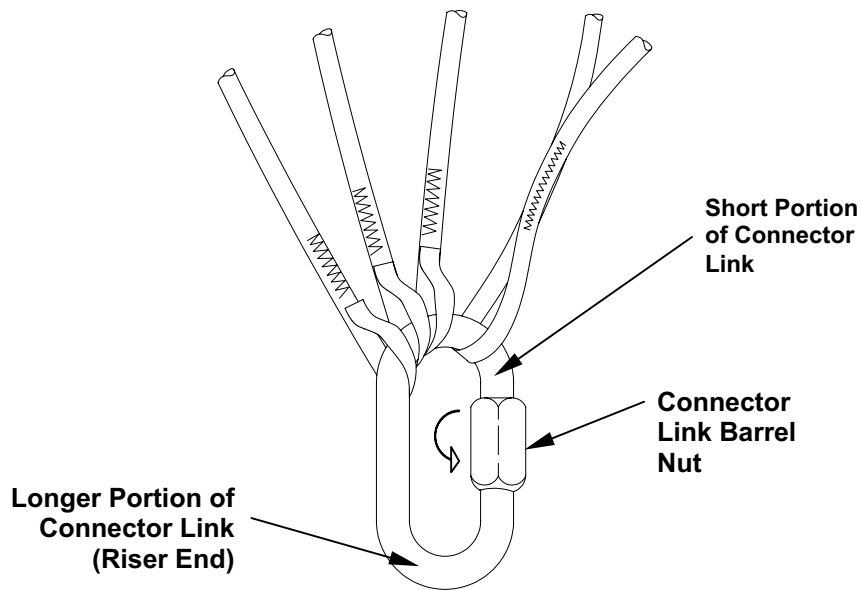
**NOTE**

Connector link barrel nuts must face inboard and tighten upward.

3. Remove connector links and control lines from line organizing card and loosely connect connector links and control lines to proper riser.
4. Perform a suspension line continuity check by tracing each line from canopy through proper slider grommet to proper riser connector link as follows:
  - a. Hang the parachute at every loaded rib, with clamps, by its tail, using a suitable (locally manufactured) hanging device (approximately 16-feet in length).
  - b. Elongate the suspension lines and obtain suspension line group separation.
  - c. Suspend the slider by the two rear grommets.



- d. Secure the risers to a suitable anchor point.

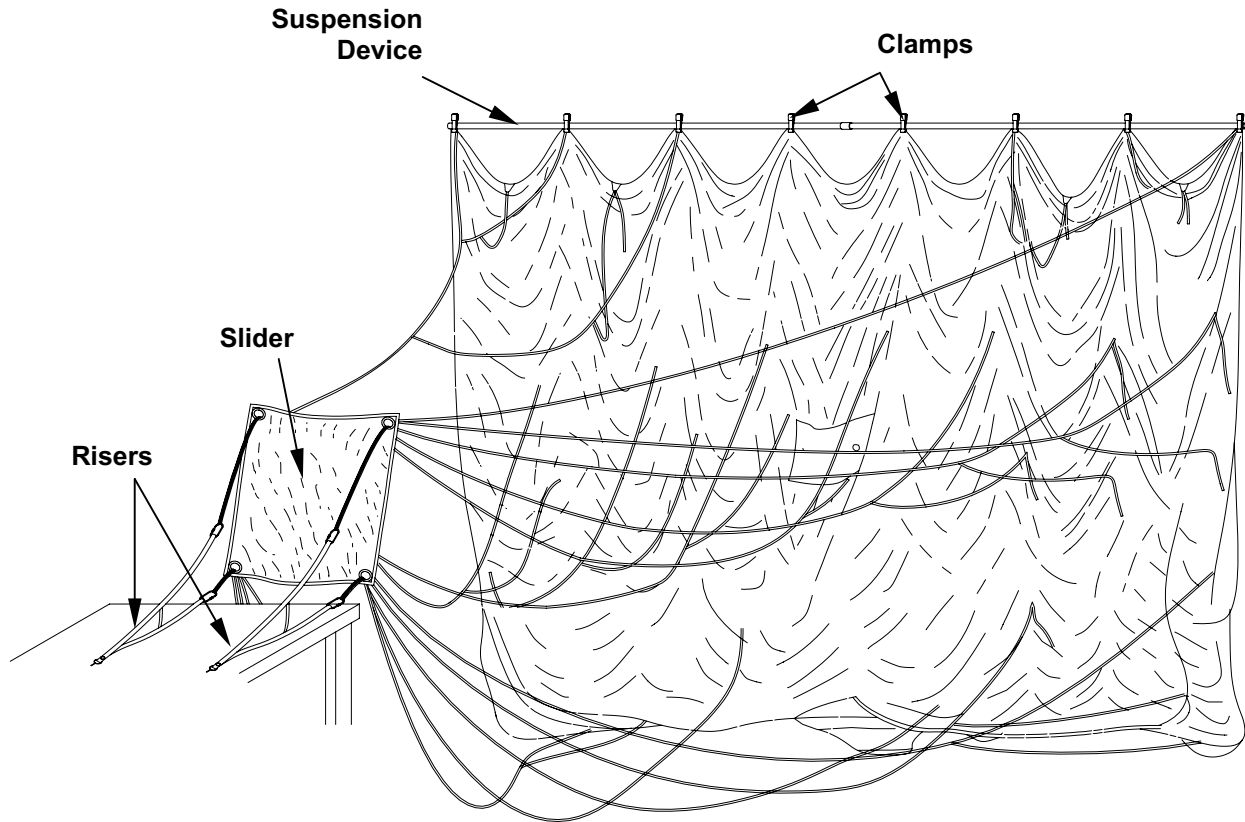

- e. Starting from the risers (from rigger view), check to ensure the right and left risers are attached to the correct side.
- f. Check each riser to ensure that the three-ring assemble is facing down.
- g. Trace each riser up to the connector links and ensure each barrel nut faces inboard and closes upward toward the canopy.
- h. Check the slider to ensure that the reinforcement webbing is facing the canopy and the arrow is facing down.

**NOTE**

During the process of tracing each control line/cascade line, half twists are acceptable.

- i. Check each control line to ensure that it is not misrouted by following the base line of the control line from the canopy-attaching loop down to the toggle.

- j. Grasp the base line of the control lines at the attaching loop again and using thumb and forefinger trace the base line down to the 3<sup>rd</sup> finger trap ensuring there are no full twists.
- k. Trace each cascade line attached to the base line ensuring there are no full twists and that each line is attached to the appropriate corresponding attaching loop.

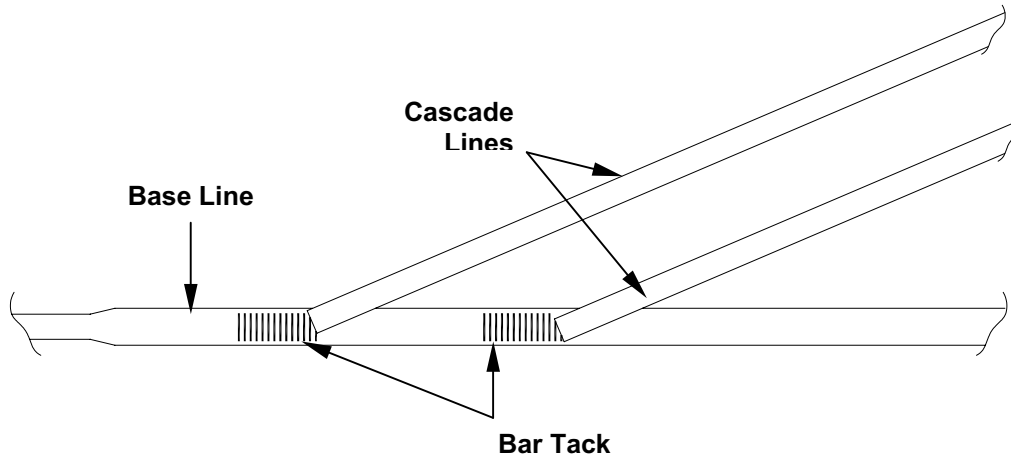

- l. Starting with line 1C trace the line to the bar tack using the thumb and forefinger and remove all twist. Trace line 1D from the bar tack to the canopy-attaching loop then continue tracing line 1C from the bartack to the canopy-attaching loop.
  - m. Using procedures from step l., above, trace lines 2C and 2D through 8C and 8D.
  - n. Starting with line 1A, trace the line up to the bar tack using thumb and forefinger and remove all twists. Trace line 1B from the bar tack to the canopy-attaching loop the continue tracing line 1A to the canopy-attaching loop.
  - o. Using procedures in step n., above, trace lines 2A and 2B, 3A and 3B, 6A and 6B, 7A and 7B, and 8A and 8B.
  - p. Lines 4A and 5A are continuous. Trace each line from the connector link to the canopy attaching loops ensuring there are no full twists and that line 4A and 5A are attached to the nose of the canopy.
5. Using  $\frac{7}{16}$ -inch open-end wrench, tighten barrel nut on connector links  $\frac{1}{4}$  turn past hand tight.

6. Hand tack each riser below the connector link with one turn double tape lacing and tying with an overhand knot.

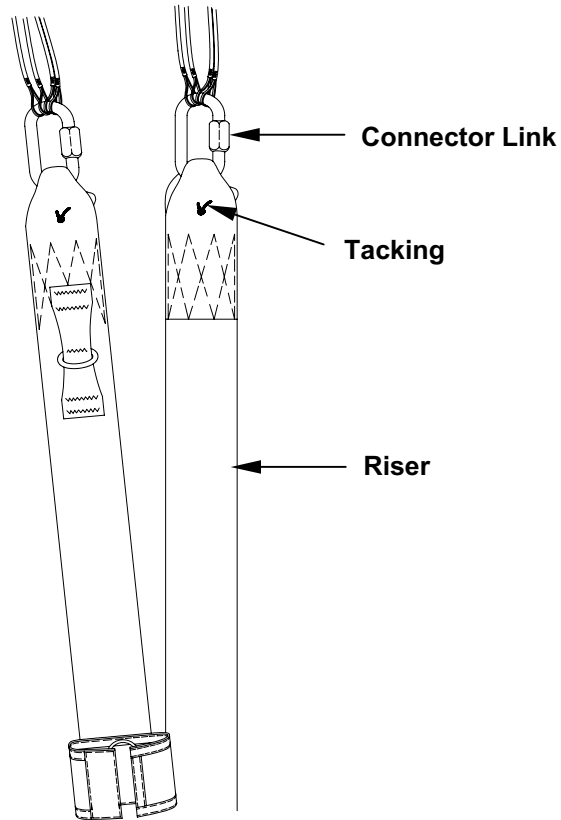

7. Remove parachute from hanging device and place in proper layout.

#### APPLICATION OF MARKINGS

Apply markings as follows:

#### NOTE

When a parachute component is placed in service, the month and year of date placed in service shall be marked on it.

1. Canopy. On cell with data block.
2. Harness/container. On left diagonal back strap near the data label. ■
3. Pilot chute. Anywhere on fabric area that will be visible after marking.
4. Slider. Anywhere on fabric area that will be visible after marking.
5. Risers. Stencil riser on fabric, in suitable location (near data tag).
6. Allow markings to dry 20 to 30-minutes.

**ATTACHMENT OF CONTROL TOGGLES TO CONTROL LINES**

Attach control lines to control toggles as follows:

1. Pass control lines through guide rings on rear risers, and then through rings on control toggles.
2. Temporarily secure control lines to rings with a loose overhand knot against toggle ring.

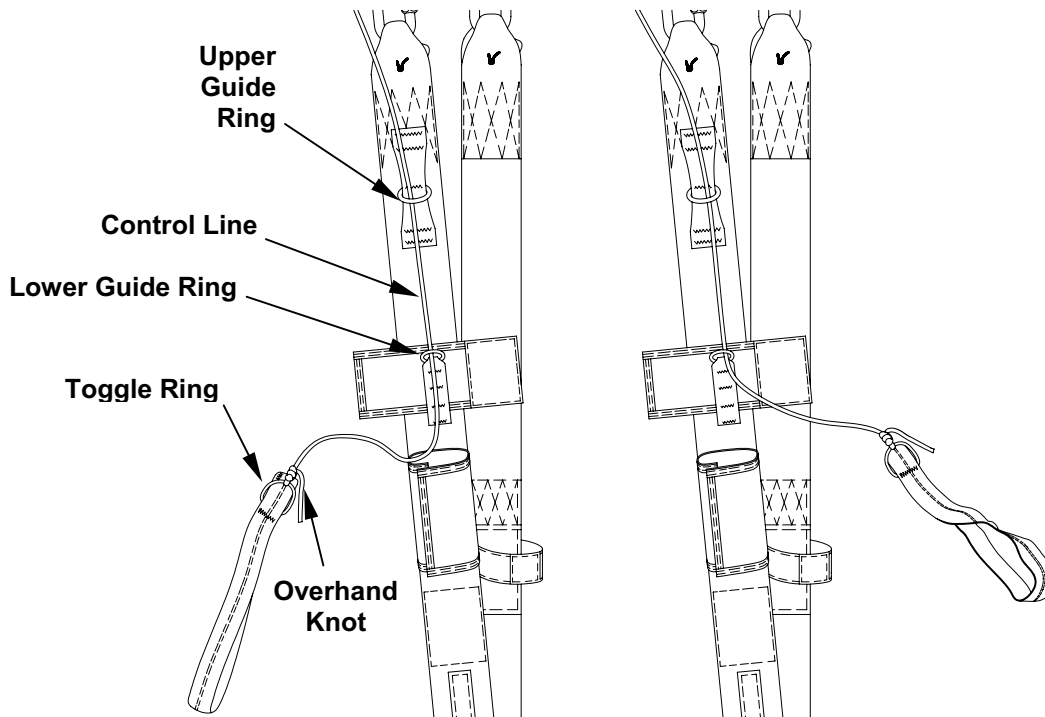
**NOTE**

Final adjustment will be made during full-flight trim check (WP 0006 00).

**ATTACHMENT OF PILOT CHUTE, BRIDLE LINE, AND DEPLOYMENT BAG**

Attach pilot chute, bridle line, and deployment bag as follows:

1. Pass bridle line loop at ring end through deployment bag top grommet from outside to inside.
2. Pass bridle line loop at ring end completely through bridle line attachment ring on top of canopy.
3. Pass opposite end of bridle line and deployment bag through loop at end ring. Pull tight forming a girth hitch.
4. Pass other loop end of bridle line through 1-inch loop at bottom end of pilot chute.

5. Pass entire pilot chute through loop. Pull tight forming a girth hitch.

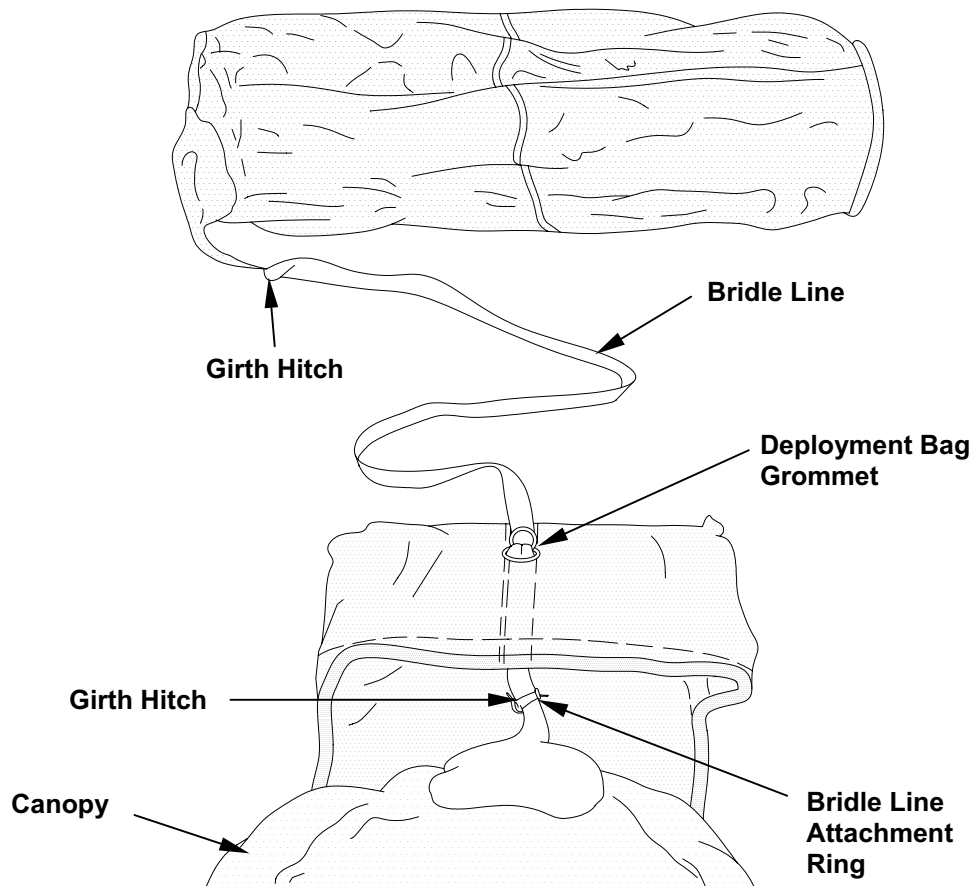

### CANOPY TRIM CHECK

Perform canopy trim check as follows:

1. Using the equipment D-rings, attach the container to a stationary point, ensuring equal tension, with the harness down and container facing up.
2. Obtain suspension line group separation and place canopy with the nose down and the tail facing up.

3. Pull control lines down until finger-trapped loops are below lower control line guide rings.

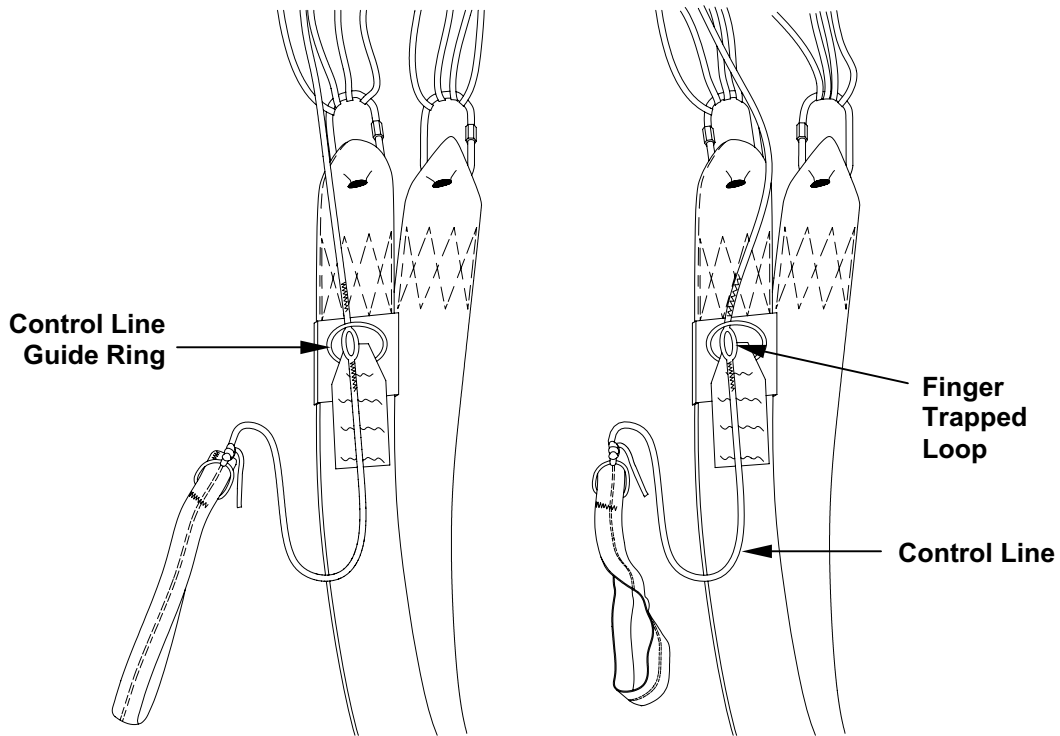

4. Move right finger-trapped loop and riser strap to left riser strap. Insert toggle thong through both finger-trapped loops.

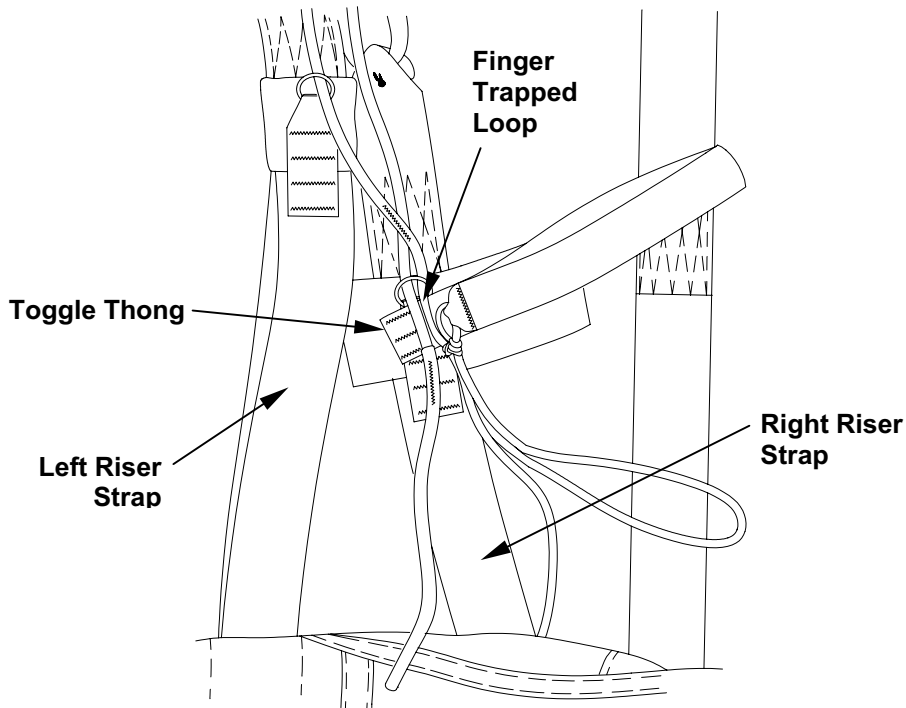

- With the toggles inserted in the finger-trapped loops, locate lines 1A and 8A.

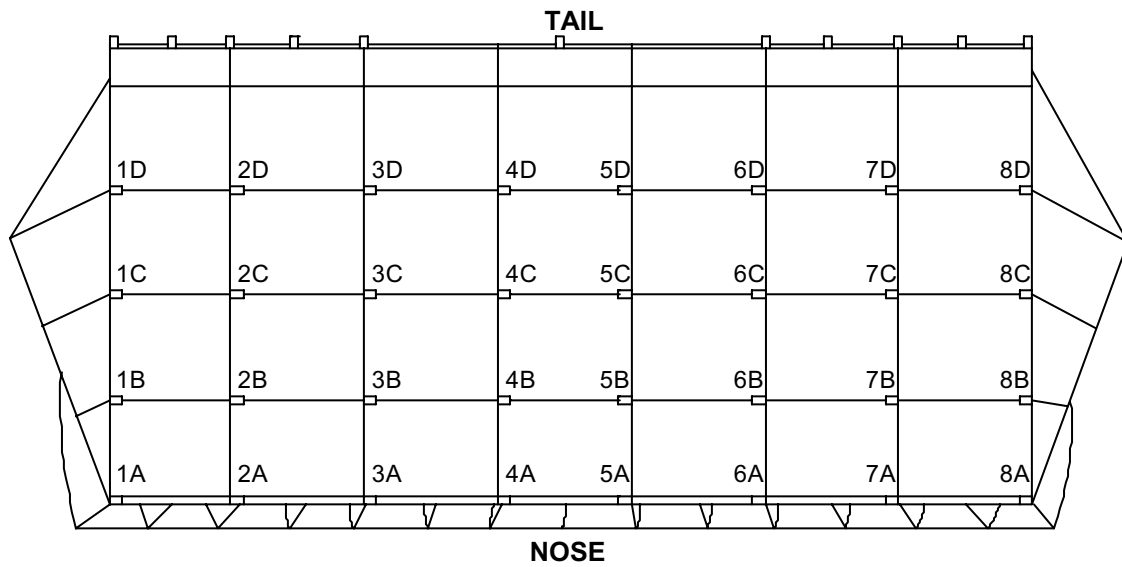

**NOTE**

Pull both lines evenly before looking at the ruler to ensure an accurate measurement can be obtained.

- Grasp canopy fabric near line 1A attaching loop. Moving to center of canopy pull line 1A and the control line on the right front riser and compare lengths to ensure control line is 15-inches ( $\pm 1$ -inch) longer than line 1A.

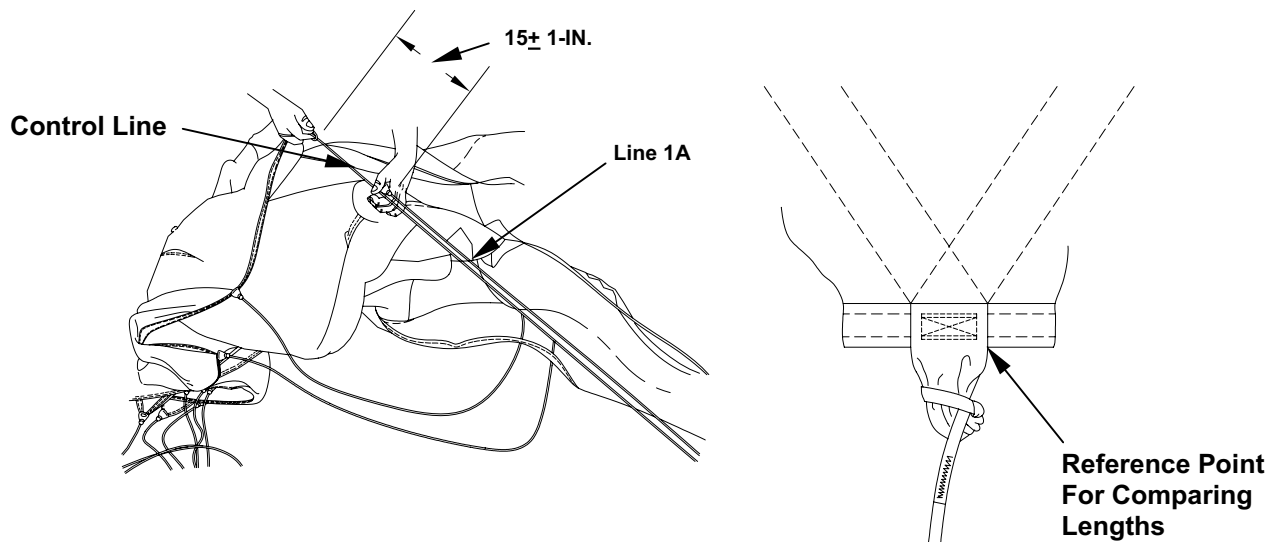

7. Grasp base line of the right control line and compare the cascade lines to the base line and ensure they are even ( $\pm 1/2$ -inch).

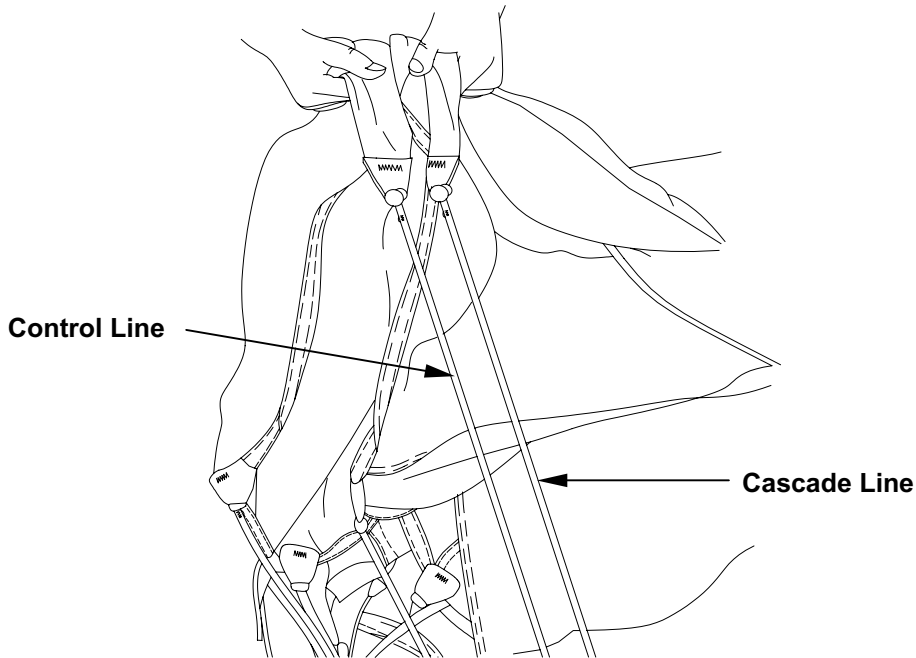

8. Grasp canopy fabric near line 8A attaching loop. Moving to center of canopy pull line 8A and the control line on the left rear riser and compare lengths to ensure control line is 15-inches ( $\pm 1$ -inch) longer than line 8A.

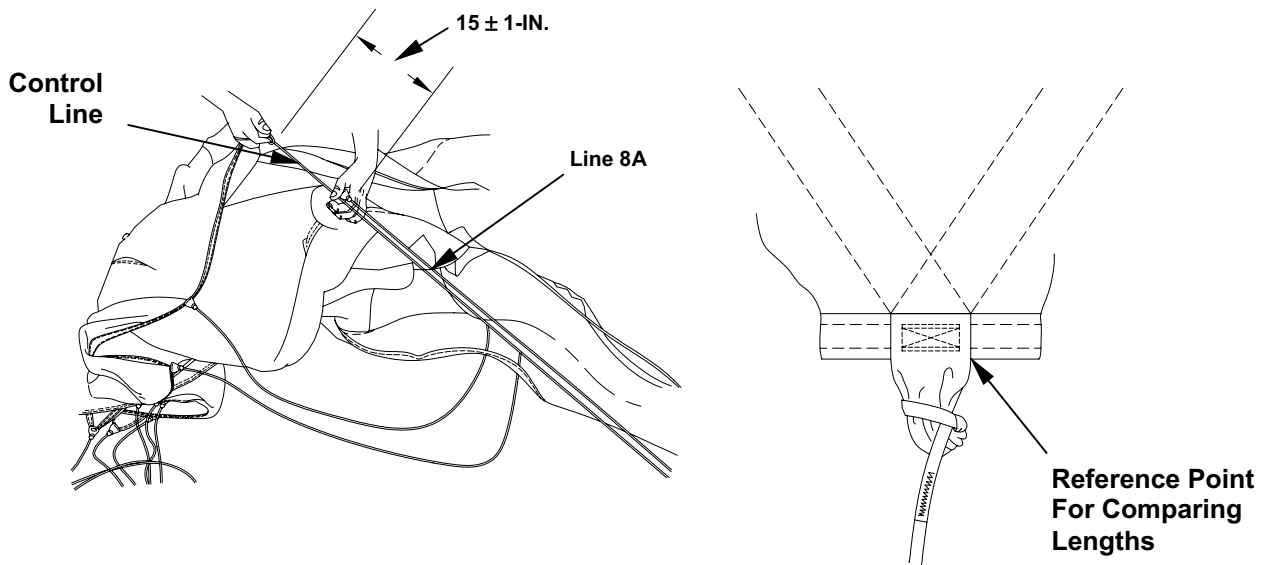



9. Grasp the base line of the left control line and compare the cascade line to the base line and ensure they are even ( $\pm 1/2$ -inch).

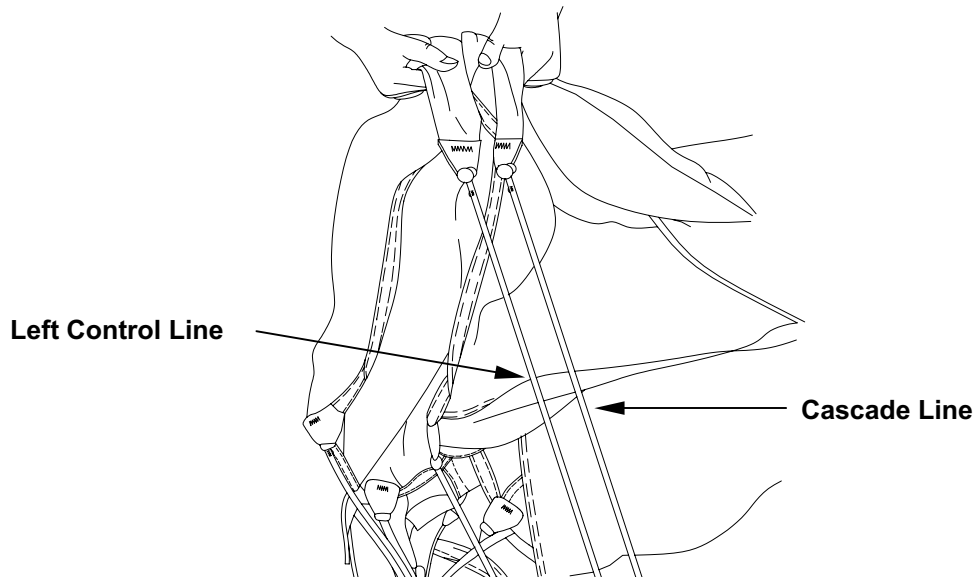

10. Move to the trailing edge of the canopy (tail). Grasp canopy fabric near both main control line attachment loops. Pull control lines and compare to ensure lengths are equal within  $1/2$ -inch.

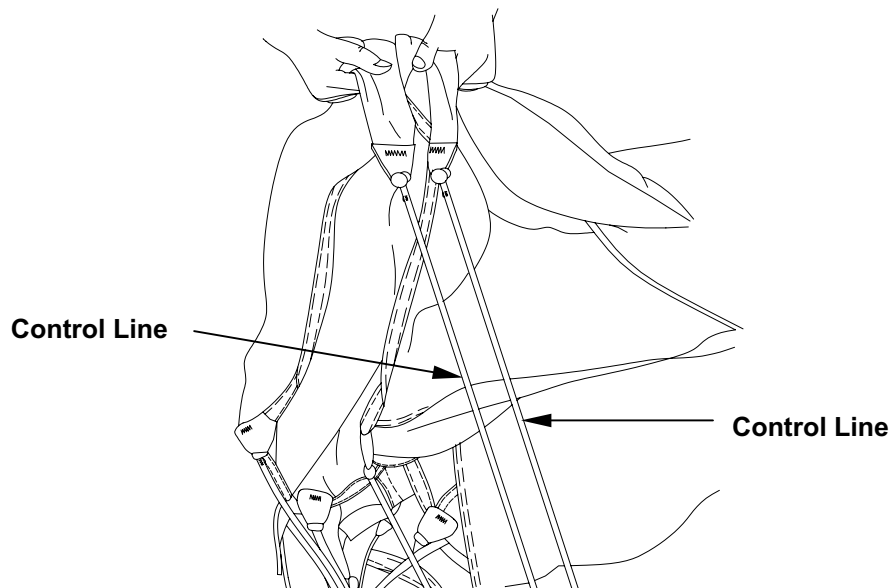

11. Remove toggles from finger trap loop.
12. Move to leading edge of canopy and ensure connector links are held even with one another.

13. Grasp canopy fabric near lines 1A and 1B attachment points. Moving to center of canopy stretch and compare lengths. Line 1B should be 3-inches ( $\pm 1$ -inch) longer than line 1A.

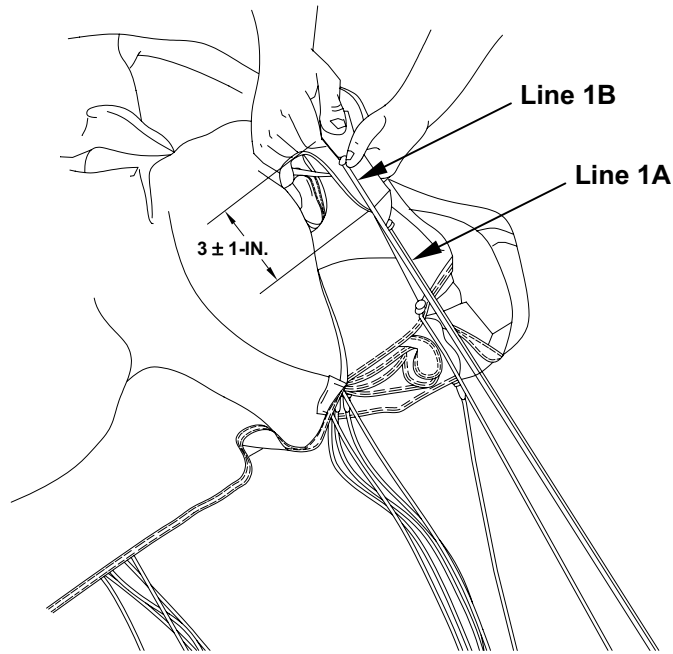

14. Grasp canopy fabric near lines 1B and 1C attachment points. Moving to center of canopy, stretch and compare lengths. Line 1C should be 9-inches ( $\pm 1$ -inch) longer than line 1B.

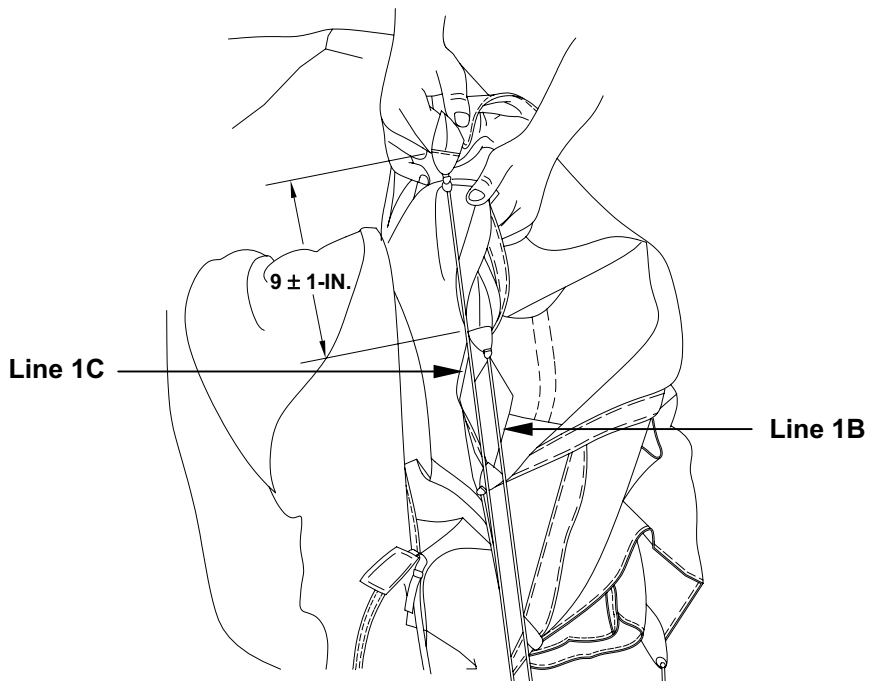

15. Grasp canopy fabric near lines 1C and 1D attachment points. Moving to center of canopy stretch and compare lengths. Line 1D should be 12-inches ( $\pm 1$ -inch) longer than line 1C.

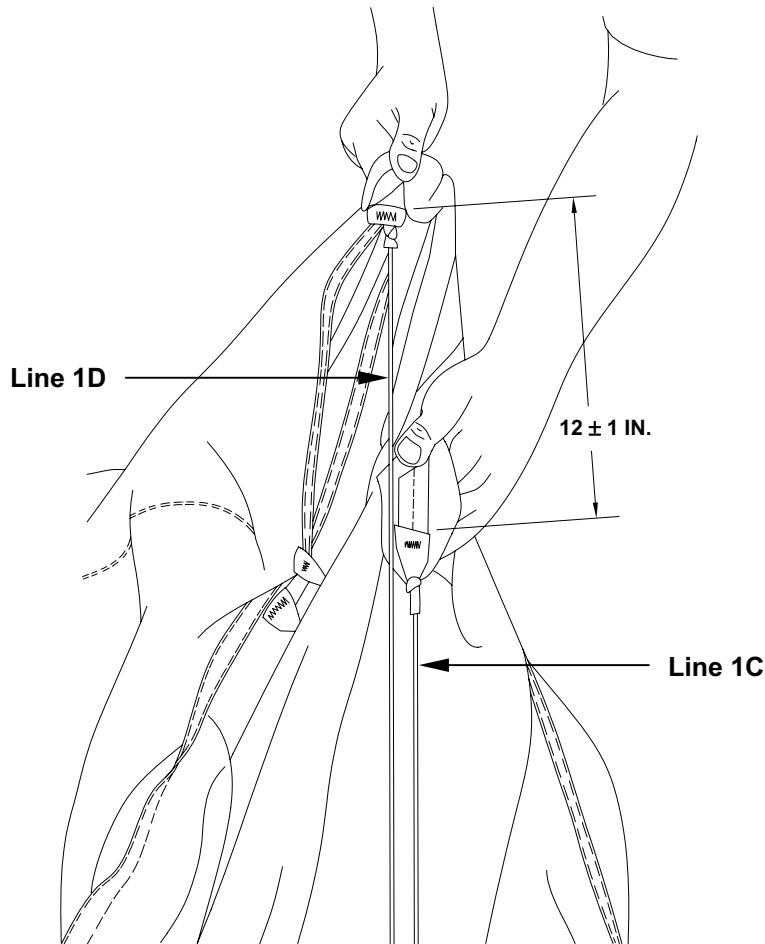

16. Move to trailing edge of canopy and ensure connector links are held even with one another. ■
17. Locate line 1D and 8D.

**NOTE**

Pull both lines evenly before looking at ruler to ensure an accurate measurement can be obtained. Adjust knot at the toggle to obtain correct length.

18. Grasp canopy fabric near line 1D attaching loop. Moving to center line of canopy, pull line 1D and the control line on the right riser and compare lengths to ensure control line is 15-inches ( $\pm 1$ -inch) longer than line 1D.

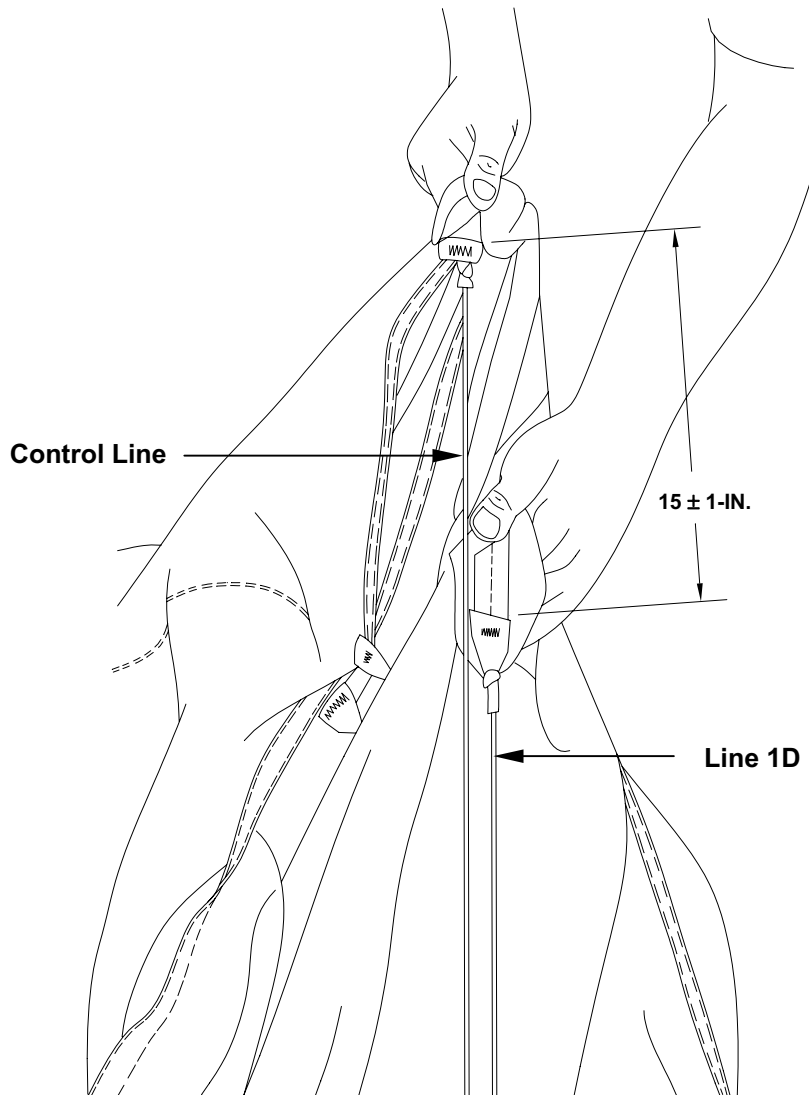

**NOTE**

Pull both lines evenly before looking at ruler to ensure an accurate measurement can be obtained. Adjust knot at the toggle to obtain correct length.

19. Grasp canopy fabric near line 8D attaching loop. Moving to center of canopy pull line 8D and the control line on the left riser and compare lengths to ensure control line is 15-inches ( $\pm 1$ -inch) longer than line 8D.

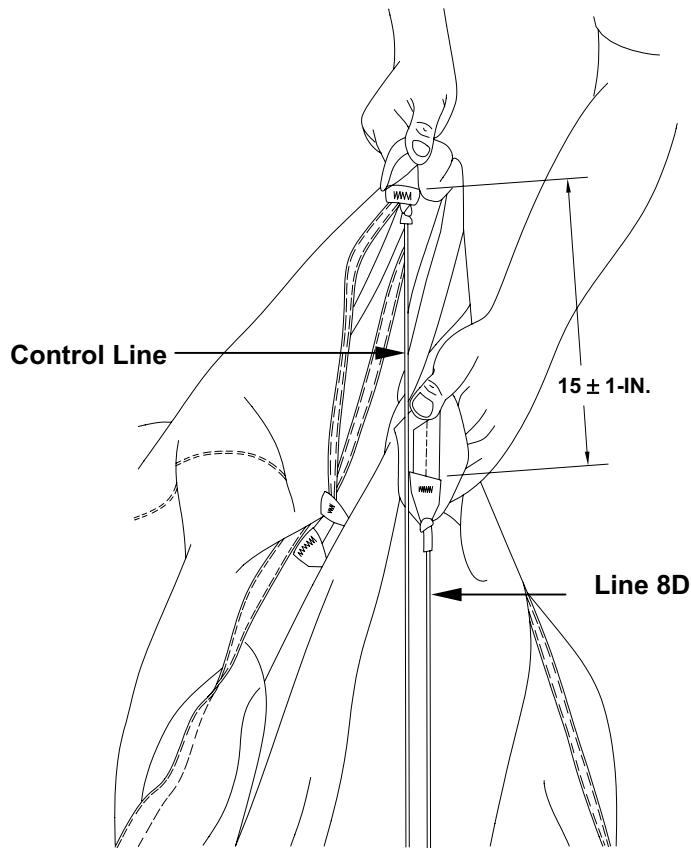

20. Move to the trailing edge of the canopy. Grasp canopy fabric near both main control line-attaching loops. Pull control lines and compare to ensure lengths are equal ( $\pm 1/2$ -inch).

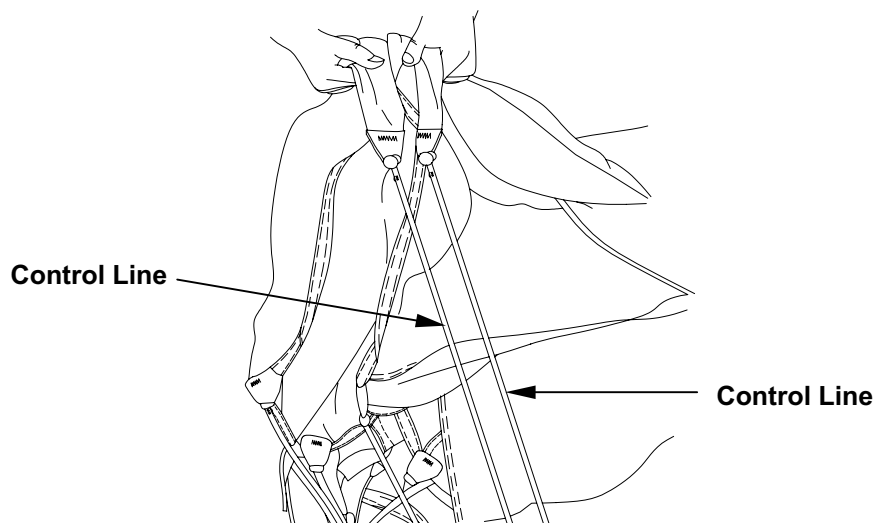

**NOTE**

Ensure the knot is drawn tight against the toggle ring.

21. Permanently secure control line knot formed below. Trim the running end to the length of the toggle.

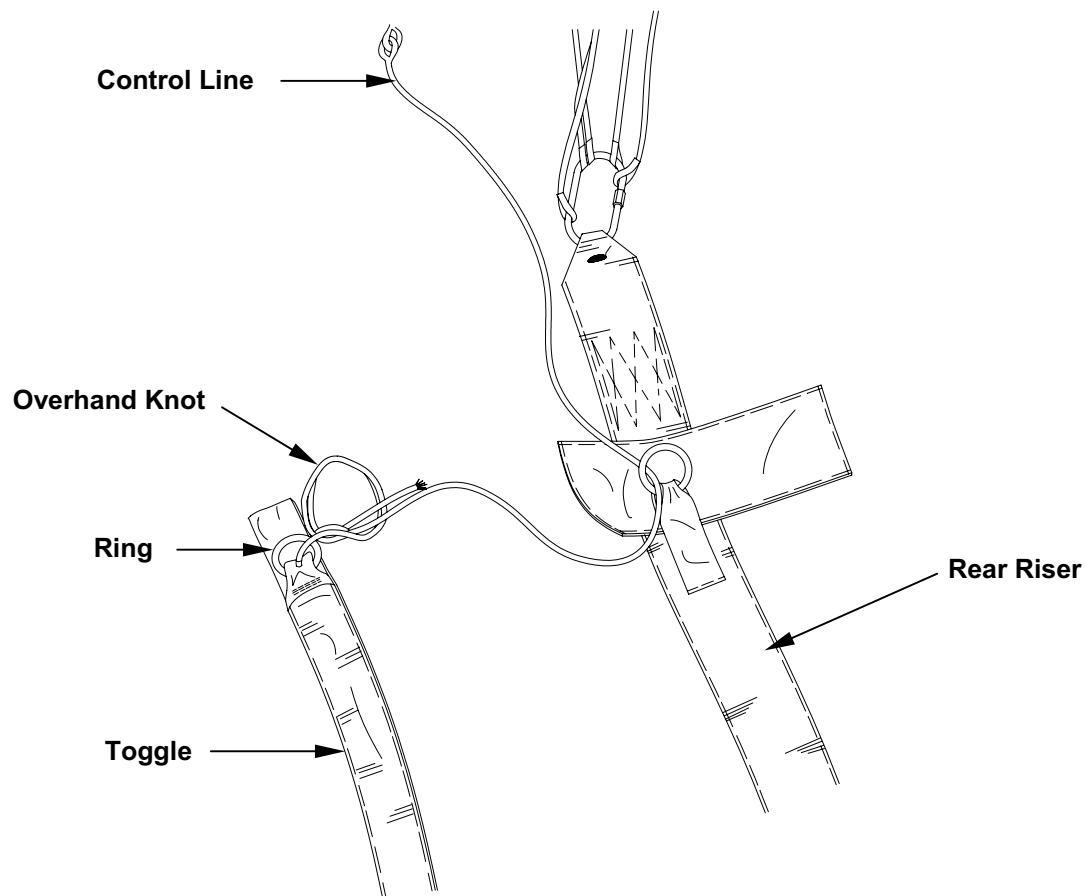
**SPANWISE LINE CHECK**

Perform spanwise line check as follows:

1. Lay out parachute on a clean dry surface with canopy positioned on its left side. Leading edge (nose) will be on right when viewed from riser end. Stretch lines full length with a helper positioned at riser end to check continuity and to hold lines taut.

2. Grasp high points of each cell and flip canopy toward trailing edge. Canopy shall lie flat with trailing edge lines on left side when viewed from riser end.

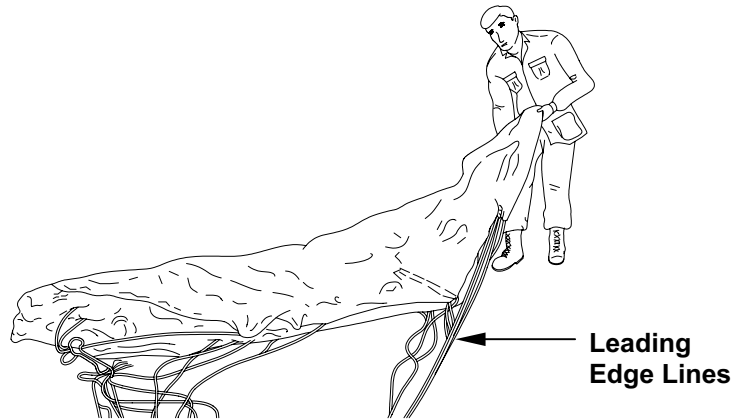

3. Beginning with line 1A, compare each line in the A group. The maximum allowable difference between that line and any other line is 1/2-inch.
4. Repeat step 3., for B, C, and D line groups.

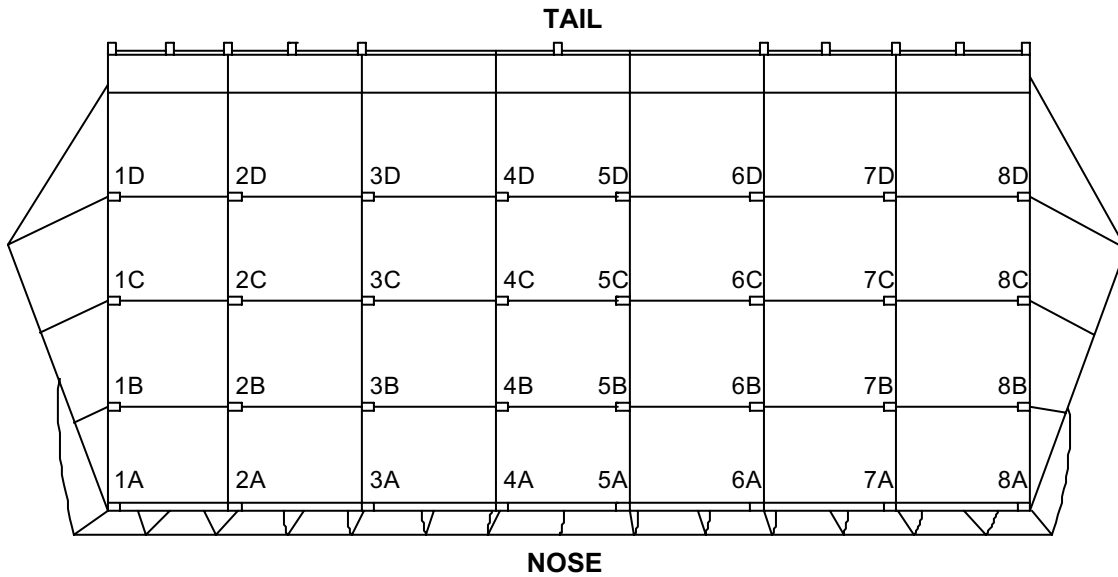

END OF WORK PACKAGE





---

**MC-4 RAM AIR FREE-FALL PERSONNEL PARACHUTE SYSTEM  
PREVENTIVE MAINTENANCE CHECKS AND SERVICES (PMCS), INTRODUCTION**

---

**GENERAL**

The following describe PMCS procedures on the unit and direct support levels. The PMCS table has been provided to ensure the MC-4 parachute is in proper operating condition, and ready for its primary mission.

**SCOPE**

The following work packages (WP 0015 00 through WP 0059 00) contain maintenance procedures that are the responsibility of the specified technician, as authorized by the Maintenance Allocation Chart (MAC), and the Source, Maintenance, and Recoverability (SMR) coded items that are identified in the Repair Parts and Special Tools List (RPSTL).

**MAINTENANCE FUNCTIONS/PROCEDURES**

Each of the mentioned work packages above identifies a maintenance function specified in the MAC. All maintenance procedures required to complete a maintenance function are identified under THIS TASK COVERS: in the order in which the work is most logically accomplished.

**PARACHUTE REPACK INTERVAL**

The MC-4 parachute will be repacked at a scheduled interval to insure airworthiness. When necessitated by climate/storage/use condition, the local airdrop equipment maintenance officer may require more frequent repack intervals. In this regard, a major concern would be rapid fluctuations of temperature (fluctuations around 32 degrees Fahrenheit, freezing point) sustained high or low temperature, or high humidity and heavily polluted atmosphere. The MC-4 Ram Air Personnel Parachute System will be repacked at a 120-day interval (both main and reserve).

**DROP TESTING CRITERIA**

Drop testing of the MC-4 Ram Air Personnel Parachute System consist of physically airdropping an item from an aircraft in flight. The drop-test is used as a means of proving the serviceability of an item or checking parachute rigger proficiency, and will only be performed under the supervision of qualified parachute rigger personnel who satisfy the supervisory requirements outlined in AR 750-32 and TM 10-1670-201-23. Drop testing will usually be conducted by an activity responsible for the inspection and maintenance of airdrop equipment, which includes either parachute packing or airdrop load rigging. The criteria required to accomplish a drop test is as follows:

1. To drop-test a troop-type personnel parachute, a qualified parachute rigger will jump the parachute and the applicable type parachute will be released under conditions that are consistent with the requirements for a personnel jump or equipment drop.
2. During the drop-test of any type parachute, the deployment of the parachute will be thoroughly monitored and observed to detect any indication of malfunction or defect. A subsequent record of the applicable parachute log record will be entered into the applicable log record using procedures outline in WP 0004 00.
3. Any type of airdrop equipment that indicates evidence of malfunction/defect during, or after, a drop-test will be disposed of as prescribed in WP 0011 00.
4. A personnel parachute that is considered to have contributed to the injury of an individual parachutist (critical or fatal) will be disposed of in accordance with WP 0011 00, Equipment Disposition.
5. Airdrop equipment that does not reflect evidence of malfunction or defect upon completion of a drop-test will be administered a technical/rigger-type inspection as outlined in WP 0011 00. If serviceable, the item(s) may then remain in use.

**END OF WORK PACKAGE**



---

**MC-4 RAM AIR FREE-FALL PERSONNEL PARACHUTE SYSTEM  
PREVENTIVE MAINTENANCE CHECKS AND SERVICES (PMCS)**

---

**GENERAL**

The following describe PMCS procedures on the unit and direct support levels. The PMCS table has been provided to ensure the MC-4 parachute is in proper operating condition and ready for its primary mission.

**Warnings and Cautions.** Warnings and cautions appear before applicable procedures. You must observe these WARNINGS and CAUTIONS to prevent serious injury to yourself and others, and to prevent damage to equipment.

**Frequency of Performing PMCS.** PMCS will be performed before equipment is packed for use, during modification and repair after use, or at any time deemed necessary by the air delivery equipment maintenance officer.

**PMCS Columnar Entries Table 1.**

**Item Number.** The item number column shall be used as a source of the item number required for the TM Number column on DA Form 2404 (Equipment Inspection and Maintenance Worksheet), when recording the results of the PMCS.

**Interval.** This column identifies the required PMCS interval.

**Item to be Inspected.** Contains the common name of the item to be inspected.

**Procedures.** Provides a brief description of the procedures by which the checks are to be performed.

**Recording Defects.** All defects discovered during the inspection will be recorded using the applicable specifics in DA Pamphlet 750-8, DA Pamphlet 738-751 and TB 43-0002-43.

**Over Age Items.** During any inspection, or at any time that an item is found to be over age (i.e., shelf/service-life has expired as specified in TB 43-0002-43), the item will be removed from service, condemned, and tagged, in accordance with DA PAM 738-751.

**Conservation of Resources.** To conserve time and labor, and to avoid evacuation to a direct support maintenance activity, unit/detachment commanders may designate, in writing, rigger personnel to accomplish classification inspection of over age air delivery equipment and the classification of Beyond Economical Repair (BER) parachutes.

**Inspection Function Requirement.** Normally, air delivery equipment maintenance personnel at a packing, rigging, or repair activity will perform a technical/rigger-type inspection. The inspection of initial receipt items will be performed as a separate function from packing or rigging activity; the item to be inspected will be placed in proper layout on a packing table or suitable sized floor area.

Should defect or damage be discovered at any point during the inspection, the inspection will be terminated and the applicable item will be processed and forwarded to repair activity. The repair activity, in turn, will conduct a technical/rigger-type inspection that will be performed by only those parachute rigger personnel cited in AR 750-32. The repair activity inspection of personnel parachutes will be made on the light table.

Any defect discovered during a unit level repair activity inspection, that exceeds the capability of that activity, will require the affected item to be evacuated to a direct support maintenance function.

**NOTE**

Parachutes that are deemed unserviceable, by a packing or rigging activity, will be rigger-rolled (see the ACCORDION FOLDING/RIGGER ROLLING paragraph detailed in WP 0061 00) prior to being sent to a repair activity.

**Table 1. Preventive Maintenance Checks and Services**

**X** – Before and after all repairs, and before packing (technical/rigger type inspection).      **Y** – After use (shakeout).      **Z** – Prior to issue (routine inspection).

ITEM NO.	Interval			ITEM TO BE INSPECTED	PROCEDURES
	X	Y	Z		
00				MC-4 System	
01			•	Parachute (Packed for Use)	Check for serviceability and completeness of visible parts without opening container. Pack date in parachute log record.
02	•	•		Canopies and Riser Assemblies	Check for dampness, fungus, acid, grease, oil, foreign material, holes, cuts, tears, and broken lines as canopy is raised, lowered, and suspended during shakeout.
03	•	•		Canopy Fabric Materials	Check for legibility and completeness of marked data; dampness, fungus, dirt, acid, grease, oil, foreign material, rips, burns, cuts, breaks, frays, tears, holes, and loose or broken stitching on fabric and lines.
04	•			Hardware	Check for corrosion, rust, rough spots, burrs, breaks, cracks, bends, and stripped or damaged threads.
05	•	•		Risers	Check for dampness, fungus, acid, grease, oil, dirt, foreign material, cuts, tears, and frays.
06	•	•		Riser Fabric Materials	Check for dampness, fungus, dirt, acid, grease, oil, foreign material, burns, cuts, tears, broken or loose stitching, excess line keepers, reserve static line release lanyard, main canopy release locking loop, and riser release rings.
07	•			Riser Hardware	Check for corrosion, rust, rough spots, burrs, breaks, cracks, bends, and stripped or damaged threads.
08	•	•		Pilot Parachutes	Check for dampness, acid, grease, oil, and dirt, foreign material, and broken springs.

**Table 1. Preventive Maintenance Checks and Services (CONT)**

**X** – Before and after all repairs, and before packing (technical/rigger type inspection).

**Y** – After use (shakeout).

**Z** – Prior to issue (routine inspection).

ITEM NO.	INTERVAL			ITEM TO BE INSPECTED	PROCEDURE
	X	Y	Z		
09	●	●		Pilot parachute fabric materials	Check for dampness, fungus, acid, grease, oil, dirt, foreign material, rips, burns, cuts, frays, tears, holes, thin spots, and loose or broken stitching.
10	●			Pilot parachute hardware	Check for cracks, rust, distorted or broken springs.
11	●	●	●	Harness/container assembly	Check for dampness, fungus, acid, grease, oil, dirt, cuts, and broken webbing.
12	●	●	●	Harness fabric material	Check for dampness, fungus, acid, grease, oil, dirt, cuts, broken webbing, and loose or broken stitching.
13	●		●	Hardness hardware	Check for corrosion, cracks, rust, rough spots, burrs, and distortion.
14	●	●	●	Container assembly	Check for dampness, fungus, acid, oil, grease, dirt, foreign material, holes, and tears.
15	●	●	●	Container fabric materials	Check for dampness, fungus, acid, oil, grease, dirt, foreign material, cuts, tears, and holes.
16	●		●	Container hardware	Check for corrosion, cracks, rust, rough spots, burrs, loose or missing grommets or snap fasteners.
17	●	●		Deployment bags	Check for dampness, fungus, acid, grease, oil, dirt, foreign material, cuts, holes, tears, broken or loose stitching, loose or missing grommets, and burrs/rough spots on grommets.
18	●		●	RipCORDS	Check for corrosion, cracks, rust, bends, fraying, broken strands, and security of swaged terminal balls and ripCORD pins.

**LUBRICATION SERVICE INTERVALS**

The MC-4 Ram Air Personnel Parachute System 3-Ring Riser Release requires lubrication every 120-days (WP 0011 00).

**END OF WORK PACKAGE**



**CHAPTER 3**  
**UNIT MAINTENANCE INSTRUCTIONS**  
**FOR**  
**MC-4 RAM AIR FREE-FALL**  
**PERSONNEL PARACHUTE SYSTEM**





---

**MC-4 RAM AIR FREE-FALL PERSONNEL PARACHUTE SYSTEM  
SHAKEOUT AND AIRING**

---

**THIS TASK COVERS:**

- Shakeout
  - Airing
- 

**INITIAL SETUP:****Tools**

Brush, Scrub, Household (Item 4, WP 0063 00)

**Personnel Required**

92R (10) Parachute Rigger

**Equipment Condition**

Parachute Suspended.

**SHAKEOUT**

A two-person team, either indoors within a shakeout room or outdoors at a shakeout tower, will accomplish the shakeout. Shake out is accomplished by elevating the tail seam (ensuring nose is off the ground) and vigorously shaking all debris out of each cell. Each parachute will be suspended and all debris removed by shaking the canopy thoroughly or by brushing with a dry, soft-bristled brush, as detailed below:

1. With assistance from the No. 2 person, the No. 1 person will gather the control lines on the left and right side of the canopy and wrap them two (2) times around the snap.

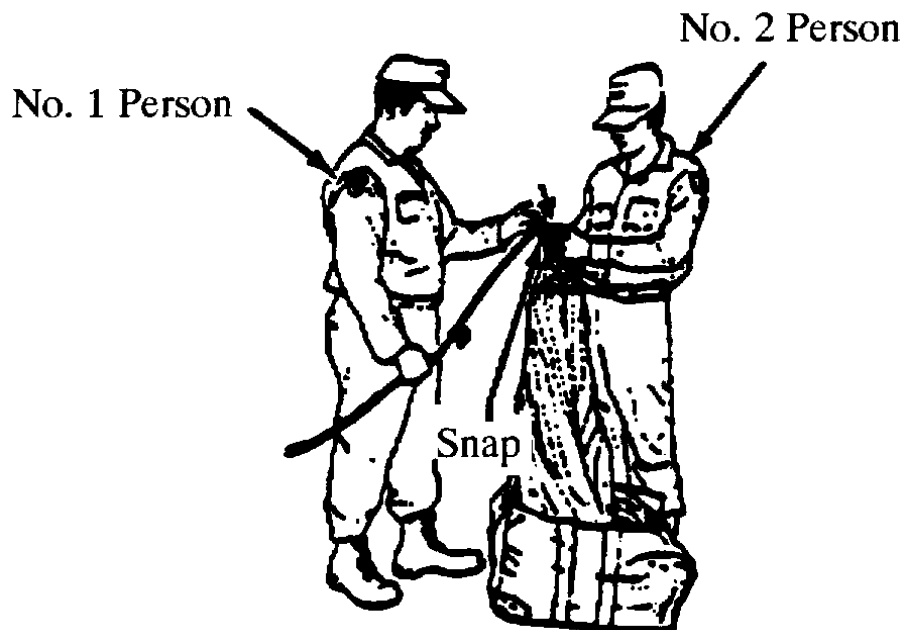

2. Through use of the pulley rope, the No. 2 person will raise the tail of the canopy to a suitable height; this will enable the No. 1 person to perform shakeout on each of the canopy cells. Until the cell shaking process is completed, the No. 2 person will maintain a steady pull on the pulley rope to hold the suspended canopy at the working height needed by the No. 1 person.

3. The No. 1 person will grasp any two-consecutive suspension lines, one in each hand, and vigorously shake the first cell.

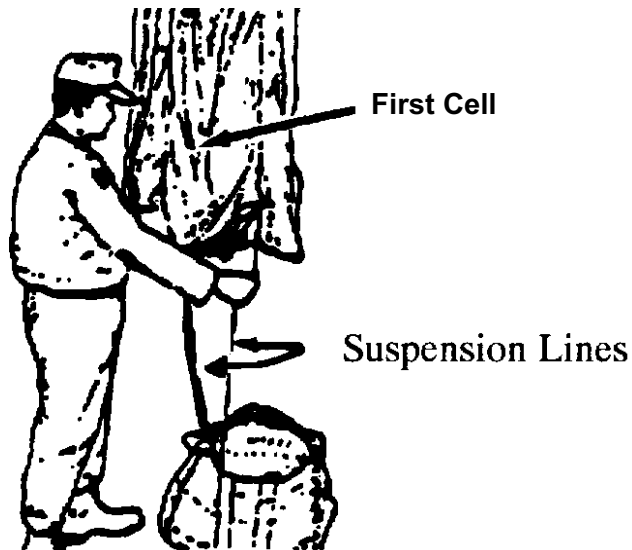

4. When the cells are free of debris, the No. 1 person passes the line from the right hand to the left hand and grasps the next consecutive suspension line, in the right hand. The No. 1 person will shake out each consecutive cell until all suspension lines are held in the left hand, and all cells are free of debris.
5. Once the cell shaking process is completed, the No. 2 person will slowly raise the suspended canopy higher as the No. 1 person clears the suspension lines of debris and removes entanglements, when possible.

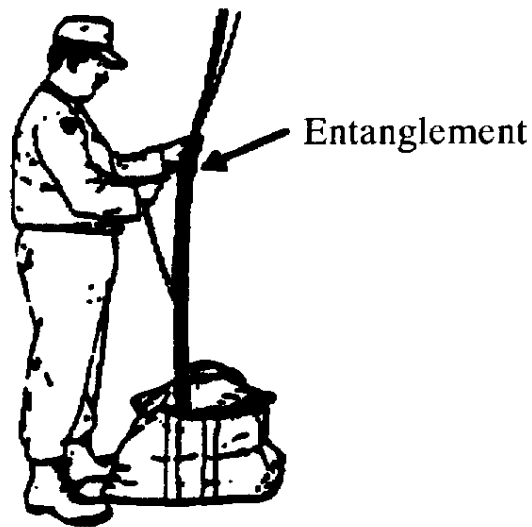

6. After the suspension lines have been cleared, the No. 2 person may hold, or temporarily secure, the pulley rope while the No. 1 person proceeds to clear debris from other parachute components such as the risers, harness/container.
7. When all components are free of debris, the No. 2 person will slowly lower the canopy, while the No. 1 person S-folds the suspension lines into the MC-4 kit bag, as applicable.



S-Fold Suspension Lines

8. After the suspension lines have been completely folded, the No. 1 person will accordion-fold the canopy length on top of the folded lines (see WP 0061 00).
9. As the canopy folding is being completed, the No. 1 person disconnects the canopy from the pulley rope snap. Secure the folded canopy assembly for further handling.

#### **AIRING**

Where dampness and mildew are prevalent, air delivery equipment will be aired at frequent intervals according to the severity of the prevailing conditions. Parachutes that have been previously packed or are unpacked, and have been subjected to conditions of dampness or mildew, will be aired for a period of at least 6-hours prior to being repacked. Air delivery items may be aired either indoors or outdoors, in dry weather. However, fabric items will not be aired in direct sunlight. Suspending or elevating the applicable item(s) in a manner that would allow maximum exposure to air circulation may accomplish airing. Outside facilities used for the shakeout of parachutes may be used for the airing of air delivery equipment, if weather conditions permit. If the shakeout facilities are inadequate for airing, the applicable item(s) may be suspended or elevate at several points, or draped over suitable type objects that will not cause damage.

**END OF WORK PACKAGE**



---

**MC-4 RAM AIR FREE-FALL PERSONNEL PARACHUTE SYSTEM  
CLEANING AND DRYING**

---

**THIS TASK COVERS:**

- Cleaning fabric items with dishwashing compound
  - Rinsing parachute assembly immersed in salt water
  - Rinsing parachute assembly immersed in fresh water
  - Drying fabric items
- 

**INITIAL SETUP:****Tools**

Brush, Scrub, Household (Item 4, WP 0063 00)  
File, Flat, 1-IN. (Item 15, WP 0063 00)

**Equipment Condition**

Laid out on packing table or other suitable surface.

**Materials/Parts**

Cloth, Abrasive (Item 6, WP 0076 00)  
Dishwashing Compound (Item 14, WP 0076 00)  
Rag, Wiping (Item 30, WP 0076 00)  
Cleaner, Industrial (Item 50, WP 0076 00)

**Personnel Required**

92R(10) Parachute Rigger

---



---

**WARNING**

---

Due to flammable properties and nylon-damaging substances, cleaning solvents other than EVERBLUM GOLD™ (industrial cleaner) will not be used in the spot-cleaning or airdrop equipment. EVERBLUM GOLD™ will only be used in areas where substantial ventilation is available. Repeated or prolonged inhalation of the solvent vapors can be detrimental to human health. In addition, avoid prolonged or repeated contact of the solvent fluid with areas of the skin. EVERBLUM GOLD™ must not be taken internally.

---

**CAUTION**

---

If during the cleaning there exists a possibility that the substance to be removed contains acid or some other equally destructive ingredient, the item will be evacuated to the intermediate maintenance activity for determination as to the nature of the substance and item disposition. If the substance cannot be identified or if normal repair procedures will not eliminate all traces of chemical or acid damage, the applicable item will be condemned.

---

**NOTE**

---

Cleaning of parachutes should be held to a minimum and should be performed only when necessary to prevent malfunction or deterioration. When a parachute contains debris, or when it is soiled by dirt, oil, grease, rust, corrosion or other foreign substances to such an extent that cleaning is necessary, the cleaning should be done manually and should be limited to the soiled area only, unless the parachute has been contaminated by water. The method of cleaning must be determined by the nature of the substance to be removed. Do not use cleaning solvent to clean item soiling caused by airsickness. Use a solution of hand dishwashing compound to clean this type of soiling.

**CLEANING FABRIC ITEMS WITH INDUSTRIAL CLEANING**

Use EVERBLUM GOLD™ (industrial cleaner) to clean fabric items as follows:

1. Gently brush with a soft bristle brush.
2. Spot clean with EVERBLUM GOLD™ industrial cleaner as follows:
  - a. Rub the soiled area with a clean dampened cloth with EVERBLUM GOLD™ industrial cleaner.
  - b. Rinse the cleaned area by repeating the rubbing process with the clean portion of the cloth dampened with the industrial cleaner.
  - c. Rub with a dry cloth to remove excess solvent and air dry.

**CLEANING FABRIC ITEMS WITH A SOLUTION OF HAND DISHWASHING COMPOUND**

Use dishwashing compound to clean fabric items as follows:

1. Gently brush with a soft bristle brush.
2. Spot clean with a solution of dishwashing compound.
  - a. Completely dissolve one-half cup of dishwashing compound in one-gallon of warm water.
  - b. Rub the soiled area with a clean cloth dampened with a solution of dishwashing compound.
  - c. Rinse the cleaned area by repeating the rubbing process, with a clean portion of the cloth dampened with water.

**RINSING PARACHUTE ASSEMBLY IMMERSSED IN SALT-WATER**

If the parachute, or any of its components, has been immersed in salt water in excess of 24-hours it will be condemned. Additionally, if the parachute, or any of its components, has been immersed in salt-water for a period less than 24-hours, but cannot be rinsed within 48-hours after recovery, it will also be condemned, unless the following actions are performed. Upon removal from the salt water, the parachute is placed in a single heavy-duty plastic trash bag, the top of the bag secured closed and kept in a wet state until a rinse can be performed following normal rinse procedures. The bag must be doubled when outside temperatures exceed 85 degrees F. The bags must be inspected after transport and storage to ensure the bag did not get torn and the assembly was allowed to dry. Parachutes recovered using this method must be rinsed NLT than seven (7) days after the salt-water immersion or be condemned. However, if the cited time limitations can be met, then immediately upon recover, suspend or elevate the parachute assembly in a shaded area and allow it to drain for at least 5-minutes. Do not attempt to wring the fabric or the suspension lines. Within 48-hours after recover, under the supervision of a qualified parachute rigger (92R), rinse the recovered parachute assembly as follows:

1. Place the parachute assembly in a large watertight container filled with a suitable amount of fresh, clean water to cover the assembly.

**NOTE**

If the salt-water-soaked parachute assembly is too large to be placed into a rinsing container, then the rinsing process will be affected by applying fresh, clean water to the assembly using a hose.

2. Agitate the container contents by hand for 5-minutes.
3. Remove the parachute assembly from the container and suspend or elevate it in a shaded area, allowing a 5-minute drainage period. Do not attempt to wring the fabric or the suspension lines.
4. Repeat the procedures in steps 1. through 3. above, two more times, using fresh, clean water for each rinse.
5. After the third rinse, allow the parachute assembly to drain thoroughly. Upon completion of draining, dry the assembly in accordance with the DRYING FABRIC ITEMS procedures, below.
6. When dried, perform a technical/rigger-type inspection of the parachute assembly. Corroded metal components, or corrosion-stained fabrics or suspension lines, will be either repaired or replaced as prescribed by the Maintenance Allocation Chart (MAC) in WP 0063 00.
7. Record any repair, immersion, and rinsing in the parachute log record as shown in WP 0004 00.

**RINSING PARACHUTE ASSEMBLY IMMERSSED IN FRESH-WATER**

Any parachute, or its components, that has been immersed in a fresh water lake, river, or stream will not require rinsing unless it has been ascertained that the water is dirty, oily, or otherwise contaminated. Procedures for handling a fresh water immersed parachute are as follows:

1. Contaminated fresh-water. If the parachute, or its components, has been immersed in contaminated fresh-water, rinse and dry (see RINSING PARACHUTE ASSEMBLY IMMERSSED IN SALT-WATER, above), and, if applicable, repair.
2. Uncontaminated fresh-water. If the parachute, or its components, has been immersed in uncontaminated fresh-water, it will be cleaned and dried as outlined in CLEANING FABRIC ITEMS WITH A SOLUTION OF HAND DISHWASHING COMPOUND, DRYING FABRIC ITEMS, and CLEANING METAL ITEMS, in the detailed paragraphs above and below. Minor discoloration of fabric items, resulting from immersion in uncontaminated fresh-water, may occur.

NOTE

Fabric items will not be dried in direct sunlight or by laying an item on the ground.

**DRYING FABRIC ITEMS**

Dry fabric items as follows:

1. Suspend or elevate the item in a well-ventilated room or in a heated drying room.
2. Using electric circulating fans may reduce drying time.
3. When heat is used, the heat temperature shall not exceed 160 degrees Fahrenheit (71 degrees Celsius). The preferred temperature is 140 degrees Fahrenheit (60 degrees Celsius).

**END OF WORK PACKAGE**



---

## MC-4 RAM AIR FREE-FALL PERSONNEL PARACHUTE SYSTEM INSPECTION

---

**THIS TASK COVERS:**

- Routine
  - Pack-In-Process
  - Technical/Rigger-Type
  - 3-Ring Release Riser Inspection
  - Slack Checker
  - In-Storage
  - Equipment Disposition
- 

**INITIAL SETUP:**

**Equipment Condition**  
Packed.

**Personnel Required**  
92R (10) Parachute Rigger  
92R (20) Parachute Rigger

**References**

DA PAM 738-751  
TB 43-0002-43  
DA PAM 750-8  
AR 750-1

---

**ROUTINE INSPECTION**

A routine inspection is a visual check performed to ascertain the serviceability of all visible components of a parachute that is packed or rigged for use. The inspection will be made on all components that can be inspected without opening the parachute pack.

Prior to issue, a parachute rigger will administer this inspection. Personnel parachutes issued for an air delivery operation and not deployed will receive a routine inspection prior to being placed into ready-for-issue storage.

**PACK-IN-PROCESS INSPECTION**

A pack-in-process inspection is performed at specified intervals during the packing of a parachute to ensure that only authorized procedures and methods are being used.

A parachute rigger other than the packer or rigger preparing the applicable equipment for use will accomplish the inspection. The intervals, at which the inspection is performed, are as follows:

---

**NOTE**

---

For Army personnel, the In-Process Inspector (IP) qualifications are IAW AR 750-32.

**TECHNICAL/RIGGER-TYPE INSPECTION PROCEDURES**

Perform inspection as follows:

1. Overall inspection. An overall inspection will be made on the MC-4 parachute to ascertain the following:

- a. Log record/parachute inspection data pocket and form. As applicable, inspect the assembly log record parachute inspection data pocket to ensure the Army Parachute Log Record (DA Form 3912), NAVWPNCEN or NAVWPNS CL 13512/11(Parachute History Record) is enclosed and properly attached. Further, remove the log record from the pocket and evaluate the recorded entries. Inspect and evaluate as follows:

The Army Parachute Log Record, DA Form 3912, and AFTO 391 are history-type maintenance documents that accompany the parachute canopy and pack tray assemblies through the period of service of the individual assembly. The log record provides a means of recording maintenance actions performed on a parachute canopy assembly. Normally, a log record is initiated and attached to a right rear riser upon receipt by a using unit. However, if the item is subjected to alteration or modification by a maintenance activity during the interim period from date of manufacture to receipt by a using unit, the log record will be prepared by the activity performing the maintenance function. Once initiated, a log record will be attached to, and contained in, an affixed parachute log record/inspection data pocket, until such time as the parachute canopy assembly is destroyed or rendered unfit for further use or repair. Additionally, should an item that requires a log record, be transferred from one unit to another, the log record for the parachute assembly will accompany the item in the transfer action. A prepared log record will not be removed or separated from a parachute, and especially a packed parachute, except as directed by the local air delivery equipment maintenance activity officer. A log record that is illegible, lost, damaged, soiled, or precludes further entries due to lack of space, will be replaced upon the next repack or inspection, as applicable, with a serviceable item from stock.

- b. Assembly completeness. Ensure the applicable assembly is complete and that no components (or parts) are missing.
  - c. Operation adequacy. Check the item components and parts to ensure proper assembly, which includes attachment and alignment, and that the assembled product functions in the prescribed manner. Further, ensure that no stitch formation (or sewn seam) has been omitted.
  - d. Markings and stenciling. Inspect each assembly and components for faded, illegible, obliterated, or missing informational data and identification numbers.
  - e. Foreign material and stains. Inspect each assembly and related components for the presence of dirt or similar type foreign material. Also check for evidence of mildew, moisture, oil, grease, pitch, resin, or contamination by salt water.
2. Detailed inspection. In addition to the overall inspection performed in 1., above, a detailed inspection will be performed on the materials that constitute the assembly or component construction using the following criteria, as applicable:
    - a. Metal. Inspect for rust, corrosion, dents, bends, breaks, burrs, rough spots, sharp edges, wear, deterioration; damaged, loose or missing grommets, safety pins, connector snap, eye hook, pack fastener; improper swaging or welding; loss of spring tension; and missing or loose screws.
    - b. Cloth. Inspect for breaks, burns, cuts, frays, holes, rips, snags, tears; loose, missing, or broken stitching or tacking; and weak spots, wear, or deterioration.

- c. Fabric tape, webbing, and cordage. Inspect for breaks, burns, cuts, frays, holes, snags, tears, incorrect weaving, and sharp edges formed from searing; loose, missing, or broken stitching, tacking, whipping, and weaving; weak spots, wear, and deterioration.
- d. Pressure-sensitive (adhesive) tape. Inspect for burns, holes, cuts, tears, weak spots; and looseness and deterioration.
- e. Rubber and elastic. Inspect for burns, cuts, holes, tears, weak spots, loss of elasticity and deterioration.

**3-RING RELEASE/RISER INSPECTION**

The following inspection will be conducted to determine the serviceability of the 3-ring release risers throughout the parachute's service life. Perform inspection as follows:

1. Lay the riser to be inspected face up on a smooth flat surface. Flip the smallest metal ring (No. 3) up toward the top of the riser and then push down on it to firmly seat it in the webbing, securing it to the riser. The range of allowable relationships between the No. 3 ring and the grommet is illustrated below.
2. If the riser is serviceable up to this point, flip the No. 3 ring down toward the bottom of the riser. Push down the No. 2 and No. 3 rings (the next larger ring) to firmly seat them in the webbing, securing them to the riser. The range of allowable relationships between the No. 3 and No. 2 rings is illustrated below. The riser to be inspected must now be properly assembled to a harness to complete the inspection.

**CAUTION**

Repetitive use of the rings in the same position may cause elongation. This will prevent the rings from releasing.

3. Rotate the small and large ring and visually check for deformed rings.

**Locking Loop  
Removed For  
Clarity**

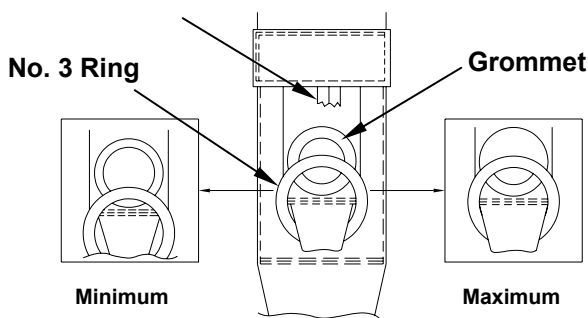

LOCATION OF NO. 3 RING AND GROMMETS

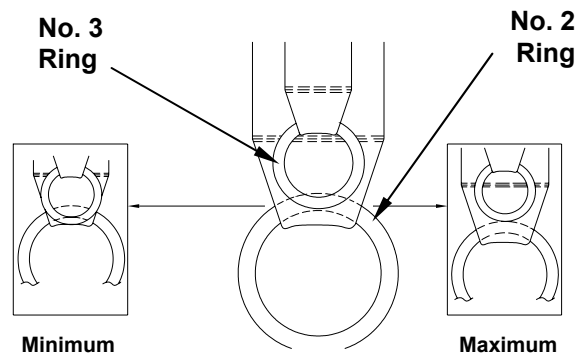

LOCATION OF NO. 3 AND NO. 2 RING

4. Look at the rear of the riser and with the weight (min 20-lbs) of the parachute rig (minus main parachute) suspended by the riser to be inspected, grasp the release cable housing by the swaged terminal end fitting with the small grommet in it and slide the end fitting to one edge (either edge) of the riser. You must NOT be able to move the fitting (do not use excessive force to move the fitting) completely off the edge of the riser (as depicted in the right illustration below), thus ensuring the fabric-locking loop is not too long. The length of the fabric locking loop should range as shown below.

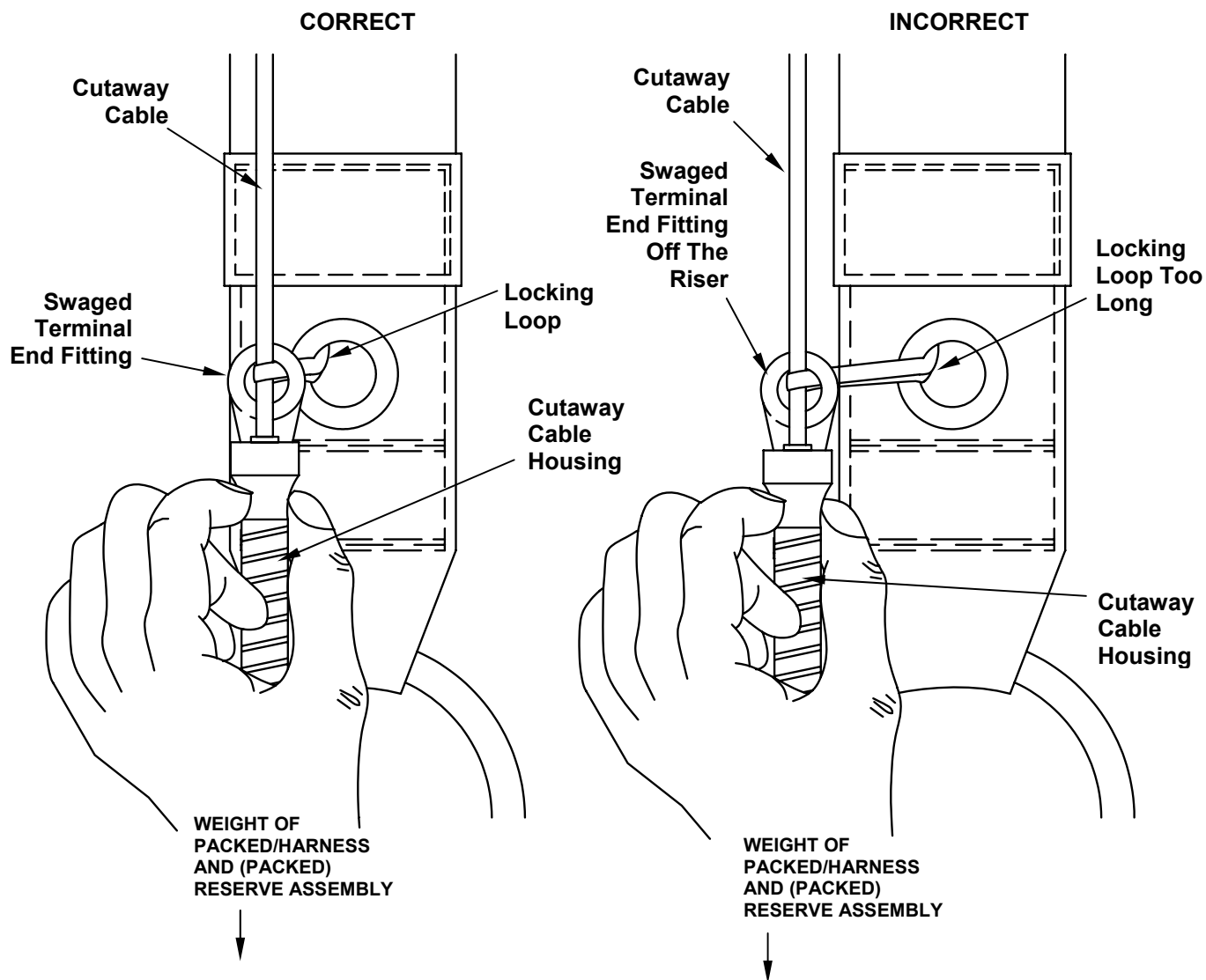

5. Periodic Maintenance Procedures. The three-ring release system is a durable item; however; it requires periodic maintenance and inspection to ensure proper operation. The 3-ring release will be carefully inspected and cycled (operated) on a regular basis. The procedures below will be completed every 120-days. This is especially important if the parachute system has not been used for 120-days or more (such as during the winter). Immediate inspection is required if the system has been subjected to abuse such as drug across the ground, a water landing, or exposure to a lot of dust or sand. Perform inspection as follows:

- a. Every 120 days operate the 3-ring release assembly on the ground by removing the cutaway handle. Extract the release cable completely from the housing and disconnect the risers.
- b. While the system is disassembled, closely inspect it for wear. Check the white locking loops (the ones that pass over the smallest ring and through the grommet) to be sure they are not frayed. Do not mix the risers with different material locking loops, i.e. nylon cord and nylon fabric locking loops. The locking loop may discolor (black) where it contacts the metal ring or grommets. This is permissible.
- c. Check the hook and pile fastener tape on the release handle and main lift web to ensure that it adequately holds the handle.
- d. Check the stitching, including that which holds the base ring to the main lift web and the hand tacking that prevents the release housing from sliding through the keeper (this keeper is located a few inches above the padded release handle).
- e. Take each riser and vigorously twist and flex the webbing where it passes through each ring. The idea is to remove any set or deformation in the webbing. Failure to do this might make the release hesitate when activated in response to a low drag malfunction such as a streamer.
- f. Check the inside of the release housing for gravel or other obstructions. Use cable to do this. Inspect the housing for dents or other damage.

**CAUTION**

Never lubricate the release cable with oil. Moisture only increases the probability of foreign material adhering to the release cable.

**CAUTION**

Ensure Clearslip #2™ silicone lubricant does not come in contact with any textile surface of the MC-4 RAPPS.

- g. Wipe the release cable with a clean, dry rag several times until all residue is removed. Ensure cable is clean. Apply a small amount of Clearslip #2™ silicone lubricant to another clean dry rag and wipe each cable several times. Allow a few moments for evaporation.
- h. Inspect the housing for dirt, dents, and debris. Any dents are cause for immediate grounding of the system until a replacement housing is installed.
- i. After repeated use, dents will appear in the cadmium plating. Rotate the rings periodically to reduce the localized plating damage.

**WARNING**

Do not allow the release assembly to become wet in cold weather. It may freeze, stiffen the webbing, and fail in use causing death or serious injury.

- j. Inspect each release housing and assembly. Check release assembly for rust. Any rust is cause for immediate grounding of the system until the hardware is replaced.
- k. Inspect all grommets. Grommets must not be bent, dented, loose or burred. Replace the riser if frayed webbing begins to show around the large No. 2 grommet.
- l. Properly reassemble the system ensuring it is done IAW this technical manual. To ensure the risers are not reversed, double-check them.

**SLACK CHECKER INSPECTION (AR2 Reserve Mounted ONLY)**

After every jump and repack of the reserve parachute, the parachute rigger is to inspect cable extension length with the slack checker as follows:

1. The MC-4 must have an AR2 and power cable assembly correctly installed and routed to the reserve parachute. Ensure that the position of the AR2 in the pocket is the same as when worn by a jumper.
2. Open top flap of parachute to expose the reserve ripcord pins.
3. Slide the metal head of the slack checker under the power cable from the right side so the cable slips into the curved groove between the metal head and plastic handle. Engage the two contact points on the hooked end of the slack checker with the mouth of the end fitting of the power cable housing. The slack checker should be held flat against the parachute pack. The two contact points must be engaged at all times to ensure proper inspection. (Refer to the illustration below).

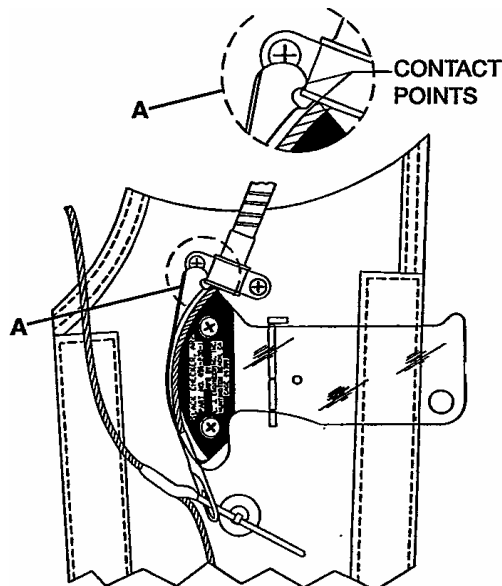

4. Grasp the slack checker with the right hand, palm down, and with the thumb pressed into the curved recess. Grasp the swaged section of the ripcord pin with left hand. Simultaneously rotate the slack checker and ripcord pin in the directions shown by the arrows. Hold the ripcord pin with the left hand in a fixed position when it becomes horizontally aligned. (Refer to the illustration below.)

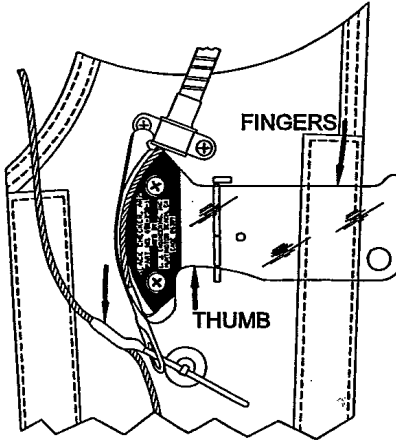

5. Apply force as necessary to rotate the slack checker until all of the slack in the power cable has been taken up. Ensure that the pin does not slip out of the closing loop of the parachute. Note the position of the swaged end of the power cable eye with respect to the index surface on the slack checker.
6. If the power cable assembly is correctly routed and installed, and has not been damaged, the end of the eye should not extend past the index surface. (Refer to the illustration below.)

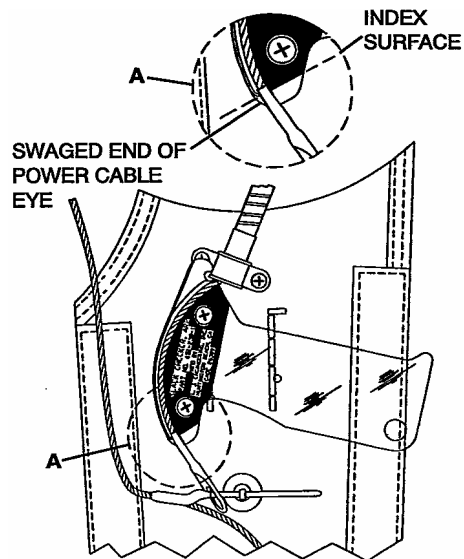

**WARNING**

Any amount of extension past the index surface may mean the ripcord pins will not be pulled, which may result in death of parachutist.

7. If the end of the eye does extend past the index surface, then something is wrong with the cable routing, or the power housing (conduit) may be damaged. The power cable assembly should be removed from service immediately. (Refer to the illustration below.)

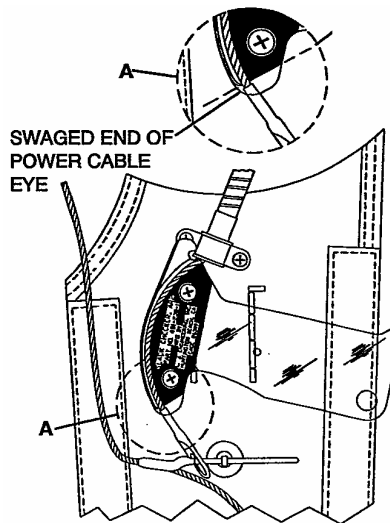

8. The rigger shall record satisfactory completion of inspection with the slack checker in the reserve parachute log record book (DA Form 3912). The slack checker test will be annotated in the JUMP, INSPECTION AND REPACK DATA section, in the area marked BAG NUMBER as follows: "SC Test PASS/FAIL".

### IN-STORAGE INSPECTION

An in-storage inspection is a physical check conducted on a random sample of air delivery equipment that is located in storage. The purpose of the inspection is to ensure that the equipment is ready for issue, that the item is properly identified and segregated from other types of equipment, that no damage or deterioration of equipment has been incurred, and that all modifications or similar action requirements have been completed.

The inspection shall also concern the methods and procedures applied to the storage of air delivery items, the adequacy of storage facilities, efforts of pest and rodent control, and protection against unfavorable climatic conditions. Air delivery equipment that is in storage will be inspected at least semiannually and at more frequent intervals if prescribed by the local parachute maintenance officer. The frequency of inspection may vary according to the type of storage facilities and local climatic conditions. Only parachute rigger personnel designated by the local parachute maintenance officer will conduct in-storage inspections.



**EQUIPMENT DISPOSITION**

Air delivery equipment may be rendered unserviceable by either normal fair wear or by aging, and will be subsequently be repaired, modified, or condemned, as appropriate. Equipment that is uneconomically repairable (outdated) will be condemned. Disposition of air delivery equipment that is condemned, unserviceable, or for which the serviceability is questionable, will be accomplished using the following procedures, as applicable:

1. Item requiring repair or modification. An air delivery item that requires repair or modification will be tagged in accordance with DA PAM 738-751. Subsequent work on the item will be performed at the maintenance level specified for the maintenance function in the applicable supporting technical publication.
2. Parachutes with exhausted age or service life. Any parachute component or air delivery equipment whose age or service life has expired as specified in TB 43-0002-43 will be removed from service, condemned and tagged as prescribed by DA PAM 738-751.
3. Disposition of condemned air deliver equipment. Condemned equipment, other than fatality parachutes, will be removed from service and disposed of in accordance with current directives listed in this WP.
4. Rejected equipment. Equipment which, prior to use, is deemed unserviceable for use will be reported in an EIR in accordance with DA PAM 750-8, as authorized by AR 750-1. Each applicable item that is defective will be held and safeguarded pending receipt of disposition instructions from the National Maintenance Point (NMP). In all instances, EIR exhibit material will be handled as prescribed in DA PAM 750-8. If the quality or the serviceability of an item is questionable, clarification and assistance may be obtained by contacting Commander, U.S. Army Tank-automotive & Armament Command, ATTN: AMSTA-LC-R, Kansas Street, Natick, MA 01760-5052.
5. Equipment of doubtful serviceability. Equipment that has had previous use and has not exceeded normal fair wear or aging criteria, but of which further serviceability is doubtful, will be tagged as prescribed in DA PAM 738-751. In addition, the equipment will be reported in an EIR, in accordance with DA PAM 750-8 and AR 750-1. The item(s) in question will be held as EIR exhibit material as outlined in DA PAM 750-8 pending receipt of disposition instructions from the NMP. A maintenance activity holding EIR exhibit material will not tamper with the applicable item(s) or make any attempt to ascertain cause factors. Unnecessary handling of EIR exhibit material may disturb or alter peculiar aspects of the affected item(s) that might affect the judgment of engineering personnel who have the responsibility for final evaluation of EIR actions.

6. Equipment immersed in salt-water. Any air delivery item constructed from cotton material that has been immersed in salt-water will be condemned. Cotton thread used for tacking and sewing on nylon parachute packs that have been immersed in salt-water will only be replaced when there is visible evidence or deterioration such as extreme discoloration or indications of broken thread. Any air delivery equipment constructed of nylon or rayon material that has been immersed in salt-water for a period less than 24-hours, but which cannot be rinsed within 48-hours after recovery will also be condemned, unless the following actions are performed. Upon removal from the salt water, the parachute is placed in a single heavy-duty plastic trash bag, the top of the bag secured closed and kept in a wet state until a rinse can be performed following normal rinse procedures. The bag must be doubled when outside temperatures exceed 85 degrees F. The bags must be inspected after transport and storage to ensure the bag did not get torn and the assembly was allowed to dry. Parachutes recovered using this method must be rinsed NLT than seven (7) days after the salt-water immersion or be condemned. However, if the cited time limitations can be met, then immediately upon recovery, suspend or elevate the recovered equipment in a shaded area and allow the item(s) to drain for at least 5-minutes. Do not attempt to wring the equipment fabric or the suspension lines. Within 48-hours after recovery, under the supervision of a qualified parachute rigger (92R), rinse the recovered equipment as indicated in WP 0012 00.

**END OF WORK PACKAGE**

---

**MC-4 RAM AIR FREE-FALL PERSONNEL PARACHUTE SYSTEM  
SALT/FRESH-WATER CONTAMINATION TEST**

---

**THIS TASK COVERS:**

- Inspect
- 

**INITIAL SETUP:****Equipment Condition**

Laid out on packing table or other suitable area.

**Personnel Required**

92R(10) Parachute Rigger

**INSPECT**

Look for a white crystalline residue. If evidence of salt-water/fresh-water contamination is found, refer to the procedures detailed below:

**Rinsing Parachute Assembly Immersed in Salt-Water.** If the parachute, or any of its components, has been immersed in salt water in excess of 24-hours it will be condemned. Additionally, if the parachute, or any of its components, has been immersed in salt-water for a period less than 24-hours, but which cannot be rinsed within 48-hours after recovery, it will also be condemned, unless the following actions are performed. Upon removal from the salt-water, the parachute is placed in a single heavy-duty plastic trash bag, the top of the bag secured closed and kept in a wet state until a rinse can be performed following normal rinse procedures. The bag must be doubled when outside temperatures exceed 85 degrees F. The bags must be inspected after transport and storage to ensure the bag did not get torn and the assembly was allowed to dry. Parachutes recovered using this method must be rinsed NLT than seven (7) days after the salt-water immersion or be condemned. However, if the cited time limitations can be met, then immediately upon recover, suspend or elevate the parachute assembly in a shaded area and allow it to drain for at least 5-minutes. Do not attempt to wring the fabric or the suspension lines. Within 48-hours after recover, under the supervision of a qualified parachute rigger (92R), rinse the recovered parachute assembly as follows:

1. Place the parachute assembly in a large watertight container filled with a suitable amount of fresh, clean water to cover the assembly.

---

**CAUTION**

---

Equipment made of cotton fabric immersed in salt water is to be condemned. Refer to WP 0011 00, INSPECTION, for equipment disposition.

---

**NOTE**

---

If the salt-water-soaked parachute assembly is too large to be placed into a rinsing container, then the rinsing process will be affected by applying fresh, clean water to the assembly using a hose.

2. Agitate the container contents by hand for 5-minutes.
3. Remove the parachute assembly from the container and suspend or elevate it in a shaded area, allowing a 5-minute drainage period. Do not attempt to wring the fabric or the suspension lines.

4. Repeat the procedures in steps 1. through 3., above, twice, using fresh, clean water for each rinse.
5. After the third rinse, allow the parachute assembly to drain thoroughly. Upon completion of draining, dry the assembly in accordance with the Drying Fabric Items procedures detailed below.
6. When dried, perform a technical/rigger-type inspection of the parachute assembly. Corroded metal components, or corrosion-stained fabrics or suspension lines, will be either repaired or replaced as prescribed by the Maintenance Allocation Chart (MAC) in WP 0063 00.
7. Record any repair, immersion, and rinsing in the parachute log record as shown in WP 0004 00.

**Rinsing Parachute Assembly Immersed in Fresh-Water.** Any parachute, or its components, that has been immersed in a fresh water lake, river, or stream will not require rinsing unless it has been ascertained that the water is dirty, oily, or otherwise contaminated. Procedures for handling a fresh water immersed parachute are as follows:

1. Contaminated fresh-water. If the parachute, or its components, has been immersed in contaminated fresh water, rinse and dry (see Rinsing Parachute Assembly Immersed in Salt-Water, above), and, if applicable, repair.
2. Uncontaminated fresh-water. If the parachute, or its components, has been immersed in uncontaminated fresh water, it will be cleaned and dried as outlined in Cleaning Fabric Items With a Solution of Hand Dishwashing Compound, Drying Fabric Items, and Cleaning Metal Items, in the detailed paragraphs above and below. Minor discoloration of fabric items, resulting from immersion in uncontaminated fresh water, may occur.

NOTE

Fabric items will not be dried in direct sunlight or by laying an item on the ground.

**Drying Fabric Items.** Dry fabric items as follows:

1. Suspend or elevate the item in a well-ventilated room or in a heated drying room.
2. Using electric circulating fans may reduce drying time.
3. When heat is used, the heat temperature shall not exceed 160 degrees Fahrenheit (71 degrees Celsius). The preferred temperature is 140 degrees Fahrenheit (60 degrees Celsius).

**END OF WORK PACKAGE**

---

**MC-4 RAM AIR FREE-FALL PERSONNEL PARACHUTE SYSTEM  
PACKING PROCEDURES – RESERVE PARACHUTE**

---

**This Task Covers:**

- Pack-In-Process Inspection
  - Layout and Line Check
  - Flaking Canopy
  - Folding Canopy
  - Stowing Canopy and Suspension Lines
  - Closing Container
  - Stoke Simulator Test
  - Attachment of the AR2
- 

**INITIAL SETUP:****Tools**

Pins, Temporary Locking (Item 31, WP 0063 00)  
Stroke Simulator (Item 41, WP 0063 00)

**Personnel Required**

92R (10) Parachute Rigger  
92R (20) Parachute Rigger

**Equipment Condition**

Lay reserve canopy and suspension lines out to their full length in packing area.

**Materials/Parts**

Band, Rubber Retainer (Item 4, WP 0076 00)  
Cord, Nylon, Type III (Item 13, WP 0076 00)  
Thread, Cotton, 24/4 (Item 40, WP 0076 00)

---



---

**WARNING**

---

Failure to detect areas of damage during packing, or failure to comply with the following procedures, may result in a malfunction of the parachute and injury or loss of life to personnel.

---

**WARNING**

---

The reserve parachute-closing loop will be replaced at each reserve parachute repack cycle (120-days). Failure to comply may result in a malfunction of the parachute and injury, or loss of life, to personnel.

---

**NOTE**

---

The parachute will be packed every 120-days.

---

**NOTE**

---

The power cable length of travel must be checked each time a power cable is installed on the harness/container, at reserve parachute re-pack, when an AR2 has actuated during a jump, and whenever the parachute system has been subjected to unusual stress during landing.

**NOTE**

Inspect reserve parachute deployment bag, bridle, pilot parachute, and safety stow loop for damage.

**NOTE**

Remove reserve parachute ripcord handle and clean both the ripcord handle and ripcord handle pocket. Re-install reserve parachute ripcord handle.

**PACK-IN PROCESS INSPECTION**

A rigger supervisor other than the packer during the applicable packing process shall conduct the pack-in-process inspection. This inspection is required to ensure that only authorized packing procedures are used. The prescribed intervals to conduct the pack-in-process inspection are as follows:

1. Proper Layout
  - a. Proper installation and serviceability of AR2 power cable
  - b. Line Check
  - c. Canopy flaking completed
2. Slider Up
  - a. Canopy S-folding complete
  - b. Deployment brakes set and tacked
  - c. Tail folding complete
  - d. Slider pulled up and positioned
3. Canopy Folding Complete – Nose Fold
4. Suspension Lines Stowed
  - a. Locking stows complete
  - b. Suspension lines stowed
5. Bridle Needle Fold Completed
6. Container Side Flaps Closed
  - a. Bottom
  - b. Right
  - c. Left
7. Packing Completed
  - a. Ripcord routed through static line pull ring and guide ring
  - b. Top flap closed
  - c. All Packing aids removed
8. Automatic Opening Device Installed
  - a. Slack checker test complete (AR2)
  - b. Stroke simulator test complete (AR2)
  - c. Log record book filled out

**LAYOUT AND LINE CHECK**

Perform layout and line check as follows:

1. Insert reserve ripcord cable through reserve ripcord housing. Insert reserve ripcord grip into ripcord grip pocket. If removed, clean and lubricate single point release cable IAW WP 0011 00. Insert single point release cable through cable housings. Mate hook tape on grip with pile tape on harness. Attach reserve static line to container with reserve static line pull ring facing top of container. Pass reserve ripcord cable through reserve static line pull ring and then through reserve static line guide ring.

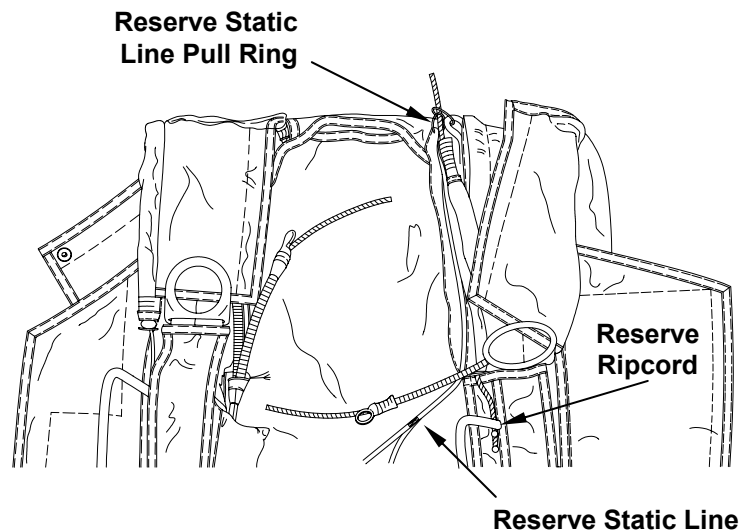

2. Lay out parachute on a clean dry surface with canopy on its left side. Leading edge (nose) will be to the right when viewed from riser end. Stretch lines full length with a helper at riser end to check continuity and hold lines taut.
3. Grasp high points of each cell and, with high points in the left hand, flip canopy toward trailing edge. Canopy shall lie flat with trailing edge lines on left side when viewed from riser end.

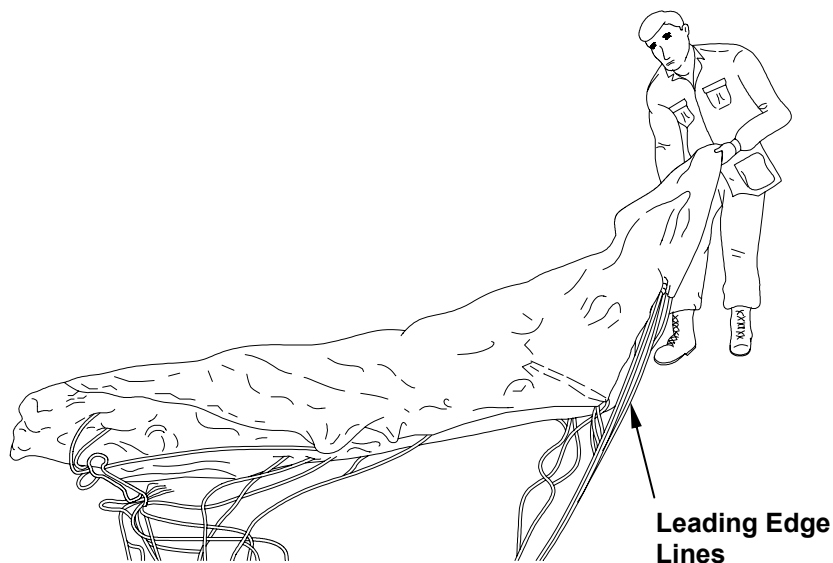

4. Remove any twists, turns, and tangles between suspension line groups.
5. Raise lines 8A and 8B and walk them down (ensuring there are no twists) to see if line 8A runs free from canopy to outside of right front riser connector link. Line 1A should run free to outside of left front riser connector link.

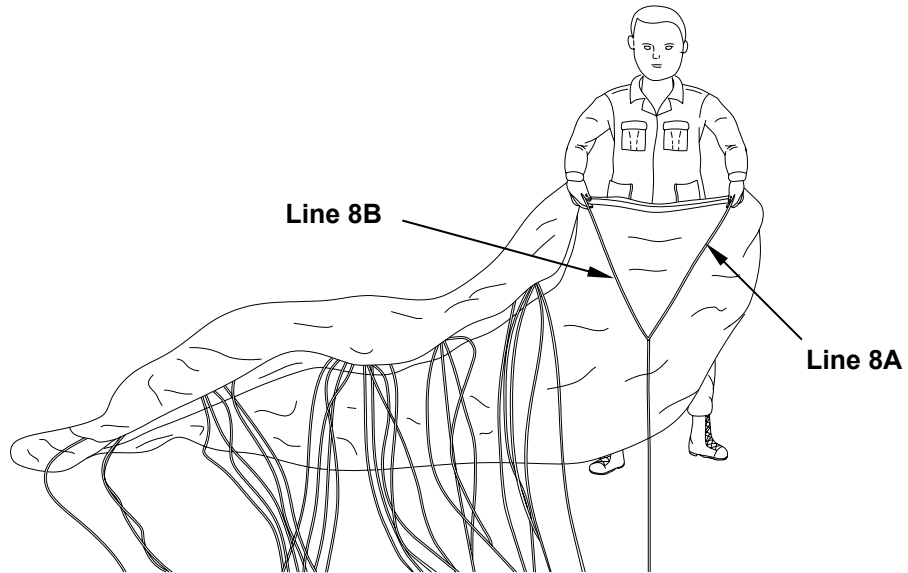

6. Raise lines 8C and 8D and walk them down (ensuring there are no twists) to see if line 8C runs free from canopy to outside of right rear connector link. Line 1C should run free to outside of left rear connector link.

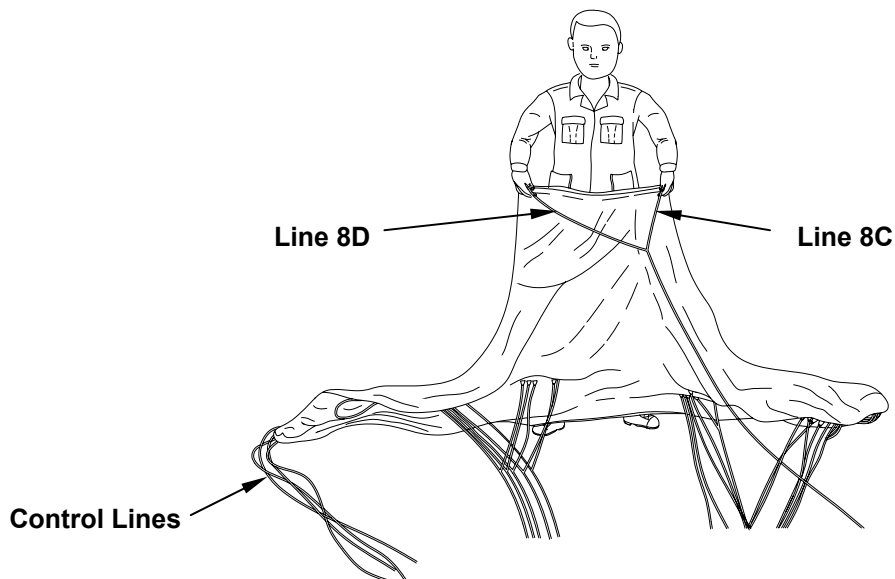



7. Raise control lines and walk them down (ensuring there are no twists) to ensure they run free from the A, B, C, and D lines.

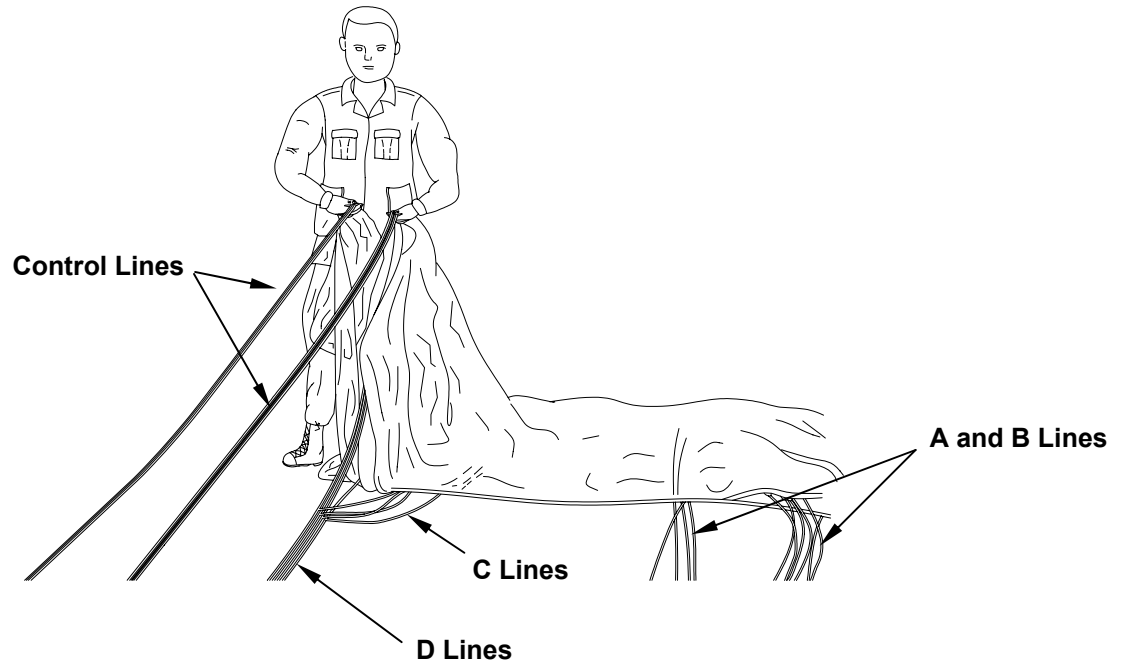

8. Ensure control lines run free through proper slider grommets, and then through proper control line guide ring.

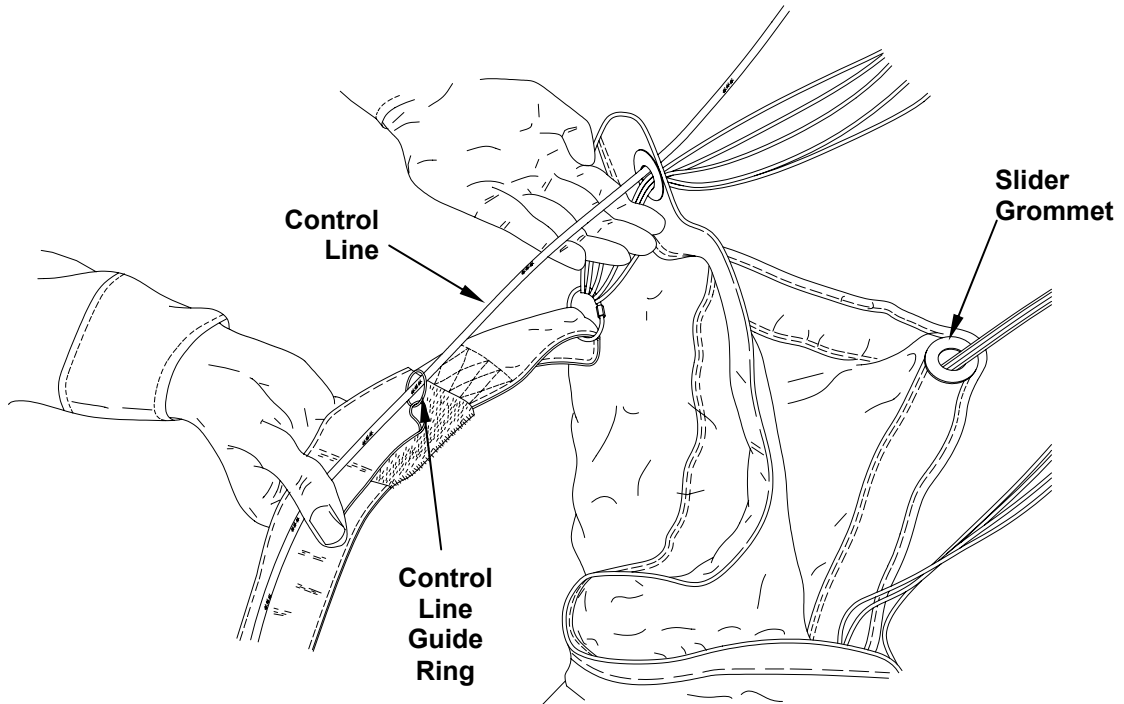

**FLAKING CANOPY**

Flake canopy as follows:

1. Grasping tops of cells at high points, throw canopy toward risers.



2. Starting with high points on cell 1, pull out seam and smooth cell from leading edge to trailing edge.



- Continue to flake canopy by pulling out seams one by one on each remaining cell. Smooth each cell until all cells are flaked and all line groups are clearly separated and tight.

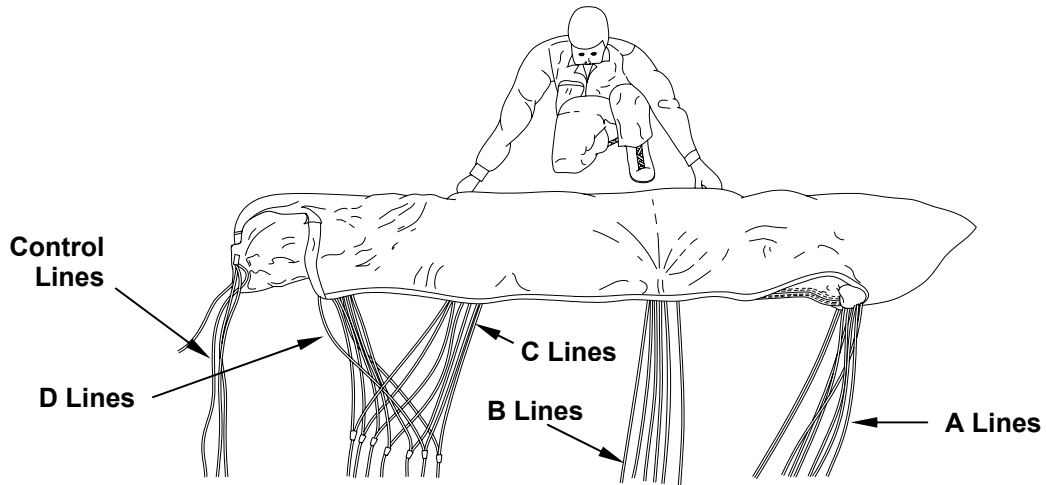

- Rigger check number 1.

**FOLDING CANOPY**

Fold canopy as follows:

- Fold leading edge over canopy so cell openings are even with A lines. Keep lines taut.

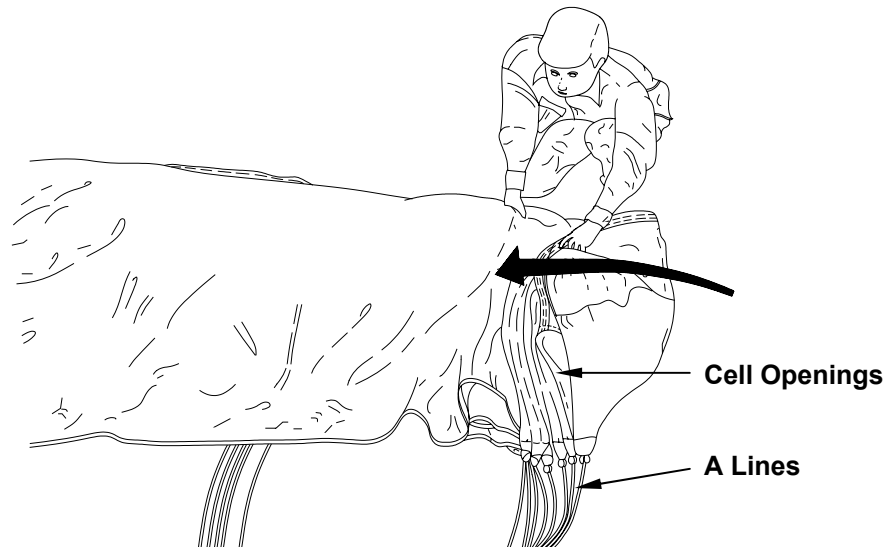

2. Grasp the high point of cell 1 and extend outward, smoothing out cell.

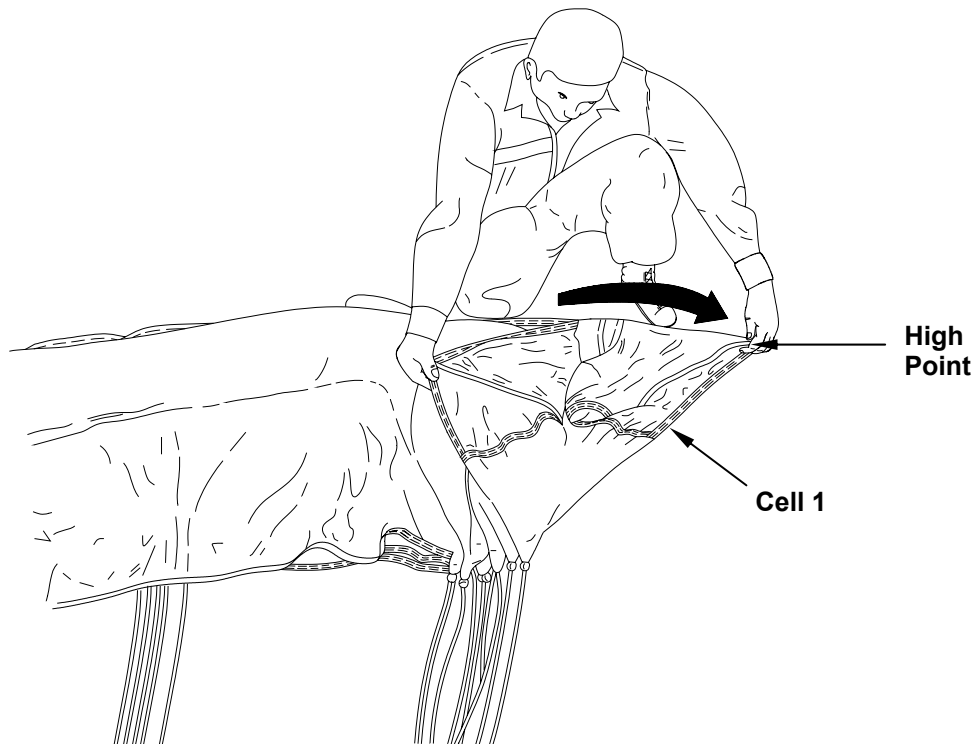

3. Continue to grasp high point of each cell and extend outward, smoothing out each cell and aligning all seven cell openings.
4. Make a fold in line with the A line group and fold canopy nose under.

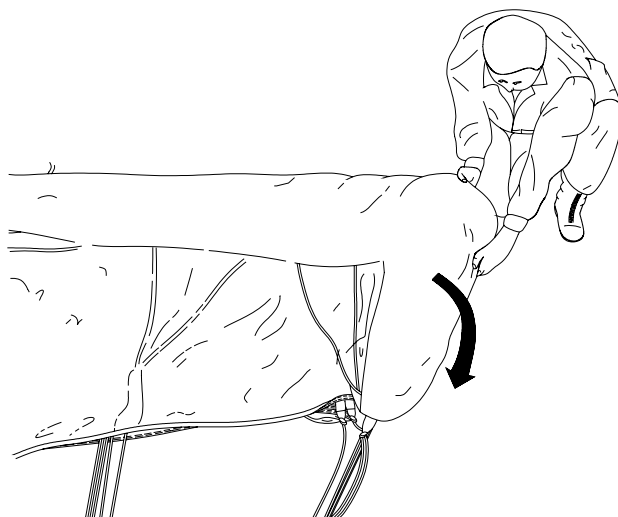

5. Holding all high points together directly in line with the B line group, make an S-fold so that the B line group is on top of the A line group. Ensure high points are kept taut.

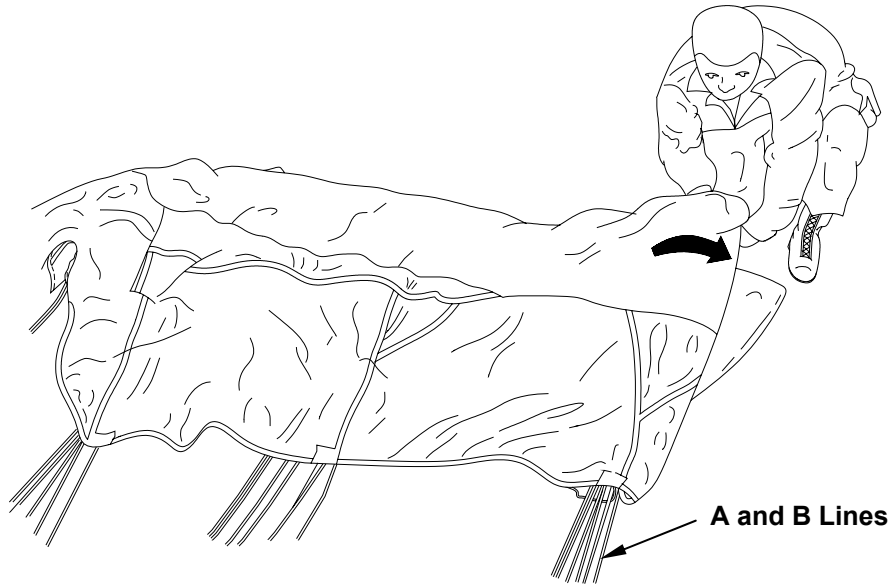

6. Holding all the high points together directly in line with the C line group, make an S-fold so that the C line group is on top of the A and B line groups. Ensure high points are kept taut.

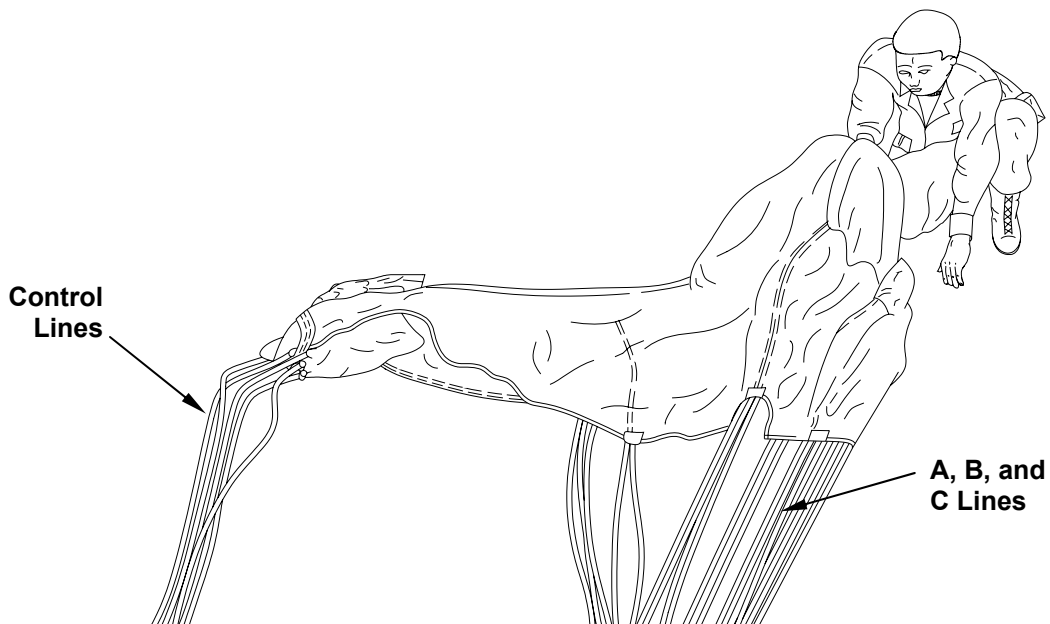

7. Holding all of the high points together directly in line with the D line group, make an S-fold so that the D line group is on top of the A, B, and C line groups. Ensure high points are kept taut.

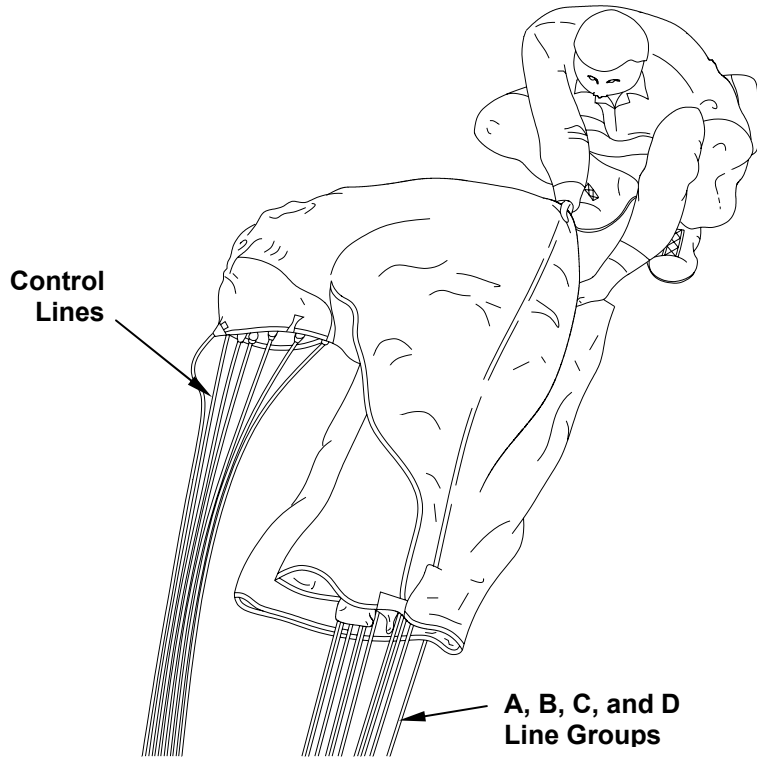

8. Clear the stabilizers by pulling them to the outside. Make sure that there are no lines wrapped around them. There are three stabilizer panels on each side.

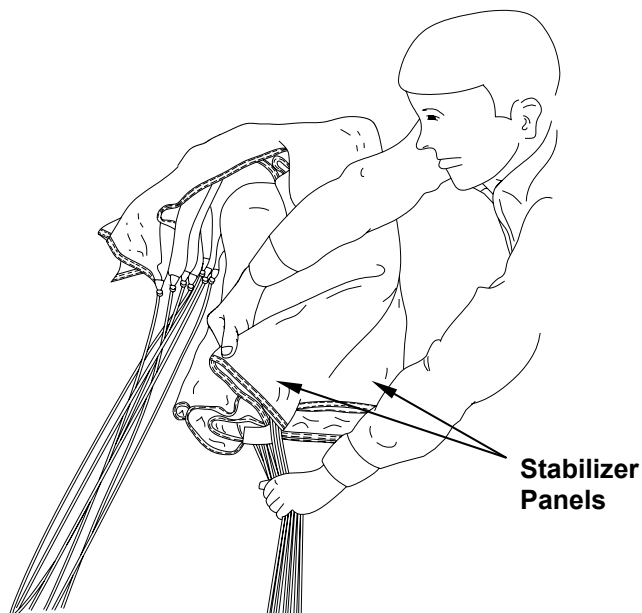

- Set deployment breaks by opening excess line keeper on each rear riser and then pulling down on each toggle until each finger-trapped loop is through each control line guide ring.

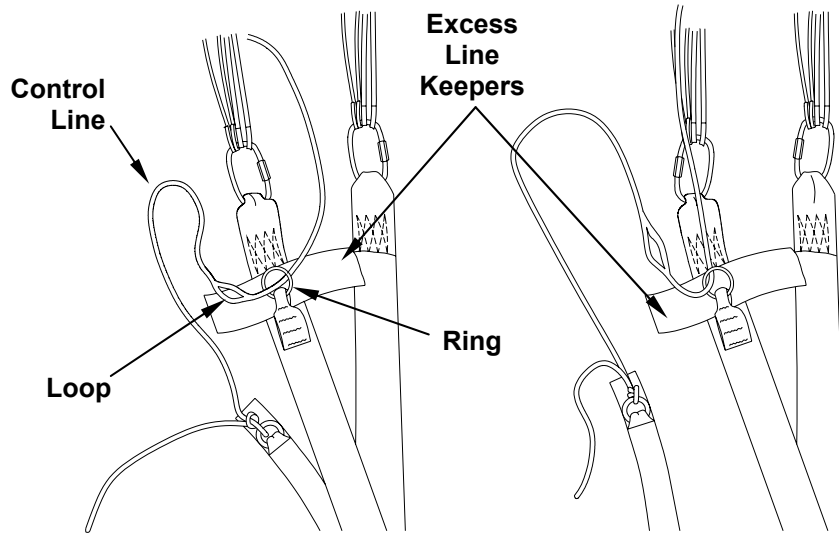

- Insert stiffened top of each control line toggle through 1-inch loop. Safety tack top center of control toggle to center of riser with one turn double of 24/4 cotton thread, encircling the control line. Tie off each tacking with a surgeon's knot and a locking knot. Trim ends to 1/4-inch. Ensure each loop with a stiffened end of toggle is seated firmly against ring on riser.

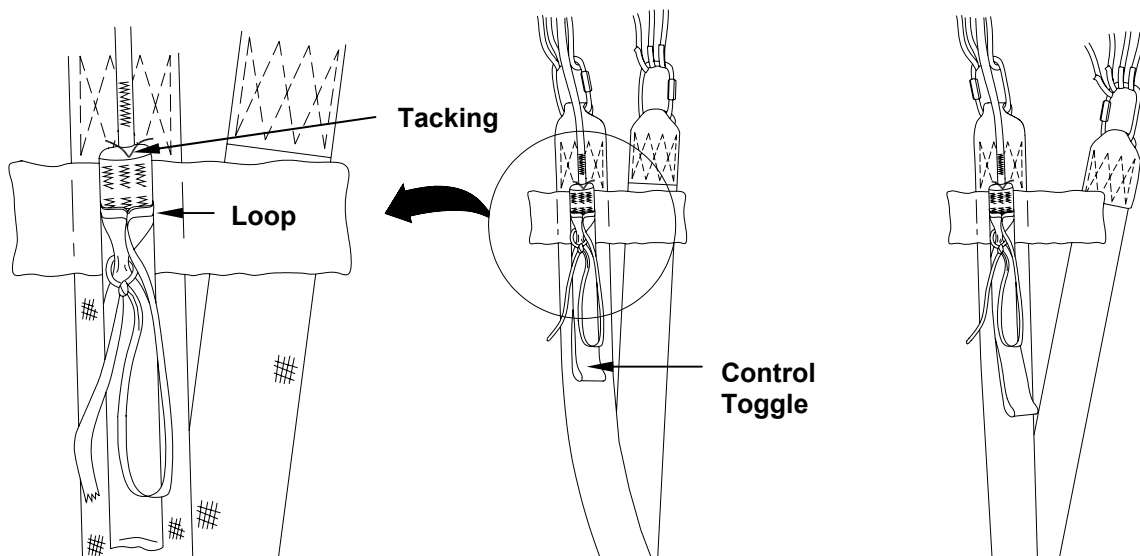

11. Using an S-fold, neatly stow excess line in excess line keeper alongside control line guide ring. Ensure that S-fold loops do not extend above or below excess line keeper. Ensure that excess line is to right (pile) side of keeper.

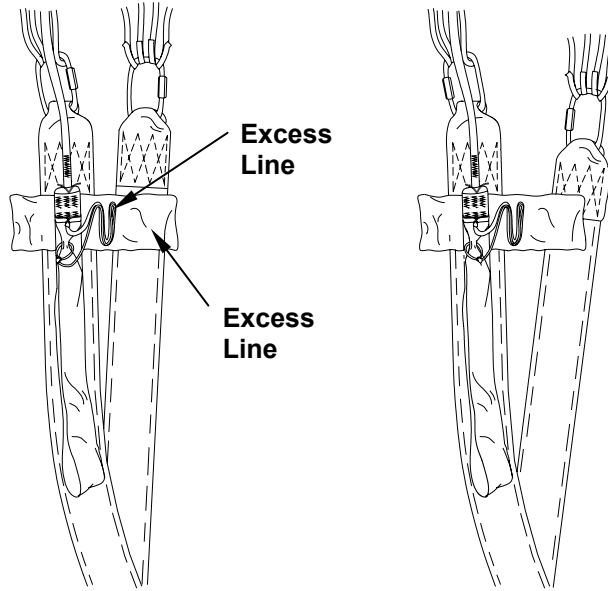

12. Close excess line keepers.

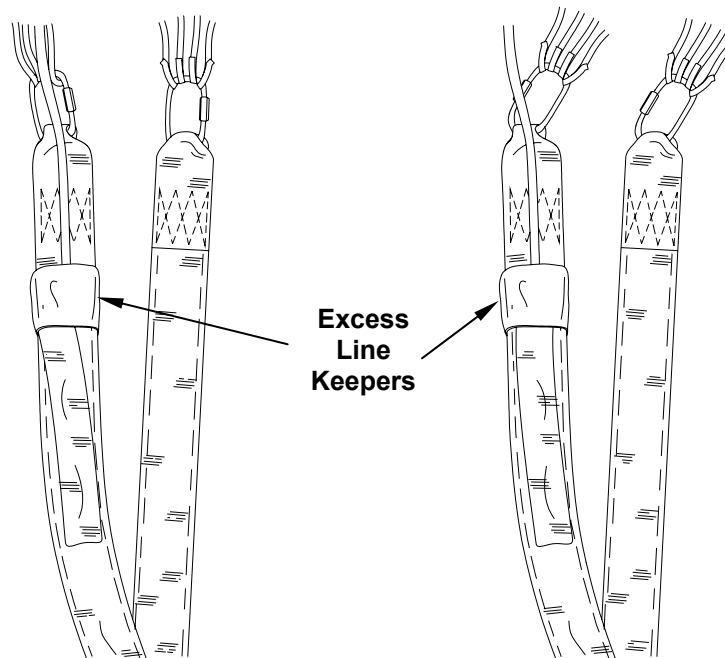



13. Grasp uppermost control line and pull taut. Position seam on folded canopy so control line is on top of line groups A, B, C, and D.

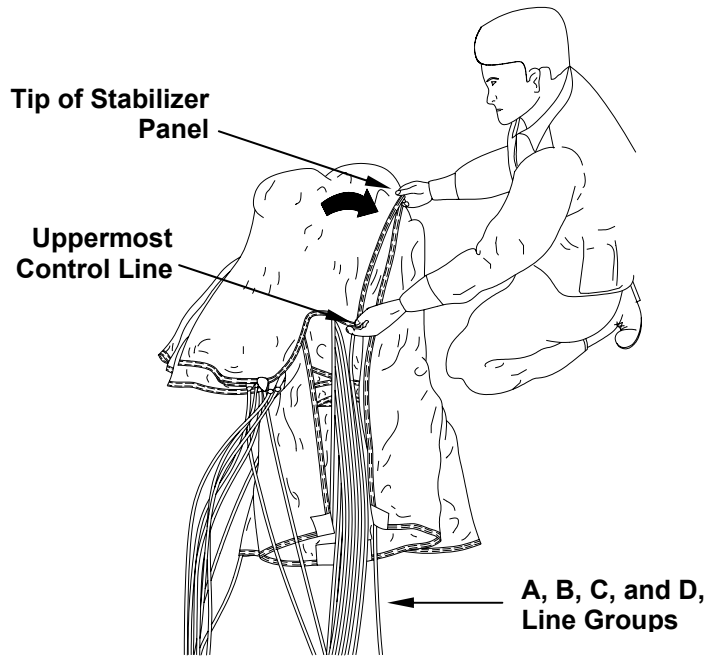

14. Continue to flake and smooth remaining tail seams. Lines should remain taut throughout the procedure.

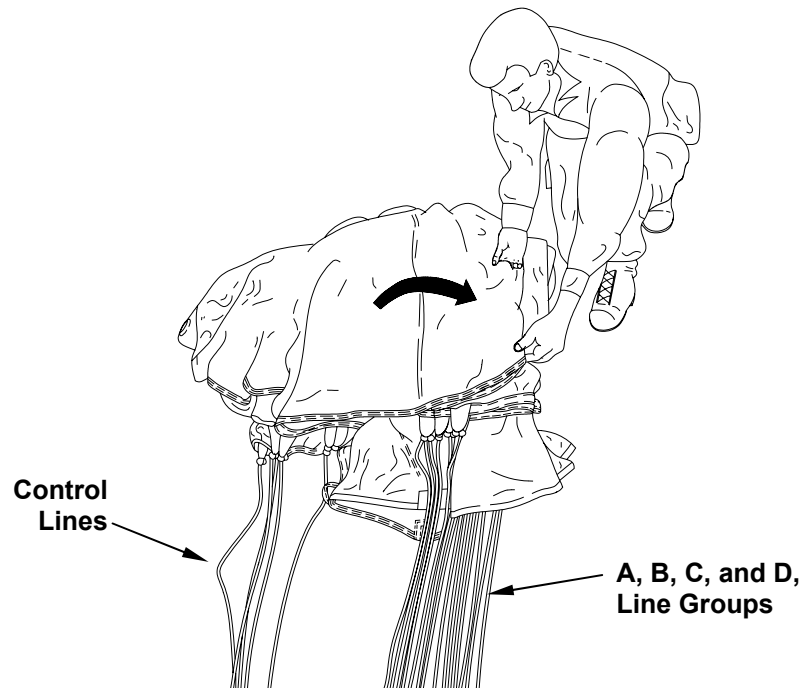

15. When canopy is flaked, all control lines should be on top of line groups A, B, C, and D. Ensure that bottom tail seam remains even with control lines.

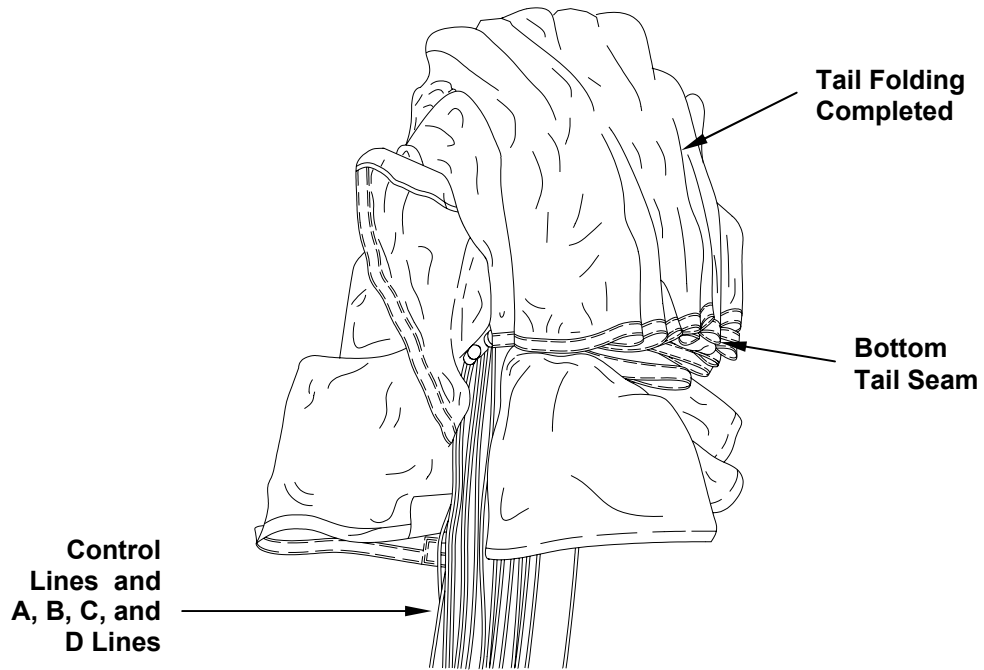

16. Grasping the top tail fold, count and fold back seven tail folds towards trail edge of canopy. Tail of canopy should now be on top of folded canopy with seven folds on left and seven folds on right. Control lines should remain taut and in the center.

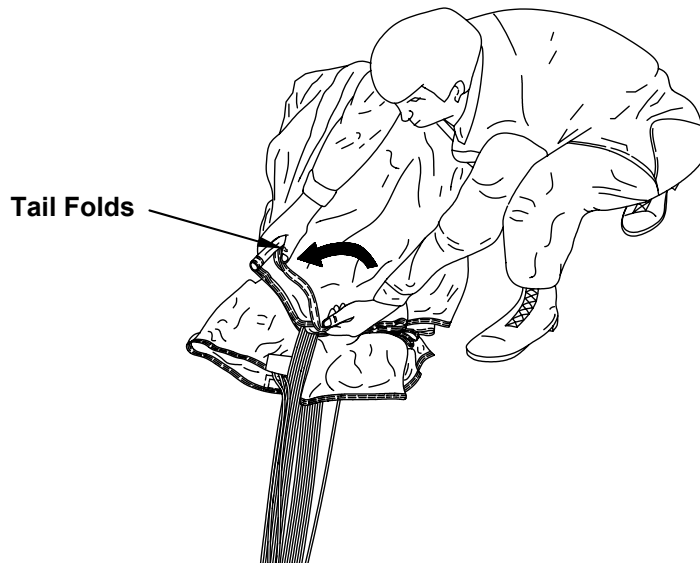

**NOTE**

Count all lines. Ensure you have 10 lines for the tail, 8 A and B lines and 8 C and D lines.

17. Kneel on canopy at suspension line end. Spread center of tail one full section left and right of center of tail.

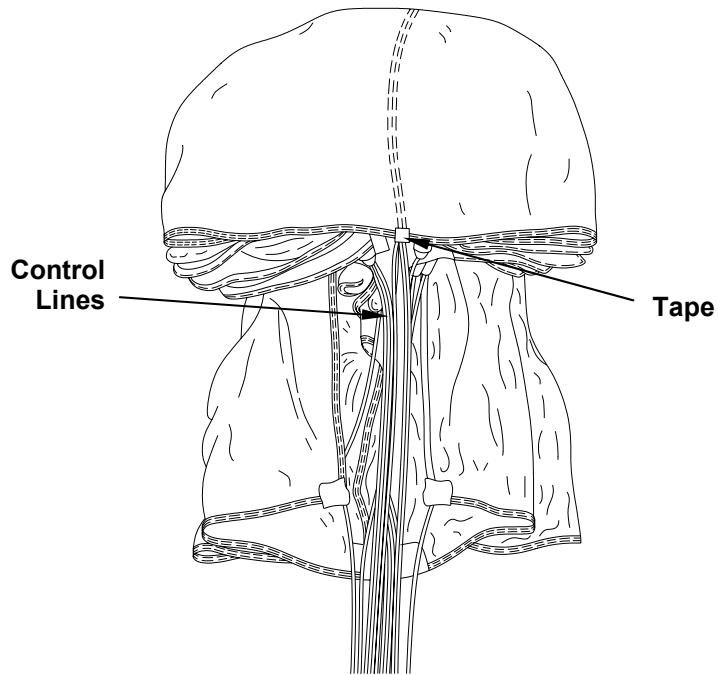

18. Wrap center tail panel around canopy, keeping control lines in center. Fold center tail panel around canopy until it is the width of deployment bag. Smooth out trapped air until canopy lies flat.

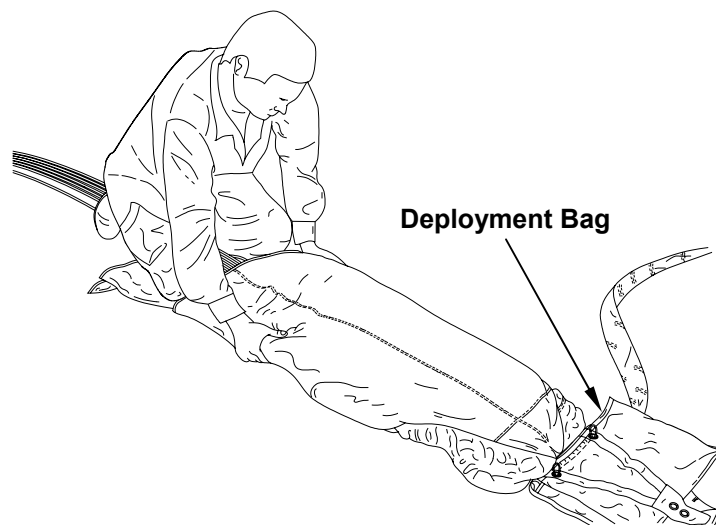

19. Place rear riser line groups to the outside of front riser line groups. Lay slider down flat between the line groups, with reinforcement tapes facing up. Each line group from the canopy enters slider grommet from the top and exits out underneath slider.
20. Grasp slider by top center, ensuring that the reinforcement tapes appear on top side toward canopy. Bring slider up to the bottom of the canopy, forming four distinct line groups. Ensure free movement along suspension lines.

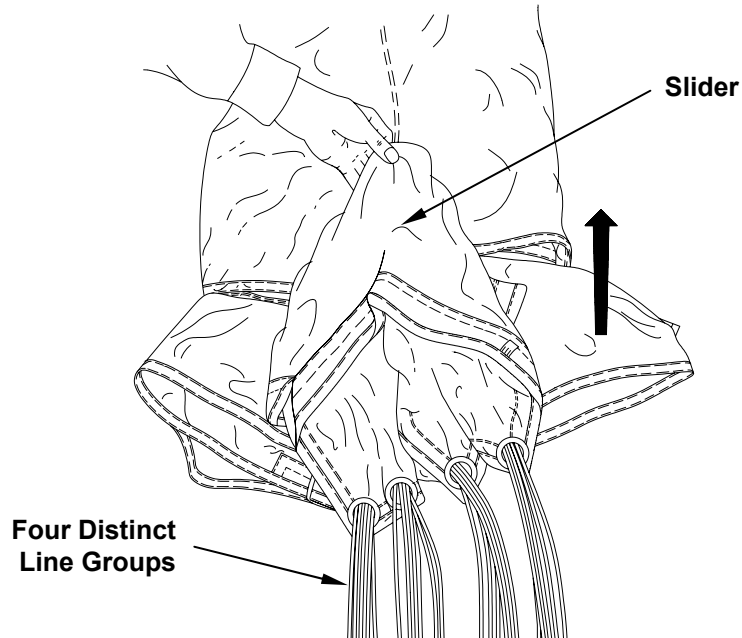

21. Rigger check number 2.
22. Fold left stabilizer panels, then right stabilizer panels on slider at 45-degree angles.

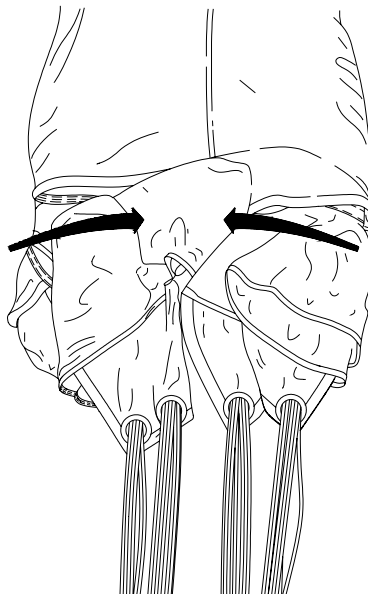

23. Place hand on canopy approximately 10-inches from suspension lines. Grasp canopy at suspension lines in preparation for making the first fold.

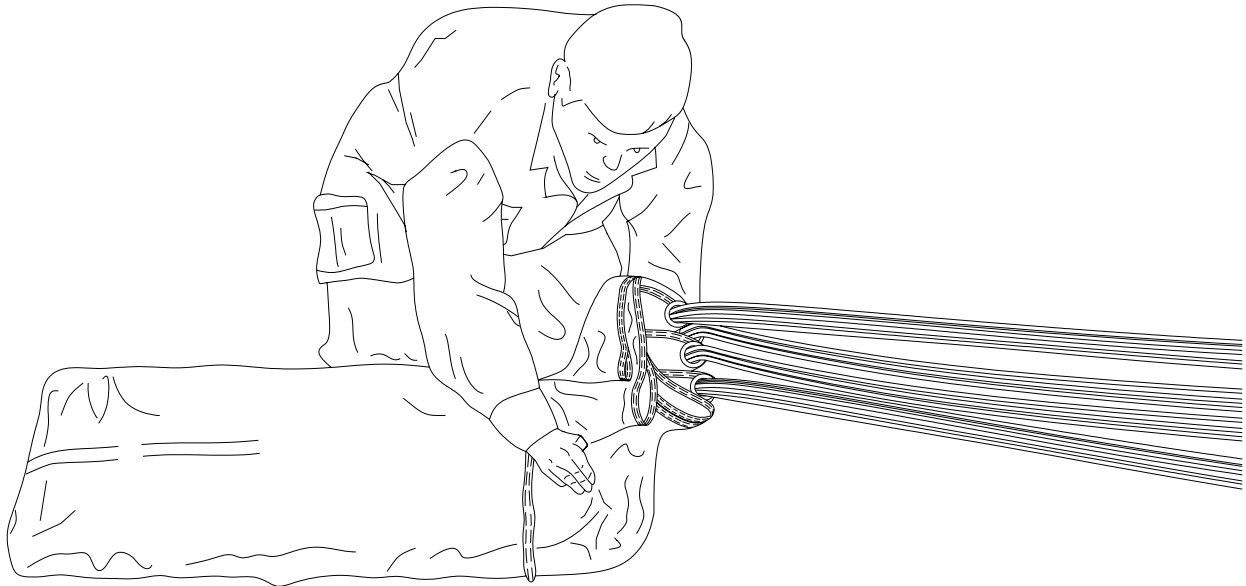

24. S-fold bottom of canopy approximately 10-inches so that slider grommets are on top of canopy. Ensure all suspension lines remain taut.

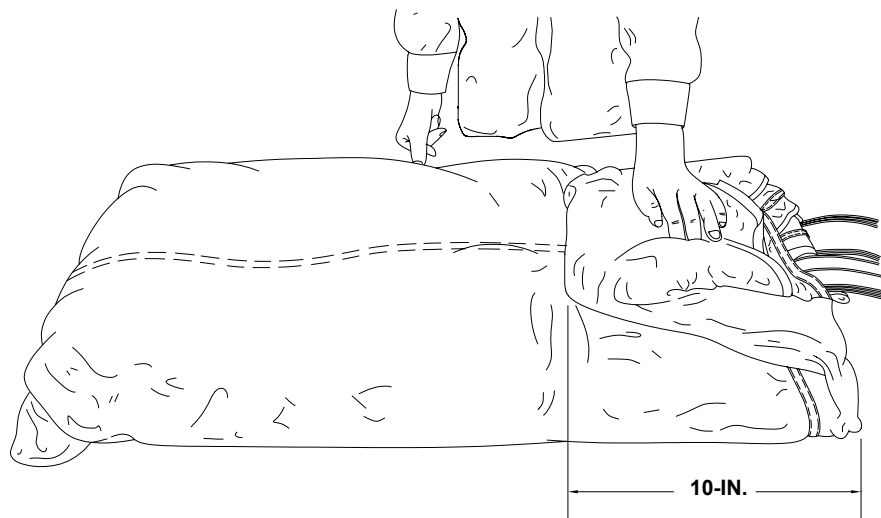

25. Pull center of tail section up and over S-fold so that it is positioned over slider and stabilizers. Dress the canopy.

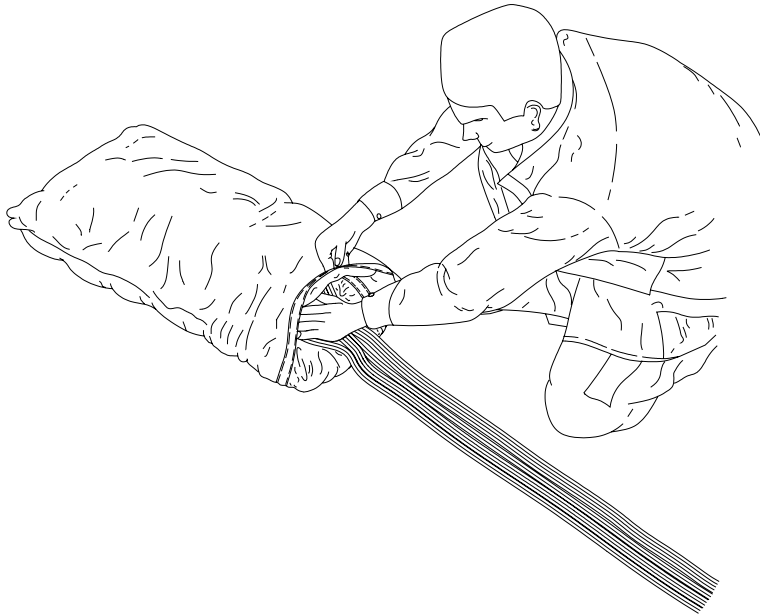

26. Place left hand one deployment bag length up from base of canopy. Grasp upper portion with the right hand. Fold upper canopy over lower canopy.

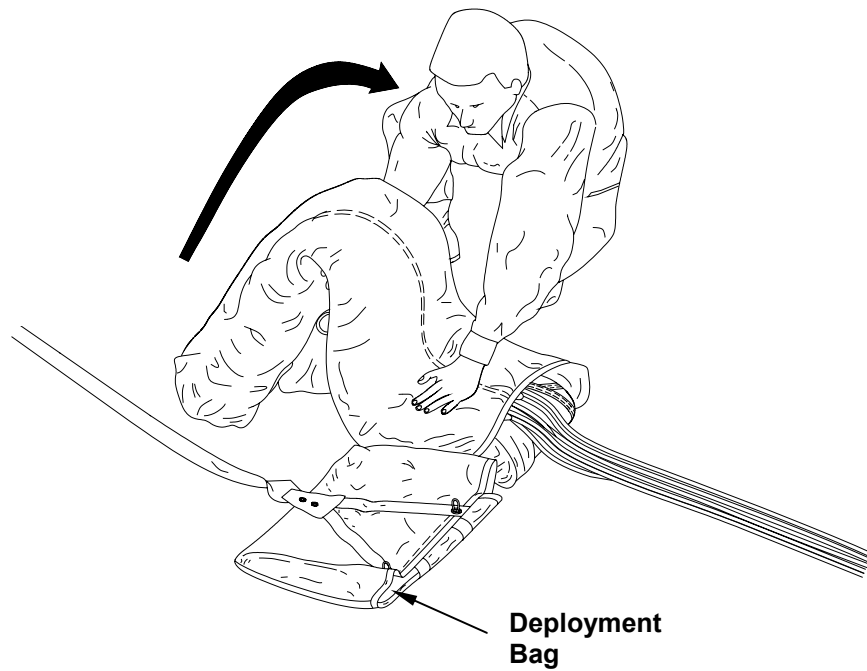

27. Locate the seven high points of the nose. Ensure each cell opening is completely exposed. Place three cell openings on each side with center cell split.

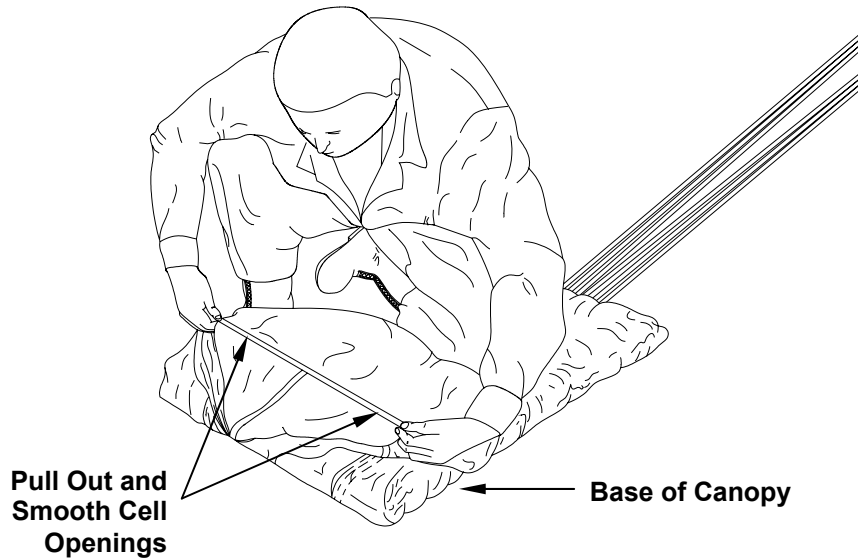

28. Rigger check number 3.

29. Fold the top portion of canopy over approximately 10-inches. This fold should be even with base of canopy.

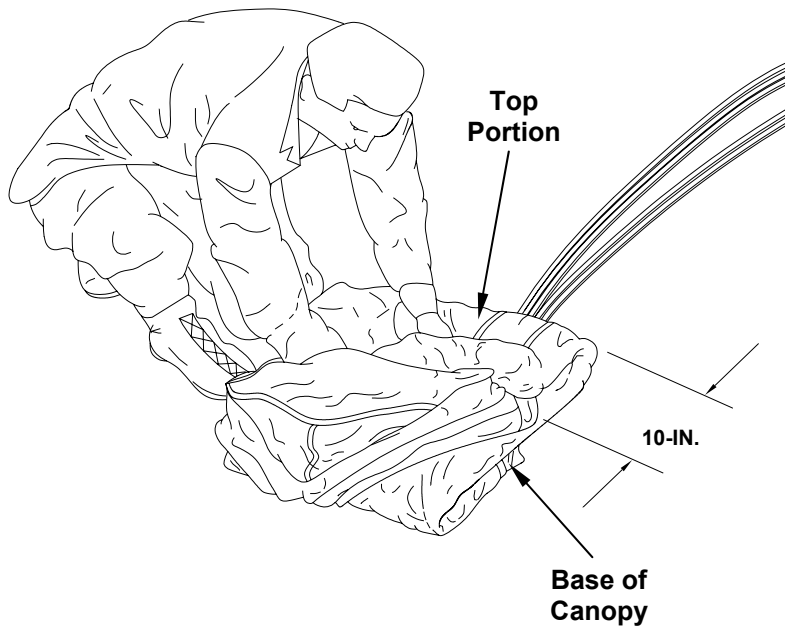

30. Roll the top fold toward nose of canopy an additional 10-inches. Position deployment bag over one corner.

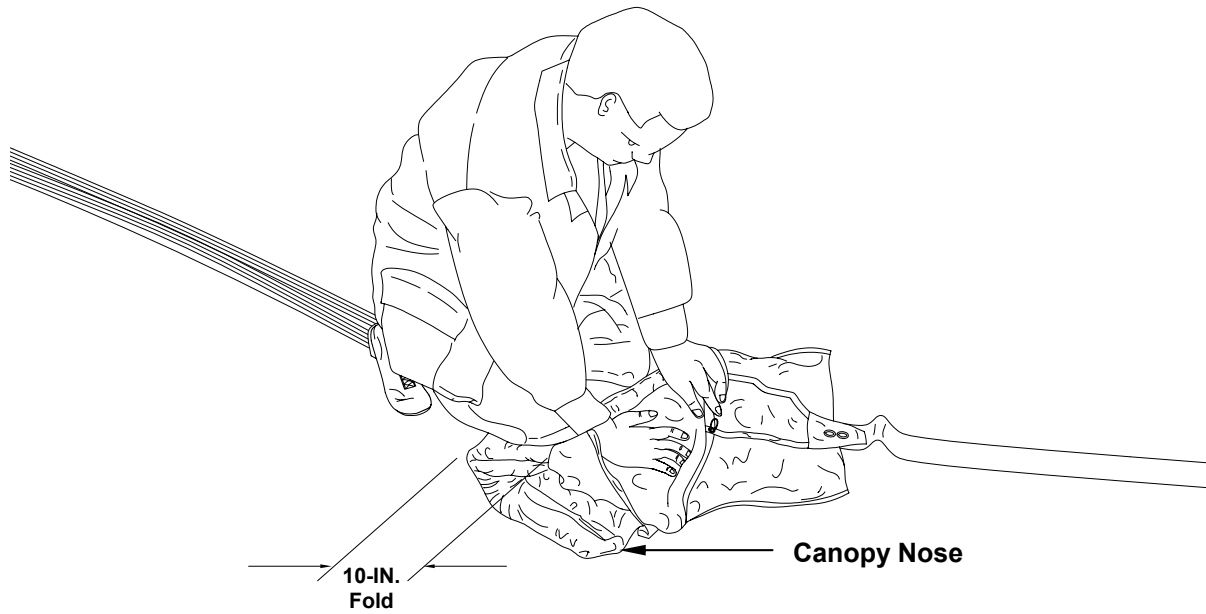

31. Insert folded canopy into deployment bag. Work canopy into corners and fill outside edges of bag. Insert deployment bag bridle through left elastic loop.

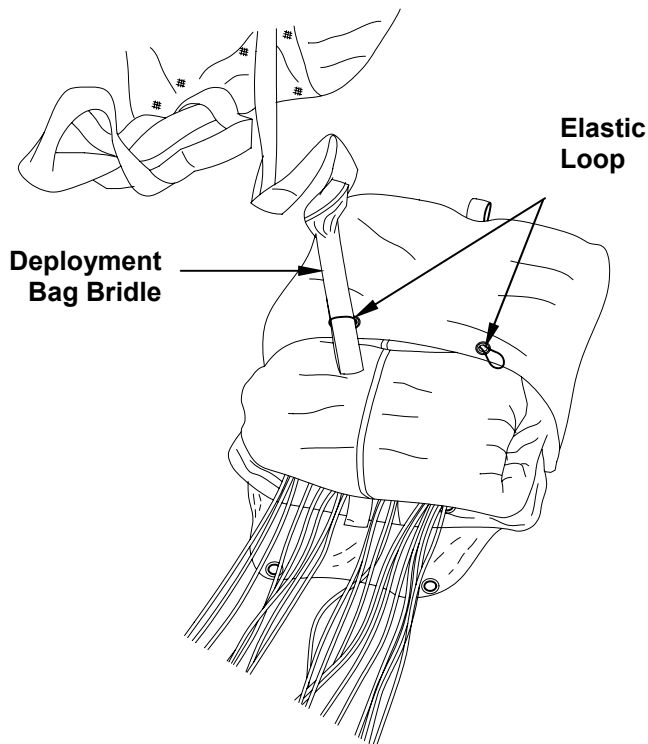



**STOW CANOPY AND SUSPENSION LINES**

Stow canopy and suspension lines as follows:

**NOTE**

Ensure slider grommets are not exposed past the tail of the base of the fold.

1. Make first locking stow on the right by pulling elastic loop through right grommet and locking in place with first suspension line stow. Stow will not protrude more than 1 <sup>3</sup>/<sub>4</sub>-inch through elastic loop.

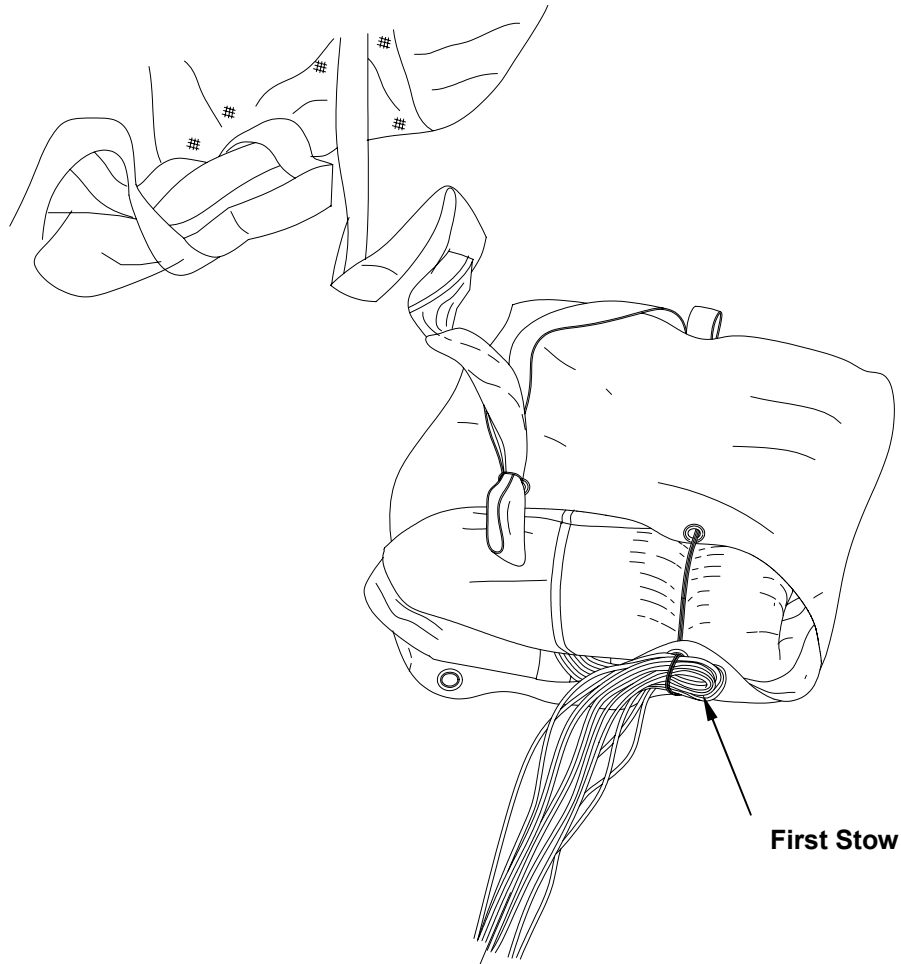
**NOTE**

The sewn portion of the elastic stow loop will not be exposed.

2. Make second locking stow on the left and remove bridle. Stow will not protrude more than 1 3/4-inch through elastic loop.

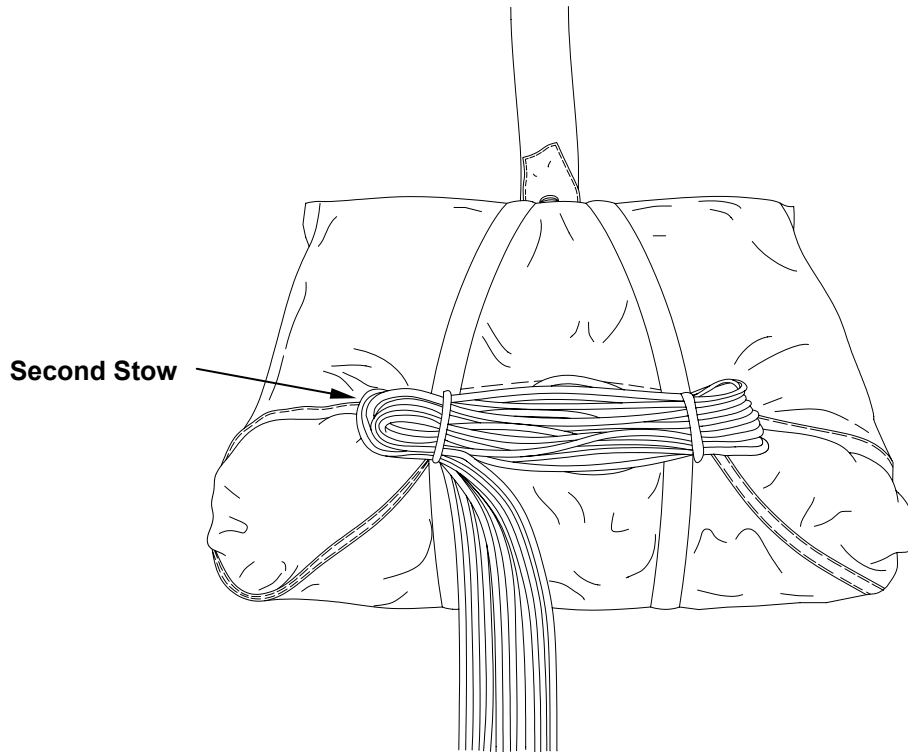

3. Rotate deployment bag up and open suspension line retaining pocket.

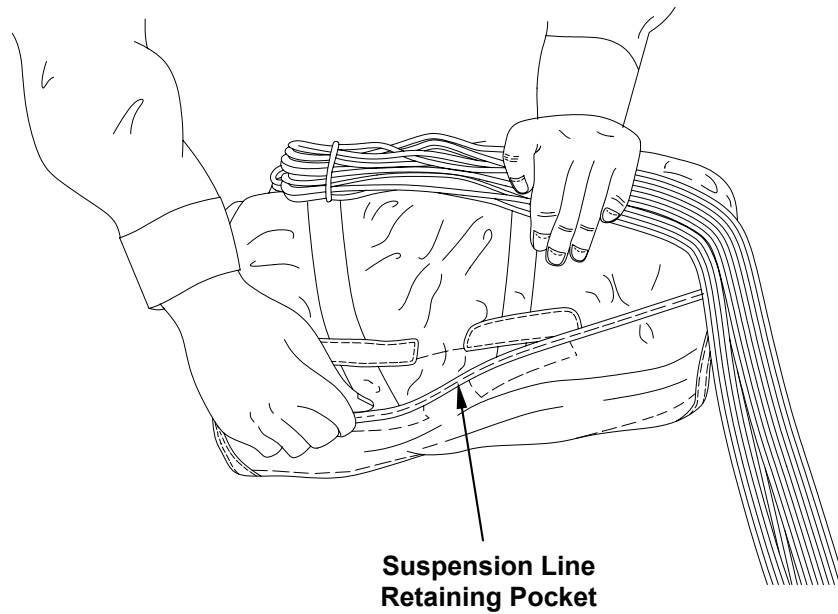

4. S-fold suspension lines into pocket from bottom to top, taking care not to put twists into the lines.

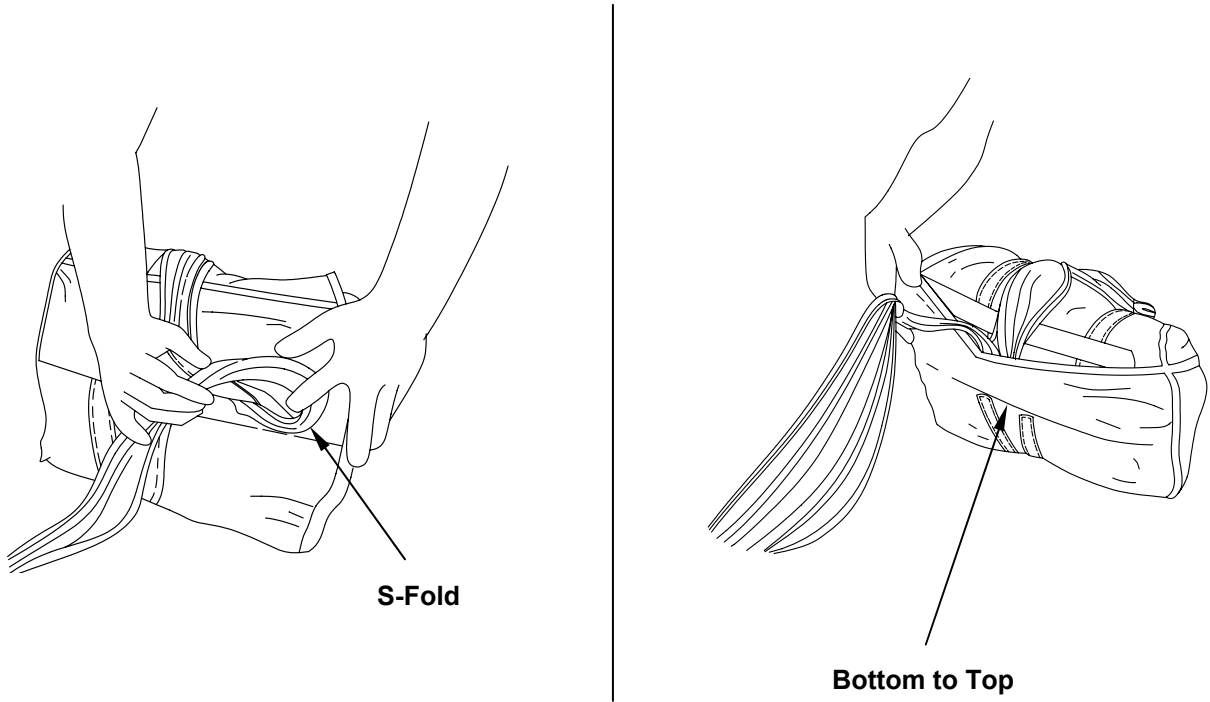

5. Mate hook and pile tape on bag pocket with lines exiting center. Leave approximately 8-inches between bag and risers.

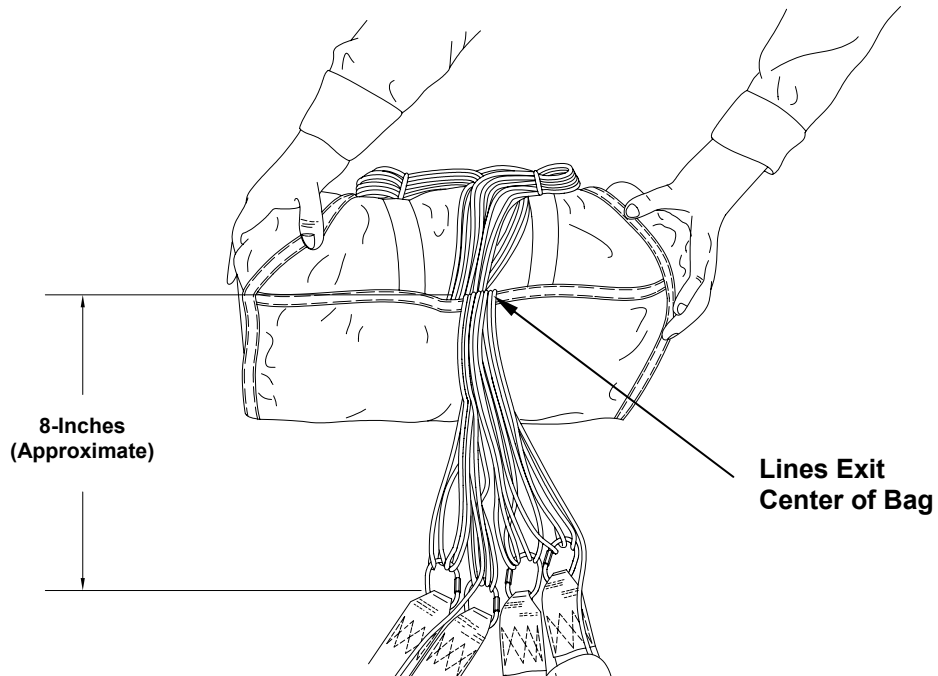

6. Rigger check number 4.

### CLOSING CONTAINER

Close Container as follows:

#### WARNING

The reserve parachute-closing loop will be replaced at each reserve parachute repack cycle (120-days). Failure to comply may result in a malfunction of the parachute and injury, or loss of life, to personnel.

1. Rotate deployment bag up and over main parachute compartment. Line stowage pocket will face up. Position risers in reserve container. Insert pull-up cords through ends of reserve closing loop and elastic locking loop. Measure length of elastic locking loop from washer to end of loop. Measurement must be no longer than 1-inch.

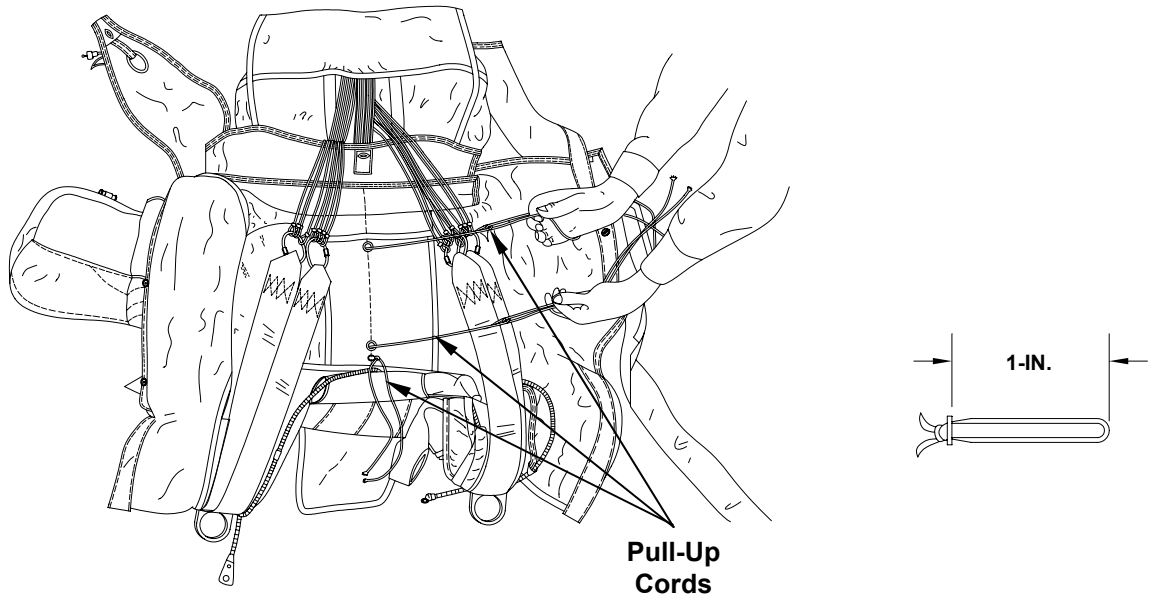

2. Rotate deployment bag into reserve compartment. Line stowage pocket will face down and bridle line will exit top of container. Suspension line locking stow faces toward main parachute compartment.

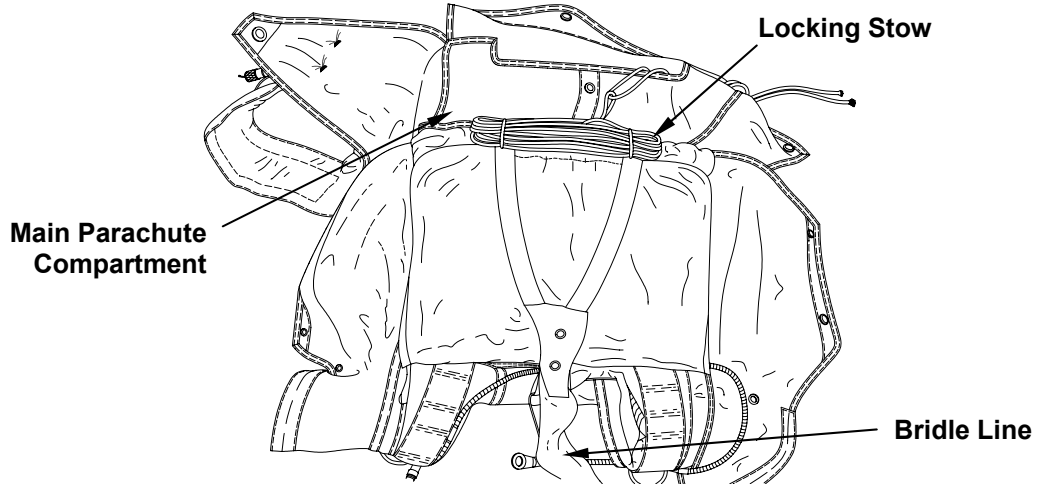

3. Route pull-up cord with closing loop through inside grommet on bridle line. Route pull-up cord with elastic loop through outside grommet on bridle line.

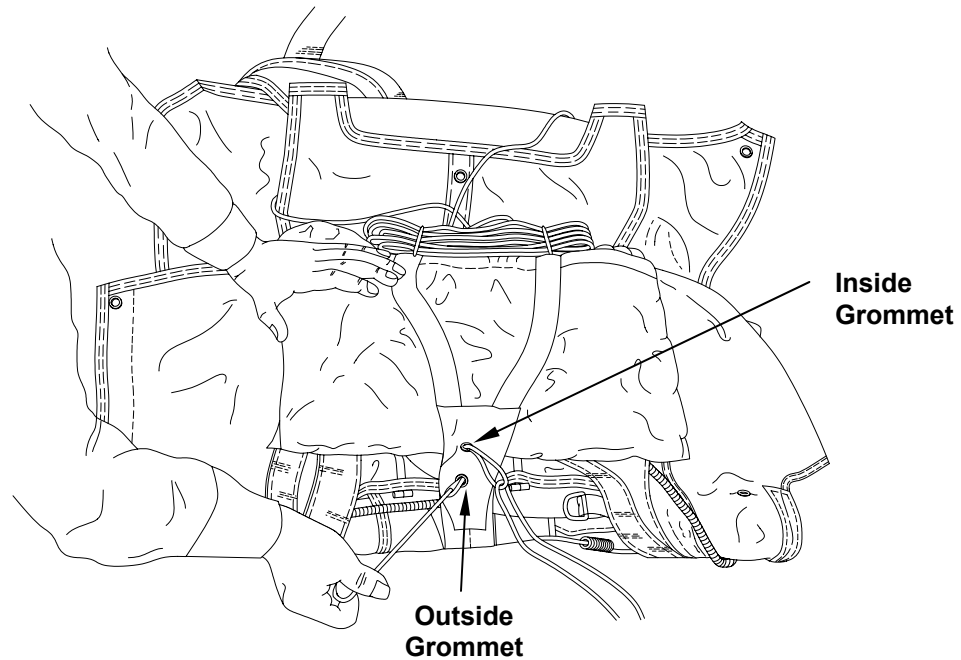

4. Prepare to form a needle fold in bridle line by first folding bridle back over itself approximately 4-inches above bag.

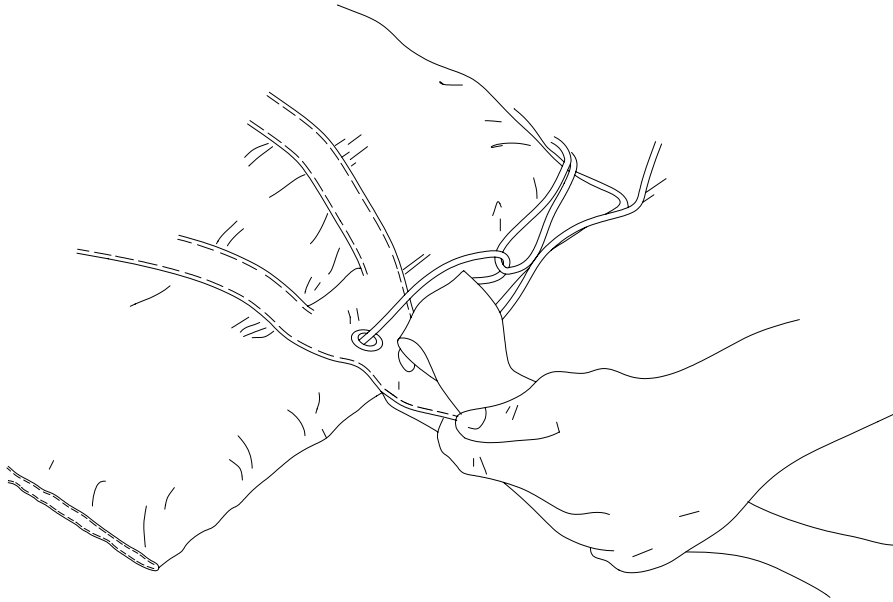

5. Continue to make needle fold by folding first 4-inch fold at a 45-degree angle.

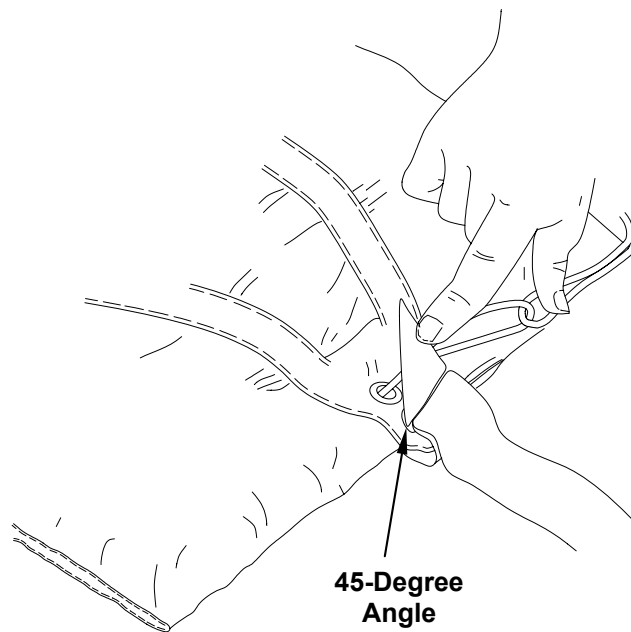

- Fold previous 45-degree angle fold in half.

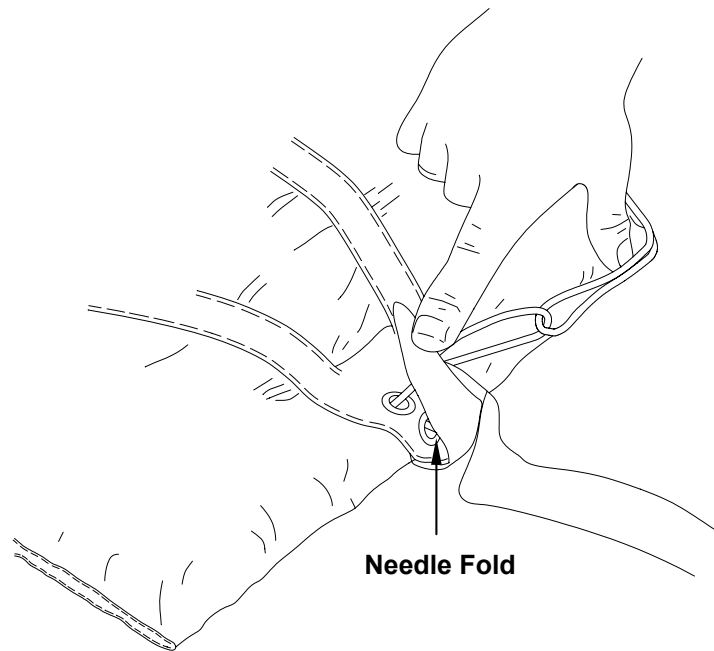

- Insert needle fold through elastic locking loop with aid of pull-up cord. Fold will not extend no more than 1-inch through loop. Remove pull-up cord.

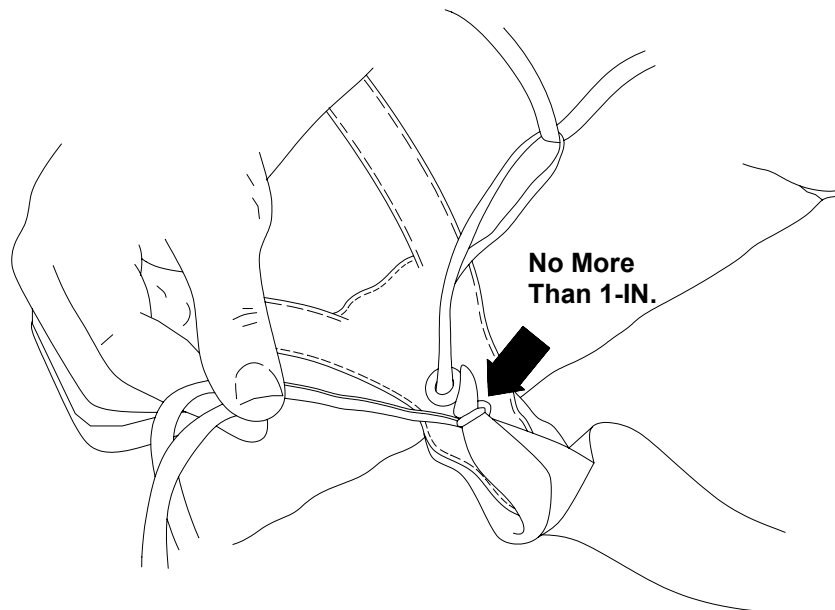

8. Rigger check number 5.
9. S-fold bridle line on top of deployment bag.

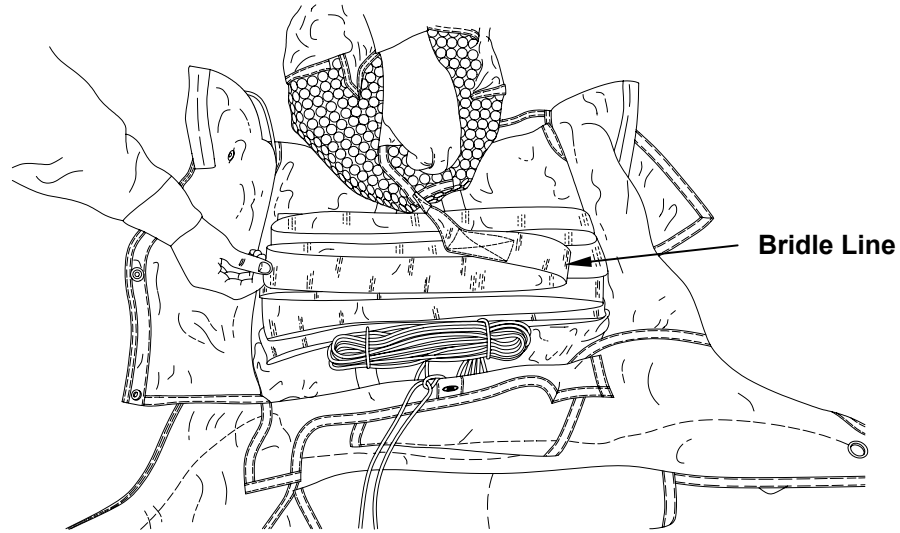

10. Center pilot chute on S-folds and then route pull-up cords through lower pilot chute grommet tabs. Insert properly flagged temporary locking pins.

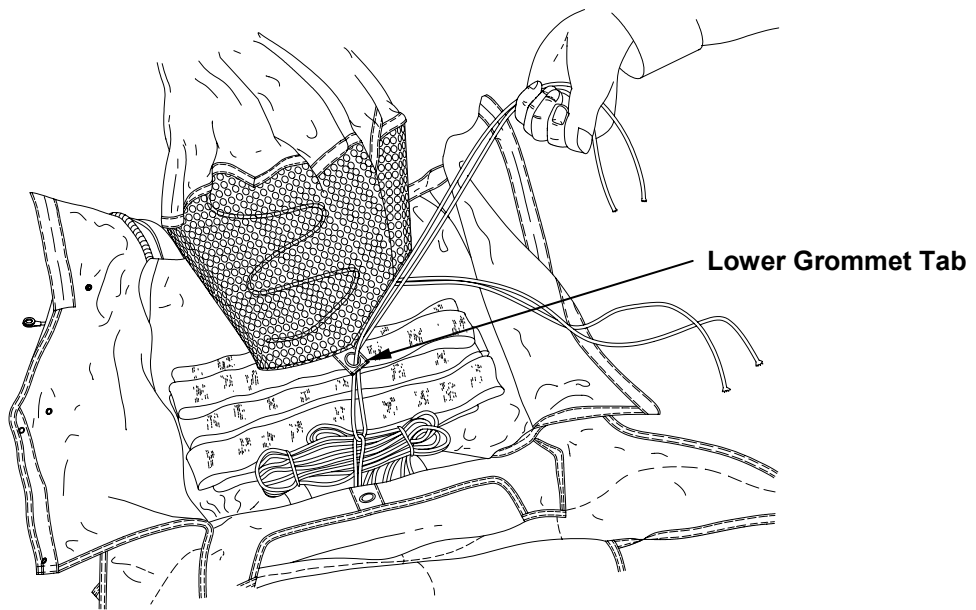



11. Route pull-up cords through upper pilot chute grommet tabs. Compress pilot chute, ensuring that canopy fabric is clear of spring, grommets and closing loops. Canopy fabric will be distributed to left and right sides of pilot chute. Pull closing loops up through tabs and insert temporary locking pins.



12. Route pull-up cord through grommet in bottom flap. Pull up closing loop and reinsert temporary locking pin.

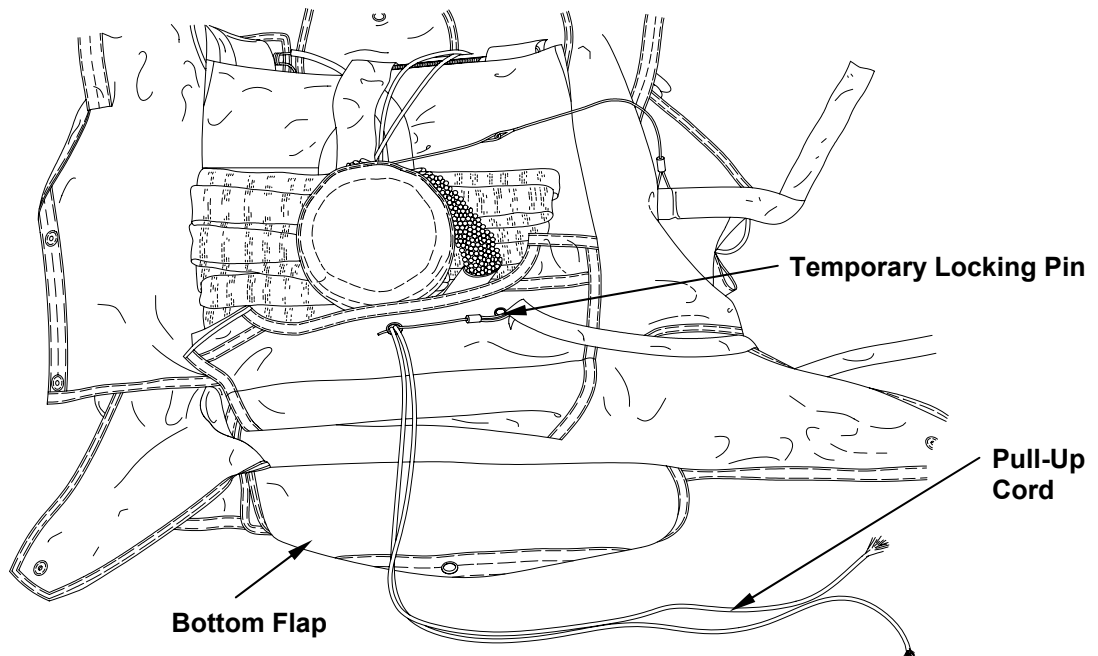

13. Route pull-up cords through grommets in right side flap. Pull closing loops and reinsert temporary locking pins.

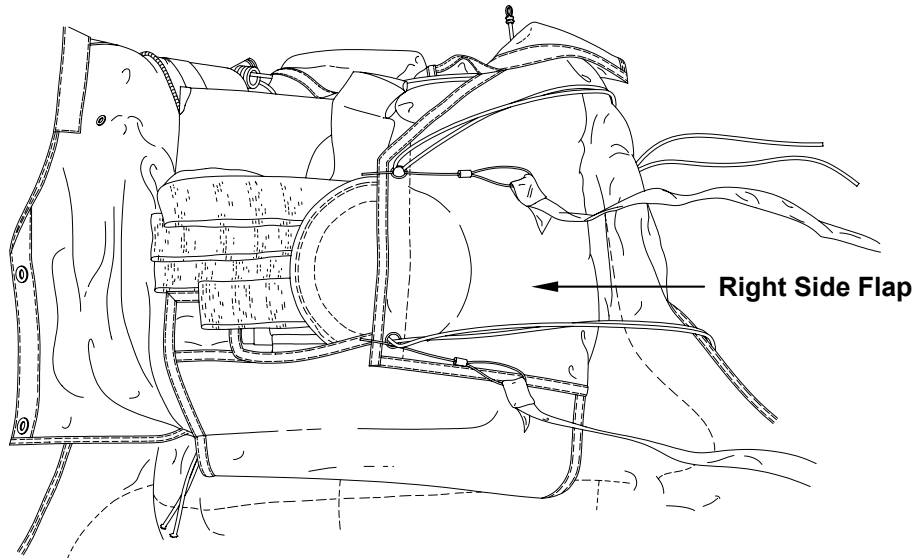

14. Route pull-up cords through grommets in left side flap. Pull up closing loops and reinsert temporary locking pins.

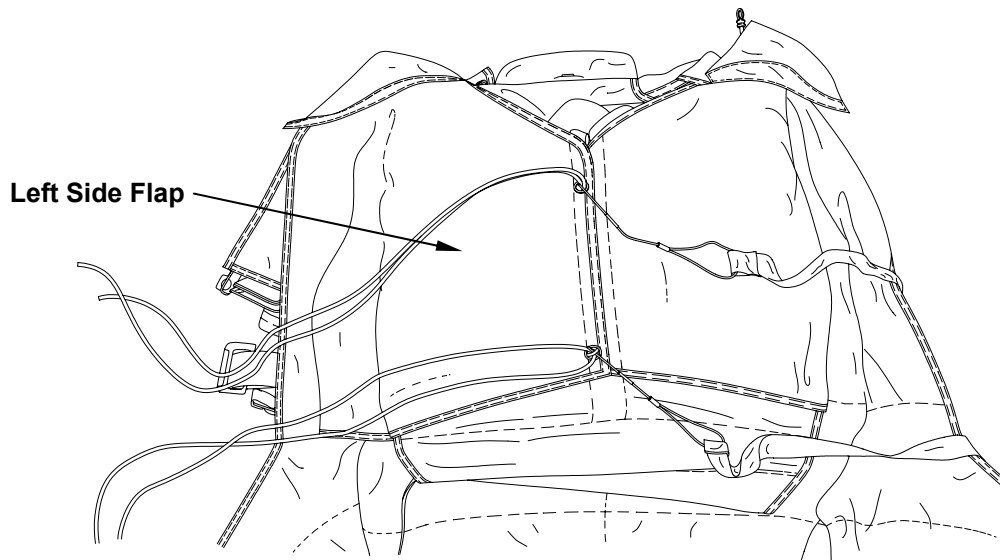

15. Rigger check number 6.

16. Ensure reserve ripcord is through ripcord housing and insert ripcord grip in ripcord pocket. Insert reserve ripcord cable through reserve static line pull ring, then through reserve static line guide ring. Mate static line and container hook and pile tapes.

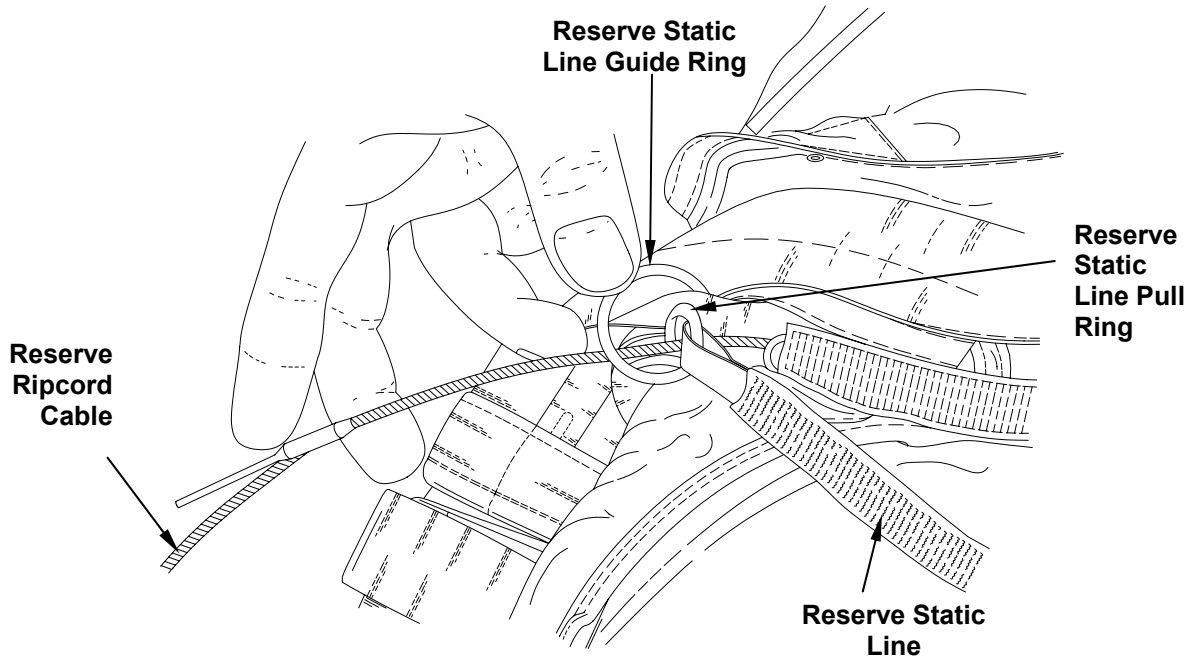

17. Route pull-up cords through grommets in top flap, pull up closing loops, and reinsert temporary locking pins.

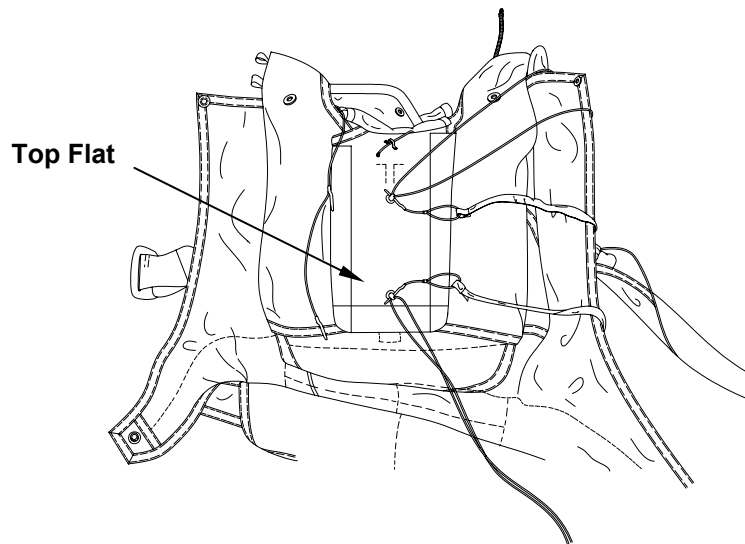

18. Pull up top pull-up cord, remove temporary locking pin, and inset top ripcord pin into closing loop.

19. Pull up bottom pull up cord, remove temporary locking pin, and insert bottom ripcord pin into closing loop.
20. For reserve mounted AR2s, pull up top pull up cord and remove locking pin. Thread eye of power cable over top pin of ripcord. Insert top ripcord pin into closing loop (detail A). Axis of ripcord pin will follow the angled hole in the eye of the power cable (detail B). Center straight portion of ripcord pins in closing loops and ensure that shoulders of pins remain outside of grommets.

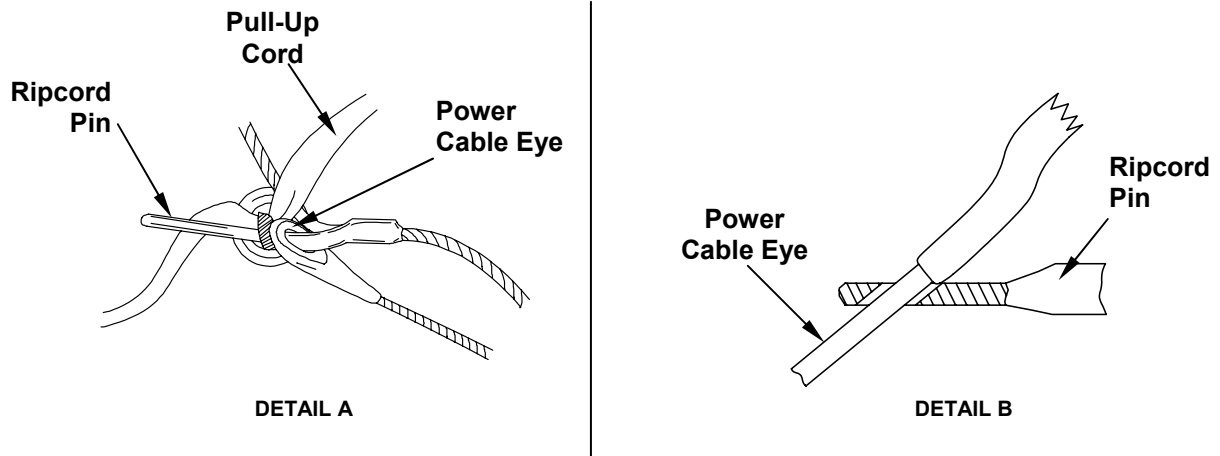

21. Conduct a Slack Checker Inspection Test as indicated in WP 0011 00.

**NOTE**

The following ripcord pull tests are performed on all MC-4 systems on a one-time only basis.

22. Place parachute in test fixture or anthropometrical device (torso) simulating the 5-to-95 percentile person or live subject. The device shall hold parachute securely in a position with the mouth of the ripcord pocket facing down (along the vertical axis).

23. Rotate harness/container so that open end of ripcord housing faces down with ripcord cable in a vertical position.

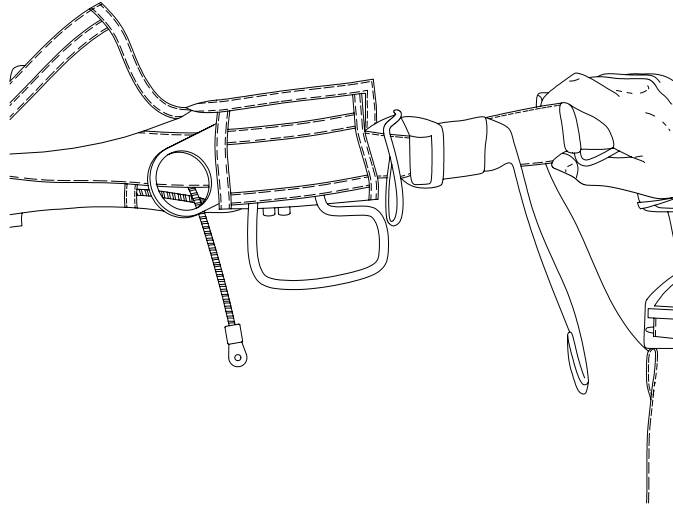

24. Secure ripcord handle by hand to prevent ripcord pin withdrawal when weight is applied.
25. A 20-pound weight attached to the center of the ripcord grip (care shall be exercised not to impose an impact load) shall readily withdraw ripcord grip from pocket.

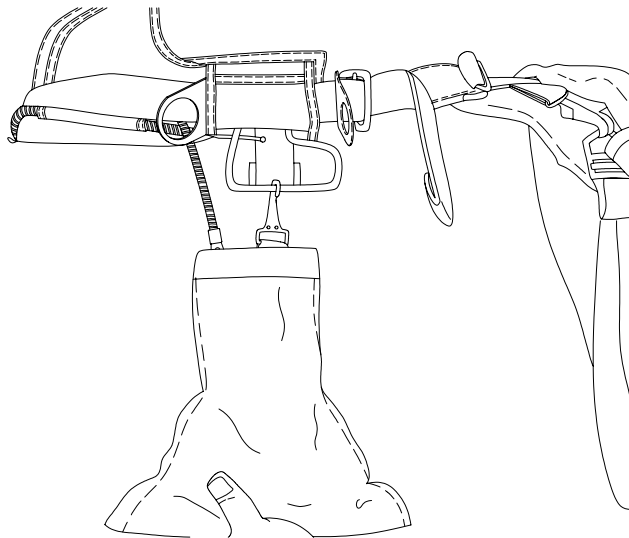

26. When ripcord grip has been removed from pocket, carefully remove the 20-pound weight.

---

**NOTE**

---

The following ripcord pull test and stroke simulator test are performed on all MC-4 systems each time the reserve parachute is packed.

27. Remove the ripcord from the ripcord grip pocket.
28. Attach a 27-pound weight to ripcord grip. Slowly remove your hand. The weight shall readily activate the parachute by withdrawing the ripcord pins from locking loops.

---

**NOTE**

---

It is not necessary to start the pack process over again if the same initial packer is conducting the Ripcord Pull Tests. If a different Parachute Rigger has taken over any of the tasks associated with the Ripcord Pull Tests, then a complete re-pack of the reserve parachute is required.

---

**NOTE**

---

Re-closing the container after the ripcord pull test does not constitute a repack toward the normal repack cycle (120-days). Repack and replace the reserve closing loop at the specified repack interval.

29. Close the container IAW the procedures detailed above. Reinsert the ripcord pin(s) threading top pin through eye of power cable (detail A above).

**STROKE SIMULATOR TEST (Reserve Mounted AR2)**

Conduct a Stroke Simulator Test as follows:

---

**NOTE**

---

The Stroke Simulator Test (power cable length of travel) will be performed each time a power cable is installed on the harness/container, each time the reserve parachute is packed, and when the AR2 has actuated during a jump.

---

**WARNING**

---

The Stroke Simulator must be able to pull both reserve ripcord pins positively and completely to ensure adequate travel of the AR2 power cable. Inadequate travel of the AR2 power cable may cause the parachute to not deploy, resulting in serious injury or death of the parachutist.

---

**NOTE**

---

If ripcord pins fail to pull completely, check the length of the reserve closing loop, the condition of the backing plate, power cable housing and routing of power cable assembly.

1. Test routing and installation of the power cable assembly in the parachute harness/container while the harness/container is being worn in the normal fashion.
2. Connect stroke simulator to power cable assembly in place of the AR2.
3. Firmly hold stroke simulator adjacent to the AR2 pocket in a vertical orientation (i.e. stroke simulator plunger pointing down).
4. With assistance from another individual, carefully attach a 33-pound weight to the stroke simulator plunger and very slowly remove your hand from under the weight to allow the weight to be slowly transferred to the stroke simulator.
5. The weight must completely withdraw the ripcord pins within the available stroke.
6. Maintain control of the reserve pilot chute in an effort to prevent the entire contents of the reserve parachute from falling to the floor.
7. If the 33-pound weight hesitates or fails to pull the ripcord pins, remove and inspect the entire power cable assembly IAW this technical manual, WP 0047 00 and TM 10-1670-305-23&P, WP 0019 00. If unserviceable, replace with a new item from stock, then repeat Slack Checker Test and Stroke Simulator Test above. If the system fails a second time, it must be tagged and removed from service IAW WP 0011 00.
8. Detach stroke simulator from power cable.

---

**NOTE**

---

It is not necessary to start the pack process over again if the same initial packer is conducting the Stroke Simulator Test. If a different Parachute Rigger has taken over any of the tasks associated with the Stroke Simulator Test, then a complete re-pack of the reserve parachute is required.

---

**NOTE**

---

Re-closing the container after the stroke simulator test does not constitute a repack toward the normal repack cycle (120-days).

Repack and replace the reserve closing loop at the specified repack interval.

**NOTE**

Parachute systems that do not pass the inspection will be removed from service.

9. Close the container IAW the CLOSING CONTAINER procedure above. Reinsert the ripcord pin(s) threading top pin through eye of power cable (detail A above).
10. At the completion of stroke simulator test, remove pull-up cords by routing underneath ripcord pins.

**NOTE**

Due to the continuous entries into the Parachute Log Record Book, authorization is granted to locally produce an internal tracking document that captures these required entries. If no such document exists, entries must be made into the Parachute Log Record Book.

11. After testing has been completed and the specified requirements are met, remove Parachute Log Record from log record pocket on underside of ripcord pin protector flap and make required entries. Reinsert log record into log record pocket. Close ripcord pin protector flap. Dress the container.



12. Rigger check number 7.



**ATTACHMENT OF THE AR2 (Reserve Mounted AR2)**

Attach the AR2 as follows:

**WARNING**

When attaching the power cable assembly to the AR2, always verify proper engagement of ball end of power cable with piston rod of AR2 by looking through transparent plastic cable seal retainer. Cable seal retainer and power cable seal must be present to ensure correct seating of power cable ball. If ball is not engaged with piston rod or if cable seal retainer is missing, actuation of AR2 will fail to pull ripcord pins, which may result in death of parachutist.

**CAUTION**

Finger tighten the power-housing retainer. Do not use pliers or other tools that will over tighten power-housing retainer.

**CAUTION**

Ensure container is handled with care when transporting container with the AR2 installed. Failure to do so may result in damage to equipment.

**NOTE**

Make sure the AR2 is cocked, and the JUMP/OFF switch is set to OFF.

**NOTE**

Prior to installing the AR2 in the ripcord release pocket, remove the storage cable and piston rod cap, if present. Save these components for future use.

1. Ensure that the AR2 JUMP/OFF switch is OFF.

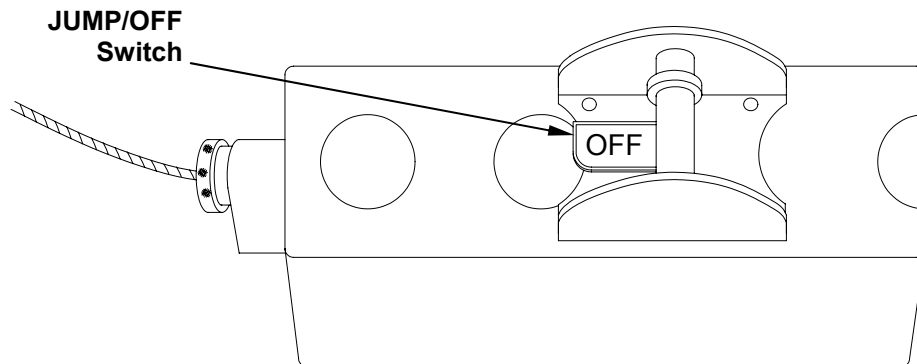

2. Verify that the ball of the power cable is correctly engaged with the piston rod.

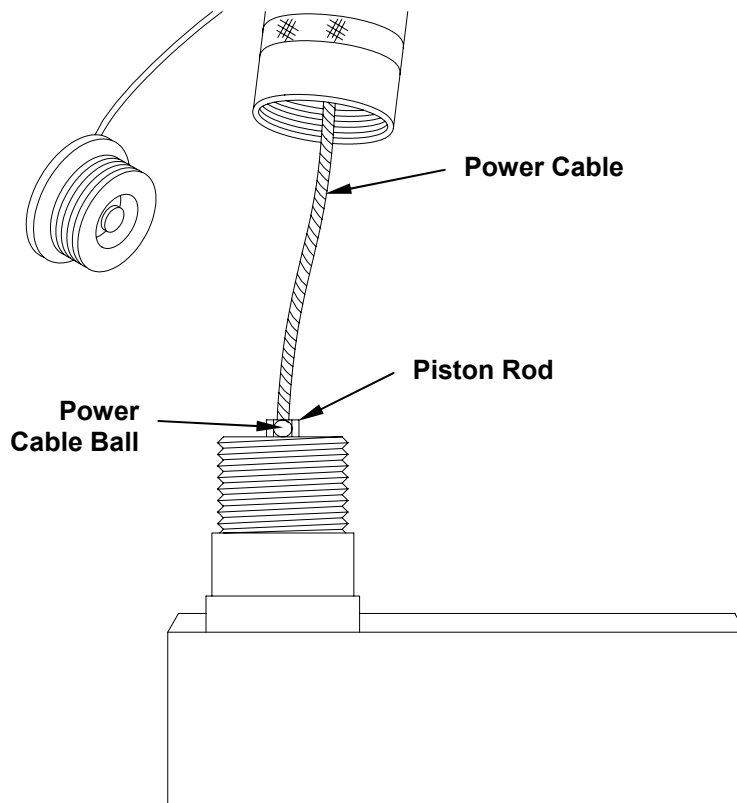

3. Attach power housing retainer to the AR2 finger tight. Verify that the ball of the power cable is correctly engaged with the piston rod by looking through transparent cable seal retainer.
4. Ensure that the cable seal retainer is present.
5. Install the AR2 in the ripcord release pocket and close flap.
6. Rigger check number 8.

**END OF WORK PACKAGE**



---

**MC-4 RAM AIR FREE-FALL PERSONNEL PARACHUTE SYSTEM  
PACKING PROCEDURES – MAIN PARACHUTE**

---

**THIS TASK COVERS**

- Pack-In-Process Inspection
  - Attaching Risers to Harness
  - Layout and Line Check
  - Flaking Canopy
  - Folding Canopy
  - Setting Deployment Brakes
  - Stowing Canopy in Deployment Bag
  - Stowing Suspension Lines
  - Closing Container
  - Installing Automatic Opening Device
- 

**INITIAL SETUP:****Tools**

Pins, Temporary Locking (Item 31, WP 006300)  
Stroke Simulator (Item 41, WP 0063 00)

**Materials/Parts**

Band, Rubber Retainer (Item 4, WP 0076 00)  
Cord, Nylon, Type III (Item 13, WP 0076 00)  
Thread, Cotton, Size 24/4 (Item 40, WP 0076 00)

**Equipment Condition**

Lay canopy and suspension lines out to their full length in packing area. Position container at risers with main and reserve compartments up and reserve compartment facing toward canopy and risers.

**Personnel Required**

92R (10) Parachute Rigger  
92R (20) Parachute Rigger

---

**WARNING**

Failure to detect areas of damage during packing, or failure to comply with the following procedure, may result in a malfunction of the parachute and injury or loss of life to personnel.

**NOTE**

The parachute will be packed every 120-days.

**NOTE**

Inspect main parachute deployment bag, bridle and pilot parachute for damage.

**NOTE**

Remove main parachute ripcord handle and clean with a clean, dry, lint free cloth. In addition, clean the ripcord handle pocket by removing any debris. Re-install main parachute ripcord handle.

**PACK-IN PROCESS INSPECTION**

A rigger supervisor other than the packer during the applicable packing process shall conduct the pack-in-process inspection. This inspection is required to ensure that only authorized packing procedures are used. The prescribed intervals to conduct the pack-in-process inspection are as follows:

1. Proper Layout
  - a. Main canopy release ripcord installed
  - b. Risers attached to harness
  - c. Line check complete
  - d. Canopy flaking complete
2. Slider Up
  - a. Canopy folding complete
  - b. Deployment brakes set
  - c. Tail folding complete
  - d. Slider pulled up and positioned
3. Four Locking Stows
  - a. Canopy stowing complete
  - b. Deployment bag locking stows complete
4. Suspension Lines Stowed
5. Packing Complete
  - a. Container closed (bottom, left, right, top)
  - b. All packing aids removed
  - c. Log record book filled out
6. Automatic Opening Device Installed

**ATTACHING RISERS TO HARNESS**

Attach risers to harness as follows:

1. Insert main ripcord cable through main ripcord housing. Insert main ripcord grip into ripcord grip pocket. If removed, clean and lubricate single point release IAW WP 0011 00. Insert single point release cable through cable housings. Mate hook tape on grip with pile tape on harness. Attach reserve static line to container with reserve static line pull ring facing top of container. Pass reserve ripcord cable through reserve static line pull ring and then through reserve static line guide ring.

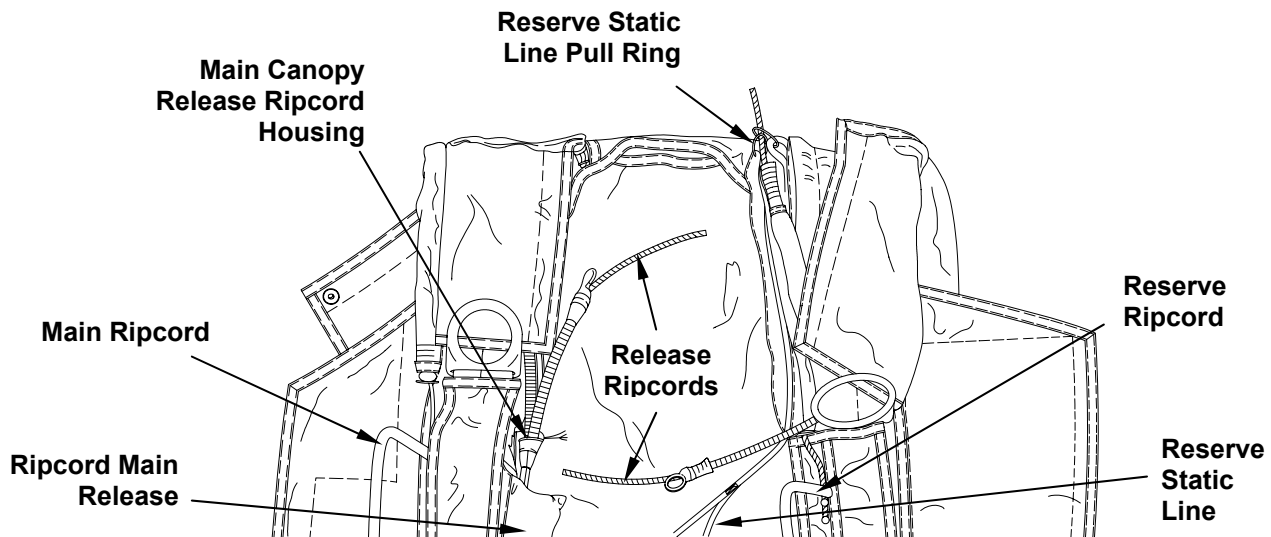

2. Position right riser on harness above main ripcord and pass large ring on riser through base ring on harness.

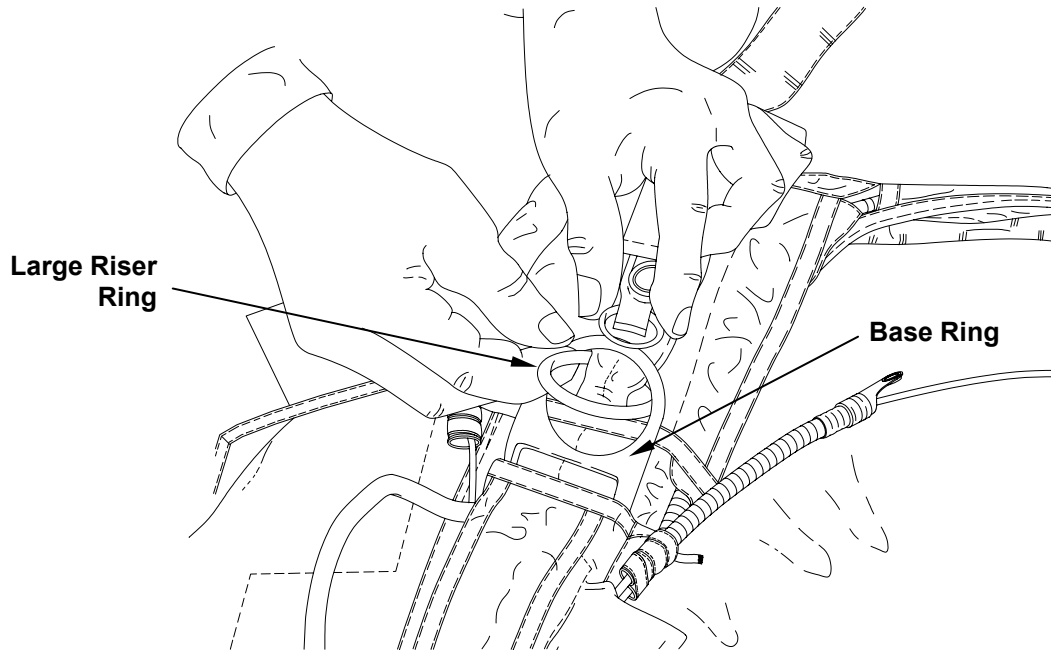

3. Pass small riser ring through large riser ring. Position small riser ring over riser grommet.

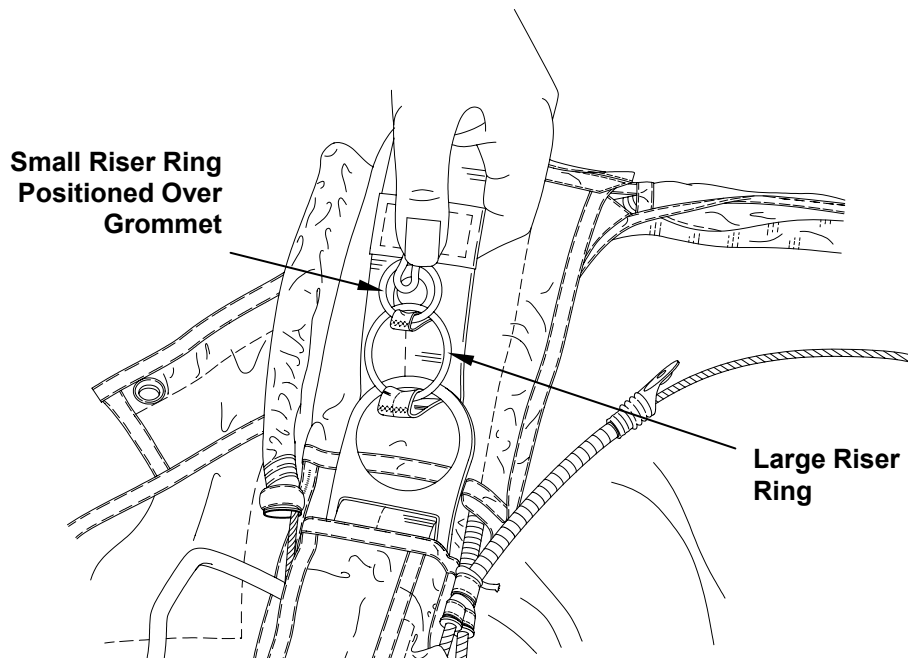

4. Pass locking loop over small riser ring and down through riser grommet. Ensure riser-locking loop is not twisted. Insert locking loop through eye on end of cable housing.

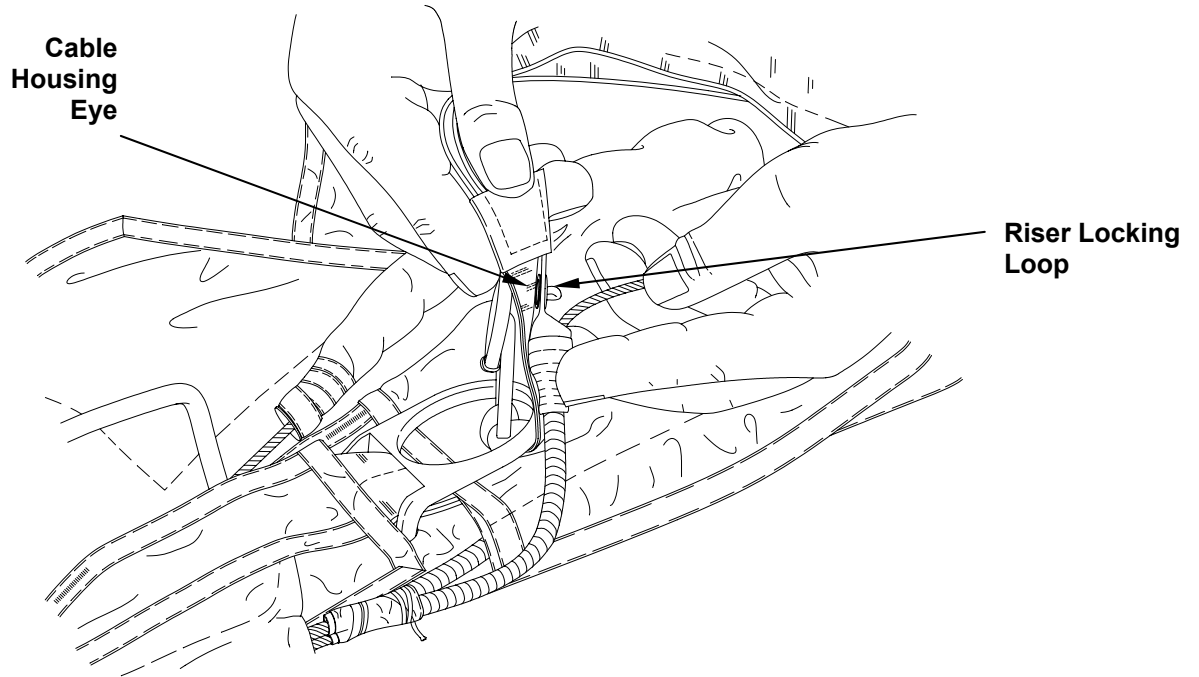

**NOTE**

Ensure riser locking loop is not twisted.

5. Pass main canopy release cable through locking loop and insert main canopy release cable in riser stowage flute.

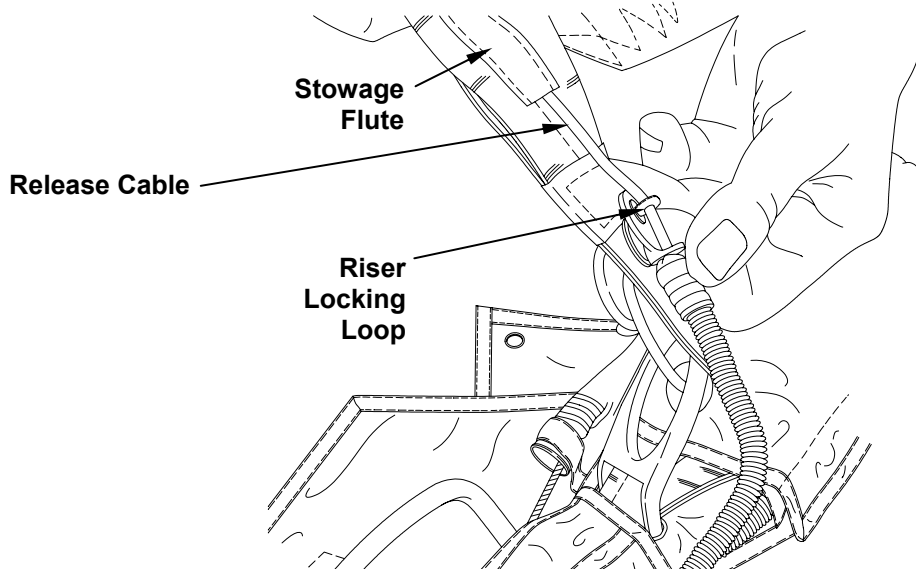



6. Attach left riser to harness in same manner as in step 2. through 5.
7. Connect reserve static line ring to reserve static line release shackle.

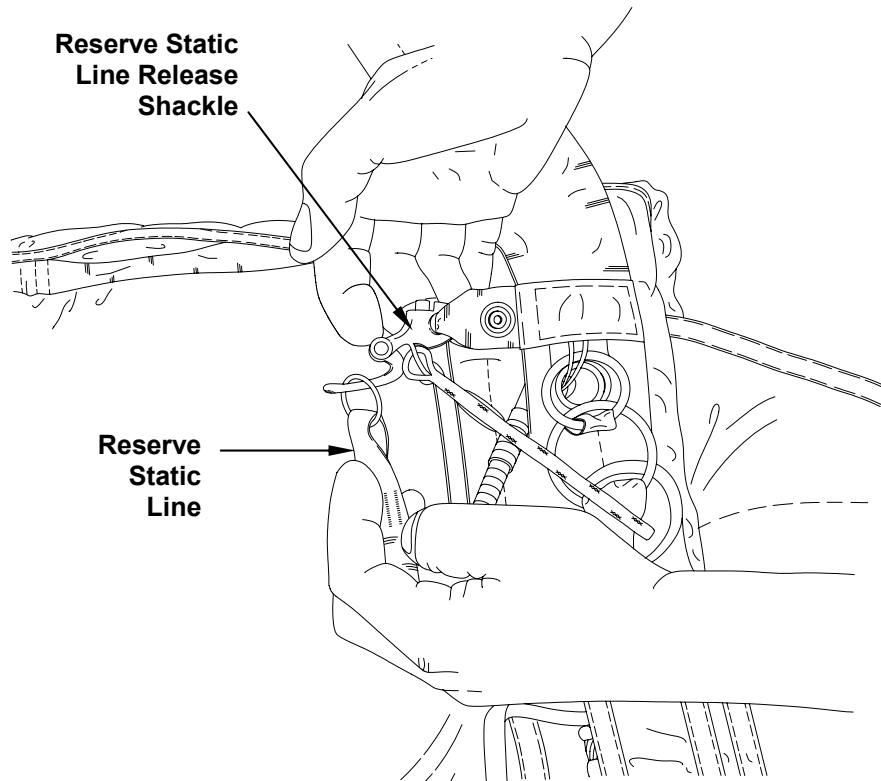

8. Mate snap on reserve static line release lanyard to riser snap.

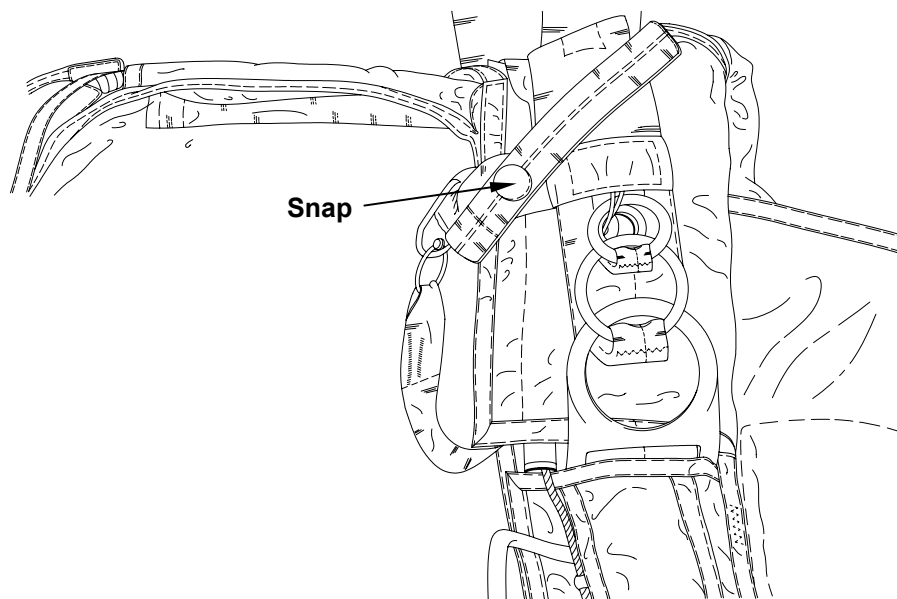

**LAYOUT AND LINE CHECK**

Perform layout and line check as follows:

1. Lay out parachute on a clean dry surface with canopy on its left side. Leading edge (nose) will be to the right when viewed from riser end. Stretch lines full length with a helper at riser end to check continuity and hold lines taut.
2. Grasp high points of each cell and, with high points in the left hand, flip canopy toward trailing edge. Canopy shall lie flat with trailing edge lines on left side when viewed from riser end.



3. Remove any twists, turns, and tangles between suspension line groups.
4. Raise lines 8A and 8B and walk them down (ensuring there are no twists) to see if line 8A runs free from canopy to outside of right front riser connector link. Line 1A should run free to outside of left front riser connector link.

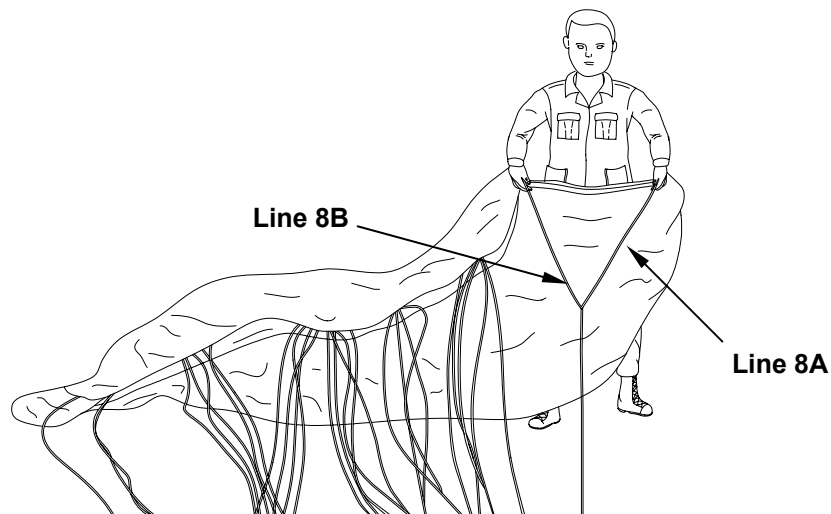

5. Raise lines 8C and 8D and walk them down (ensuring there are no twists) to see if line 8C runs free from canopy to outside of right rear connector link. Line 1C should run free to outside of left rear connector link.

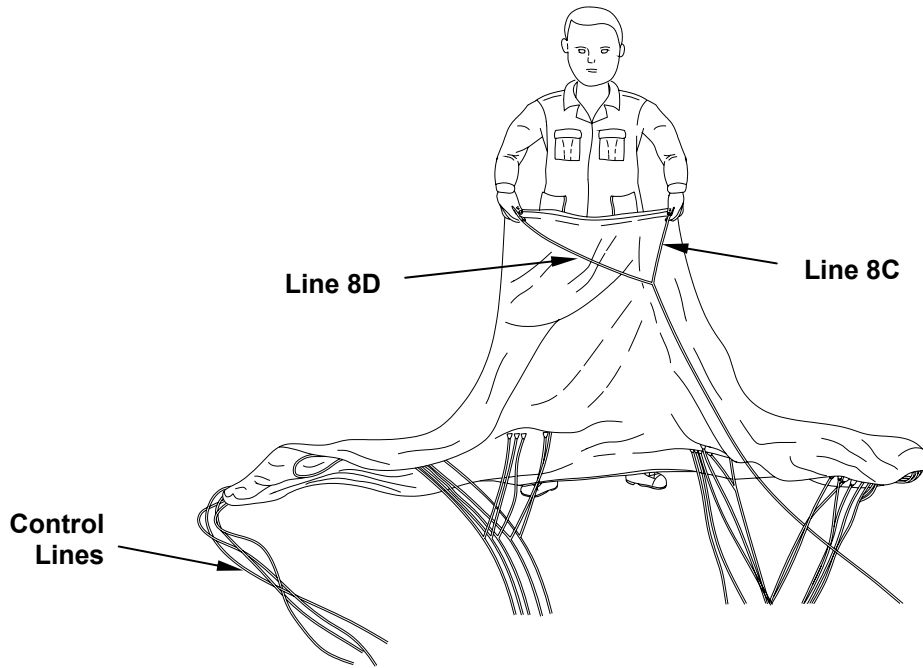

6. Raise control lines and walk them down (ensuring there are no twists) to ensure they run free from the A, B, C, and D lines.

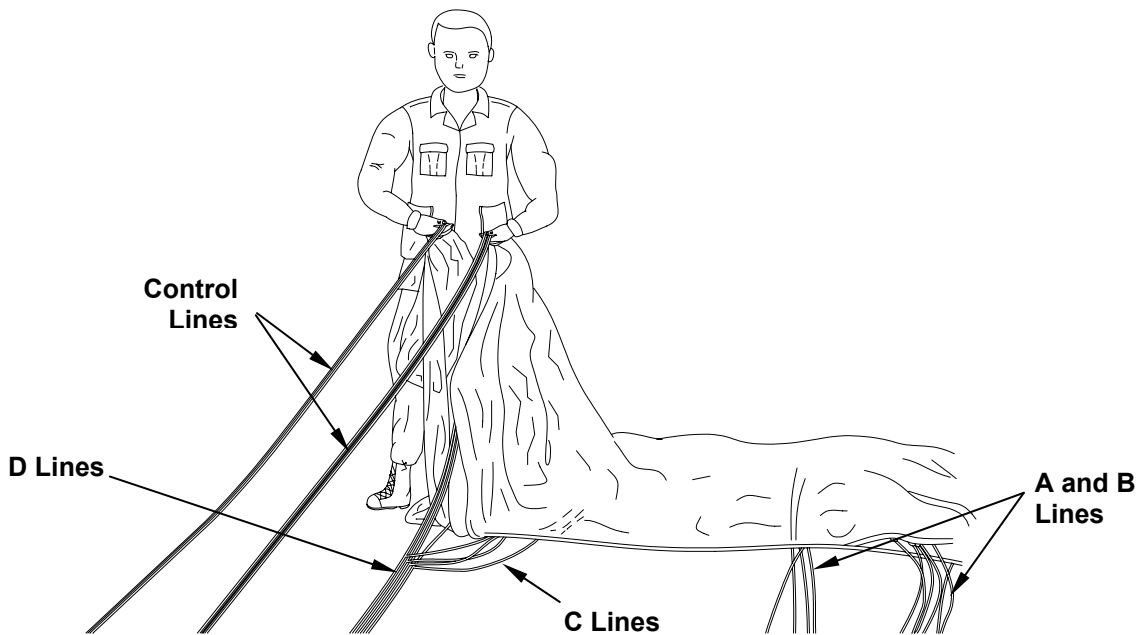

7. Ensure control lines pass through correct slider grommets, and then through correct control line guide rings.

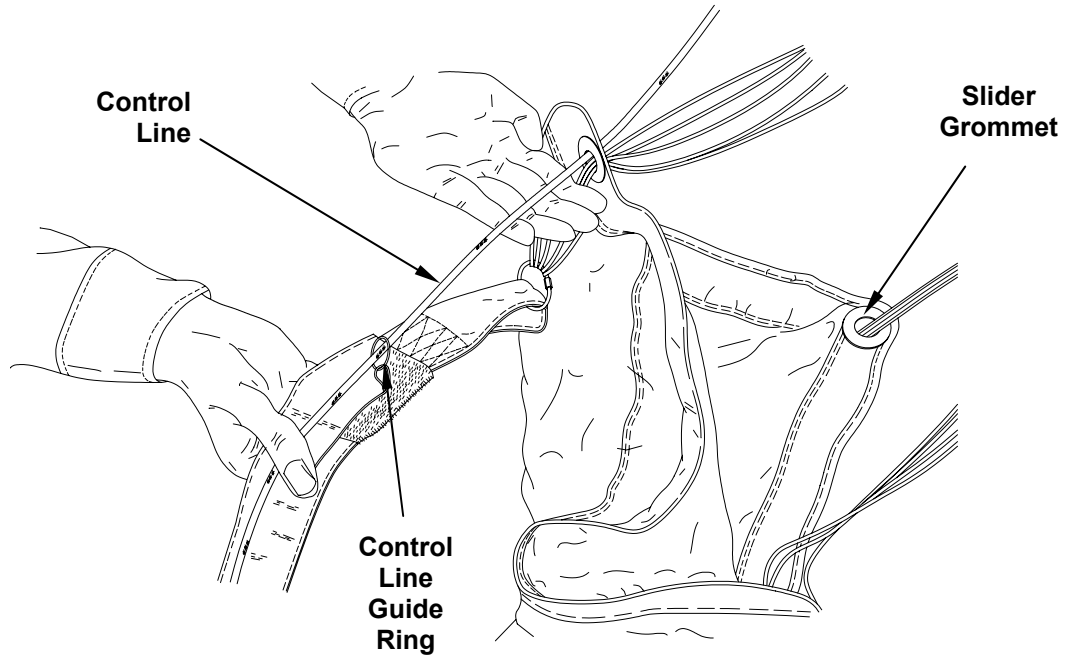

### FLAKING CANOPY

Flake canopy as follows:

1. Grasp tops of cells at high points. Throw canopy toward risers.



2. Starting with high points on cell 1, pull out seam and smooth cell from leading edge to trailing edge.

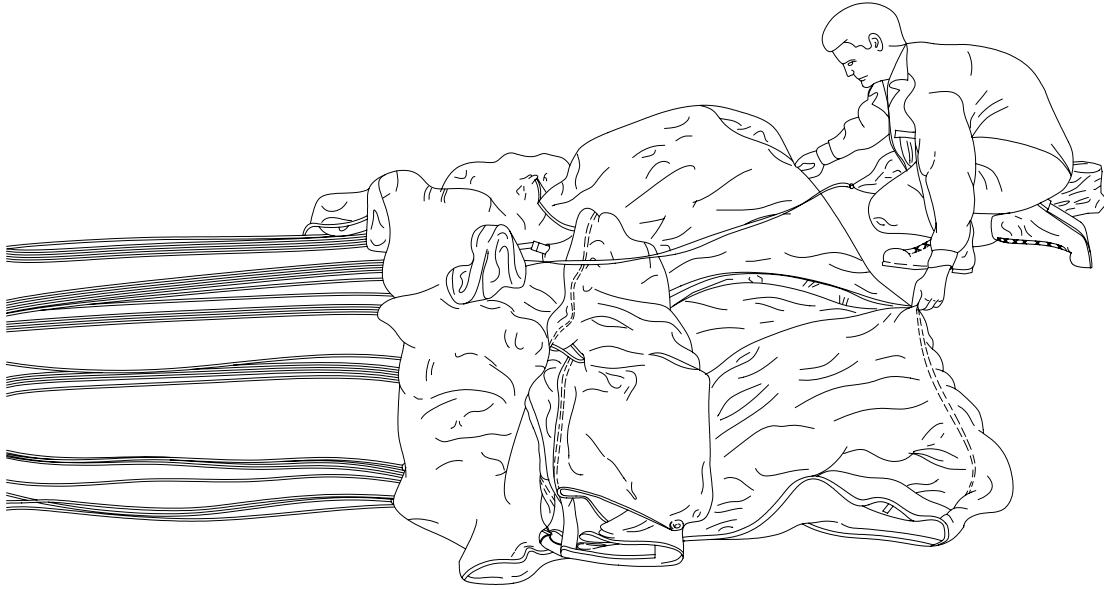

3. Continue to flake canopy by pulling out seams, one by one, on each remaining cell. Smooth each cell until all cells are flaked and all line groups are clearly separated and tight.

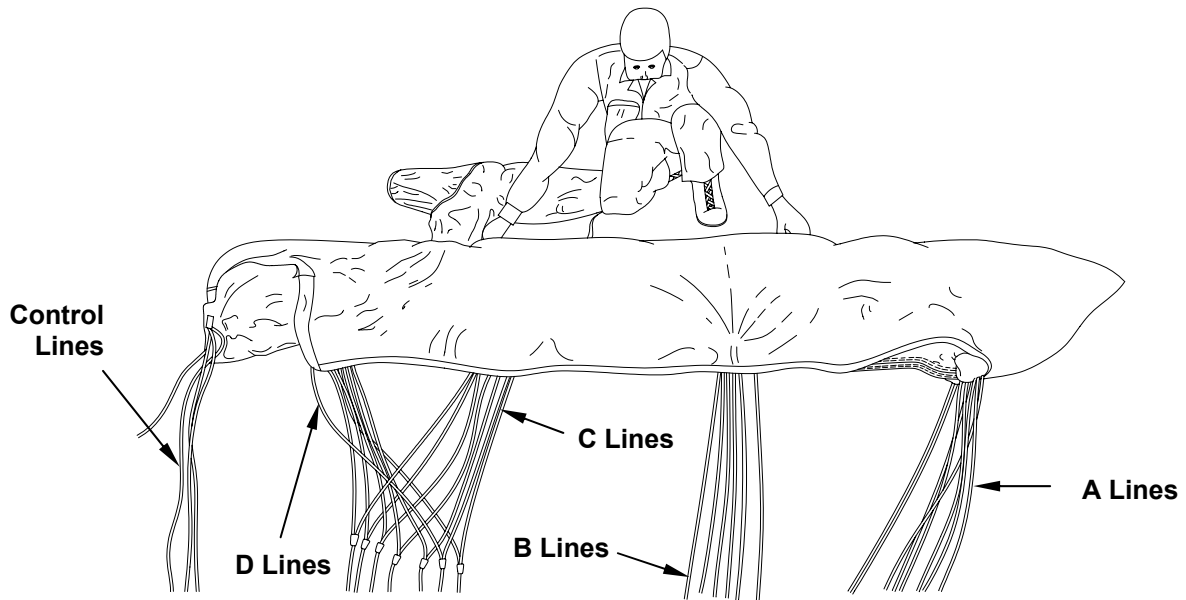

**FOLDING CANOPY**

Fold canopy as follows:

1. Fold leading edge over canopy so cell openings are even with A lines. Keep lines taut.

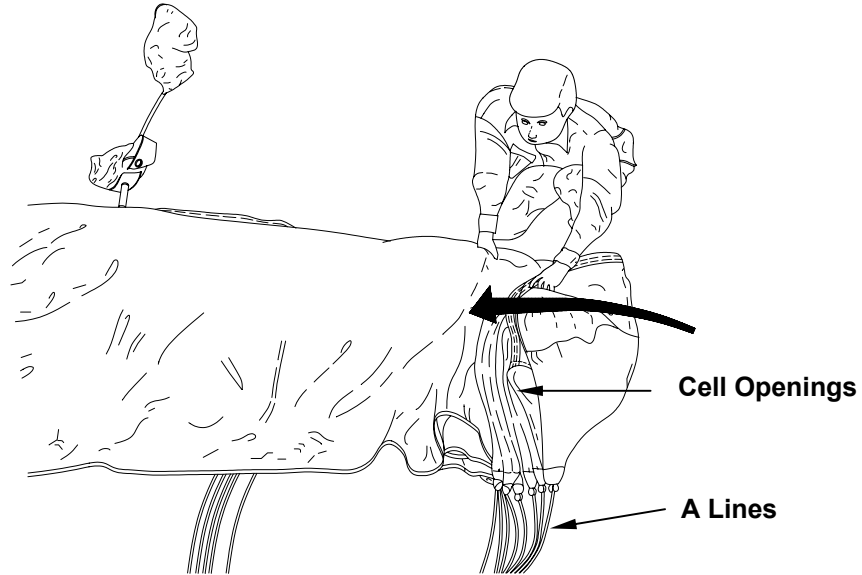

2. Grasp the high point of cell 1 and extend outward, smoothing out cell.

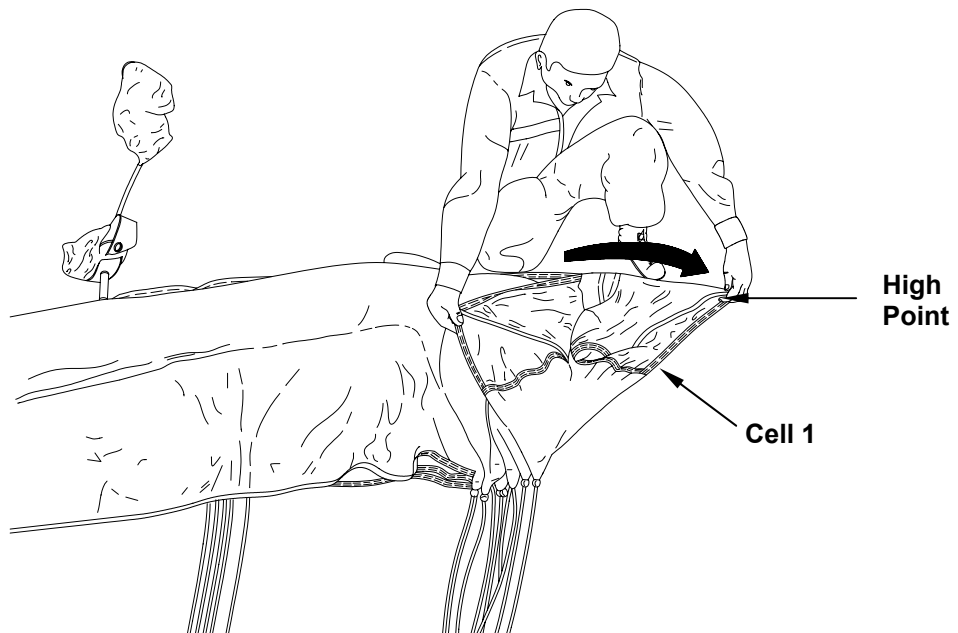

- Continue to grasp high point of each cell and extend outward, smoothing out each cell and aligning all cell openings.

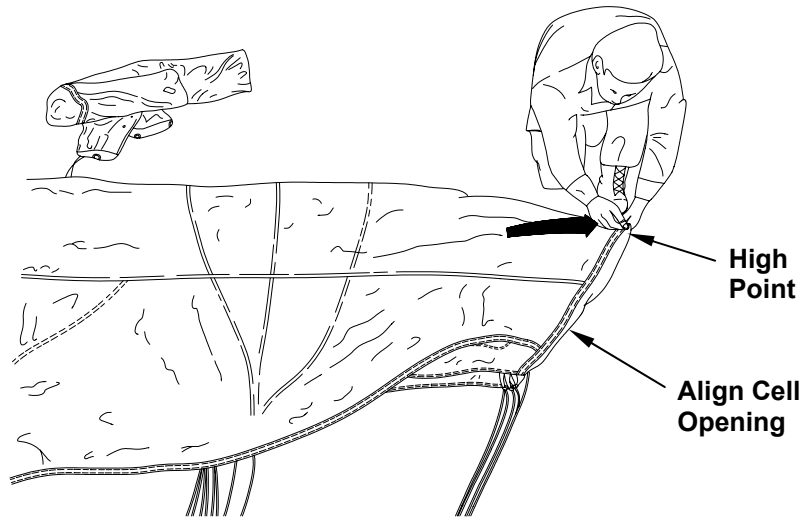

- Rigger check number 1.
- Grasp all cells at nose of canopy and form a fold line two-thirds of the way back between A and B lines. Keep lines taut.

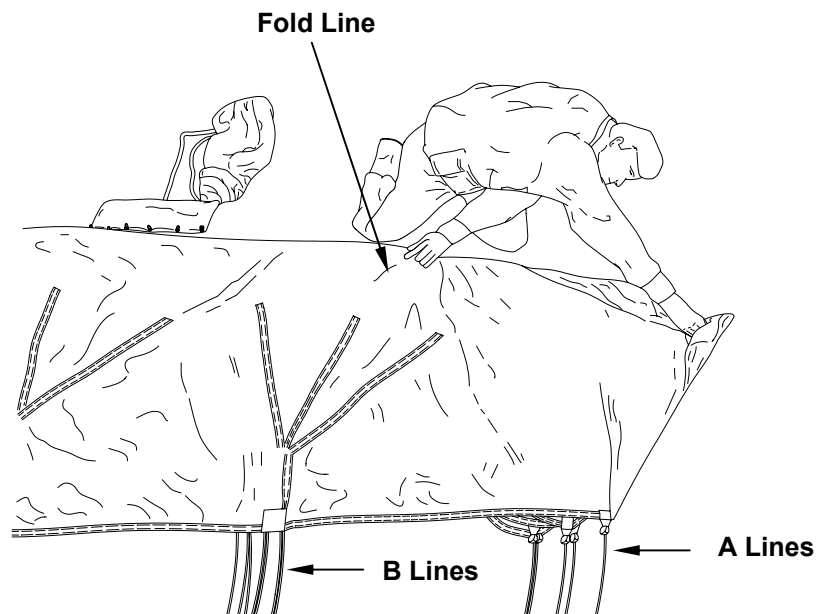

6. Rotate nose of canopy over on top of remainder of canopy placing the A lines just past the B lines. Keep lines taut.

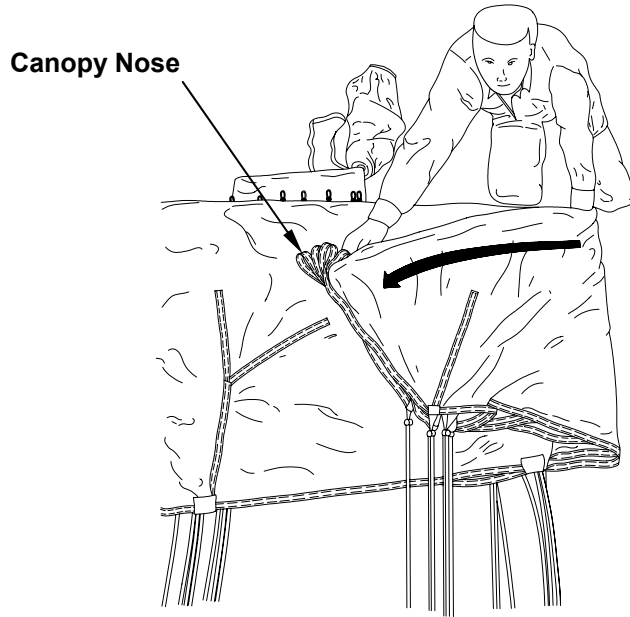

7. Make another fold towards front of canopy so that A lines are directly in line with B lines. Keep lines taut.

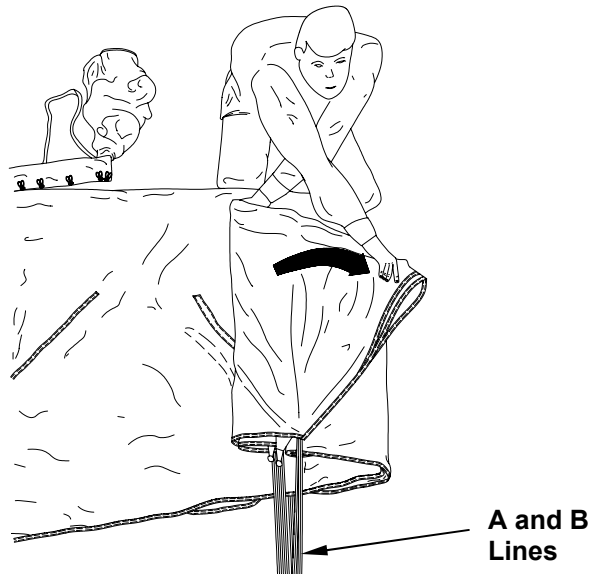



8. Fold nose of canopy back to edge of previous fold. Ensure A lines remain in line with B lines, and that lines are kept taut.

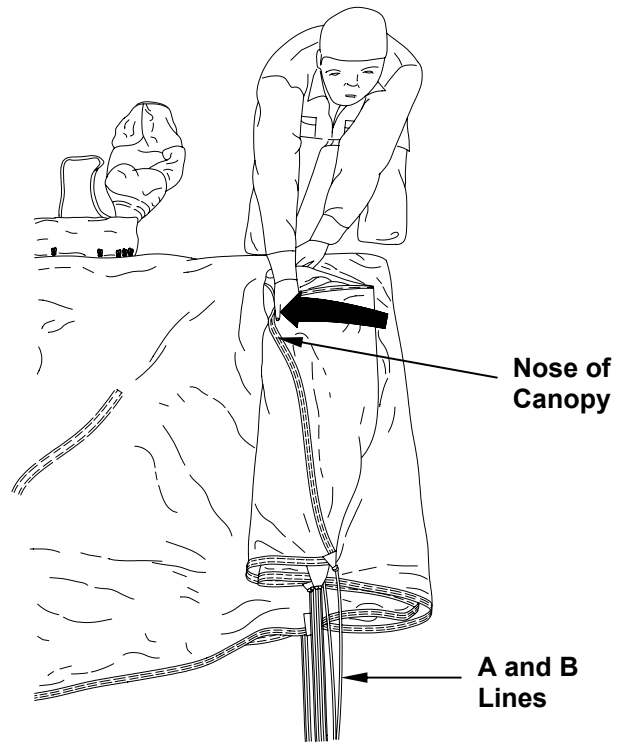

9. Holding all high points together in line with C line group, make an S-fold placing C line group on top of A and B line groups. Ensure high points are kept taut.

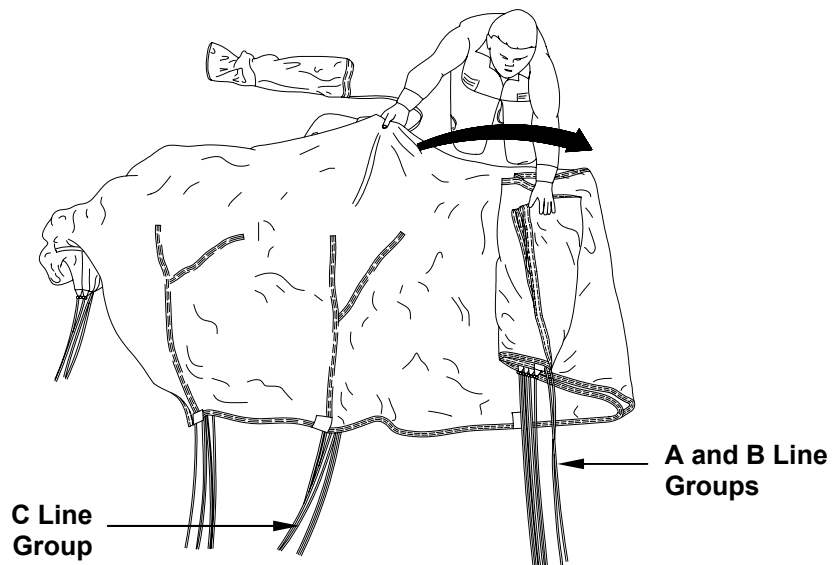

10. Holding all high points together in line with D line group, make an S-fold placing D line group on top of A, B, and C line groups. Ensure high points are kept taut.

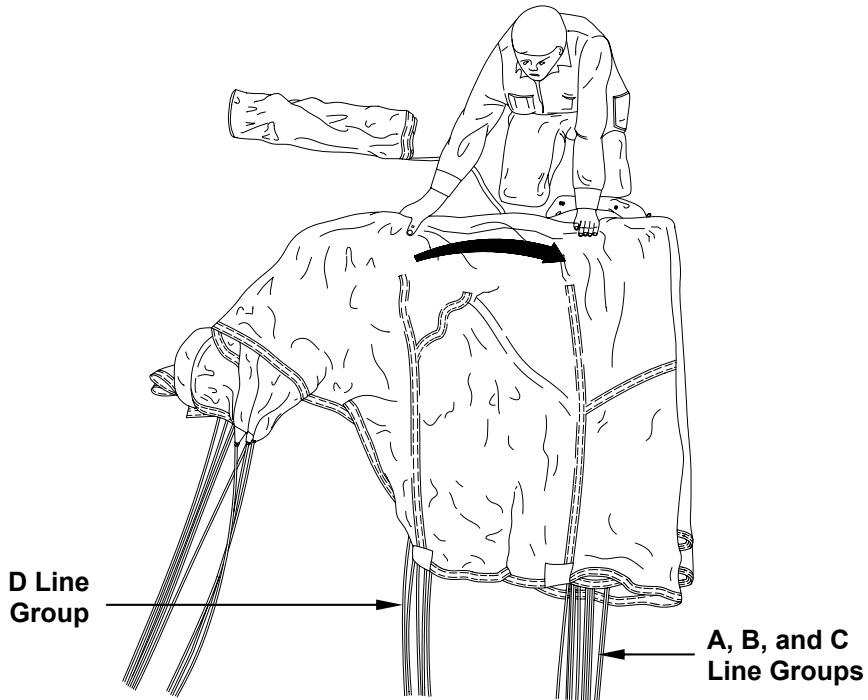

11. With right hand on top of all folds, reach under and pull slack out of D lines.

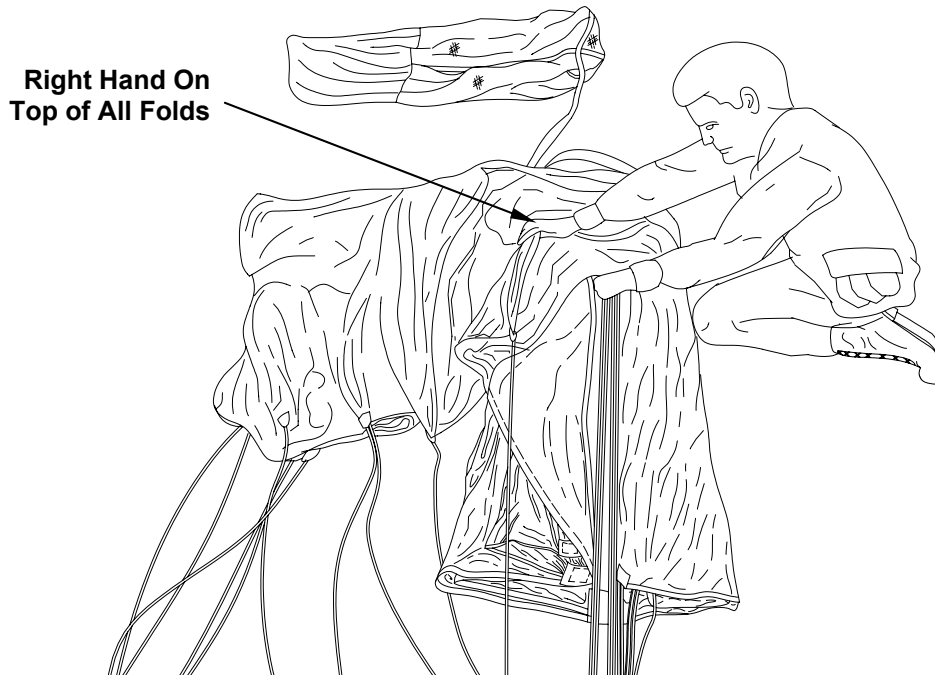

12. Holding line groups together, pull out and straighten the three stabilizer panels on the right side. The third stabilizer is inside the second stabilizer. Ensure tape is visible and no stabilizer panel is in a line group.

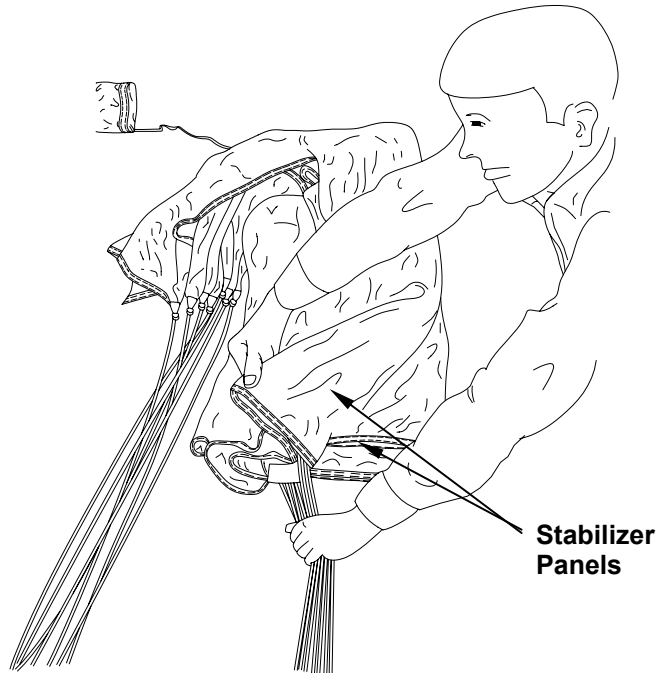

13. Holding line groups together, pull out and straighten the three stabilizer panels on the left side; the third stabilizer is inside the second stabilizer. Ensure tape is visible and no stabilizer panel is in a line group.



**SETTING DEPLOYMENT BREAKS:**

Set deployment breaks as follows:

1. Open control line keeper. Pull control line down until finger-trapped loop is through control line guide ring.

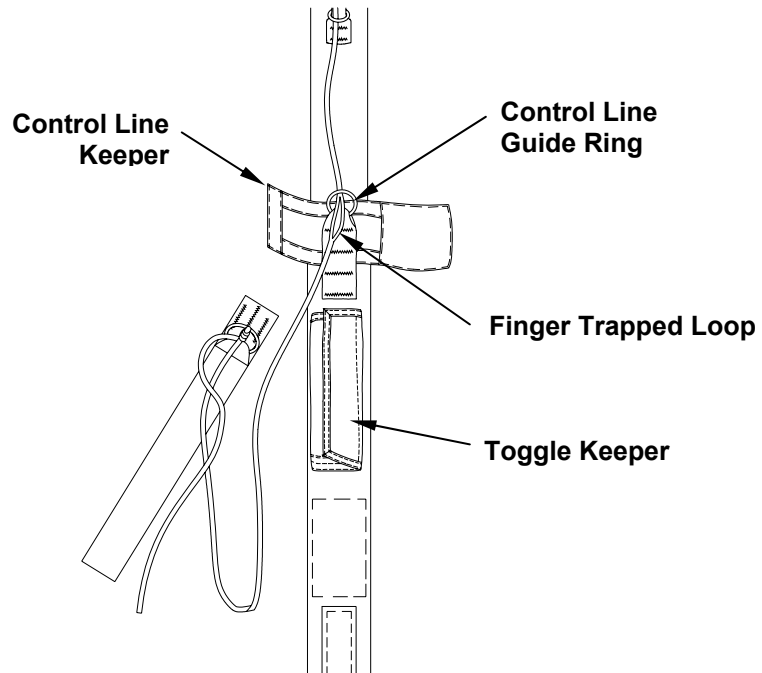

2. Insert top of control toggle through loop 1-inch.

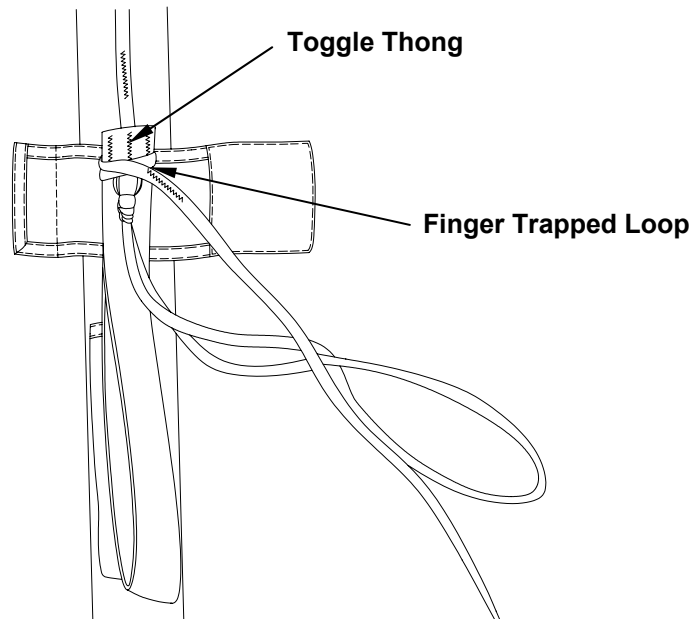

3. S-fold control line and neatly stow excess line along side each ring, ensuring that no folded loops extend above or below excess control line keepers. Ensure that excess line is to the right (pile) side of the keeper. Close excess control line keepers.

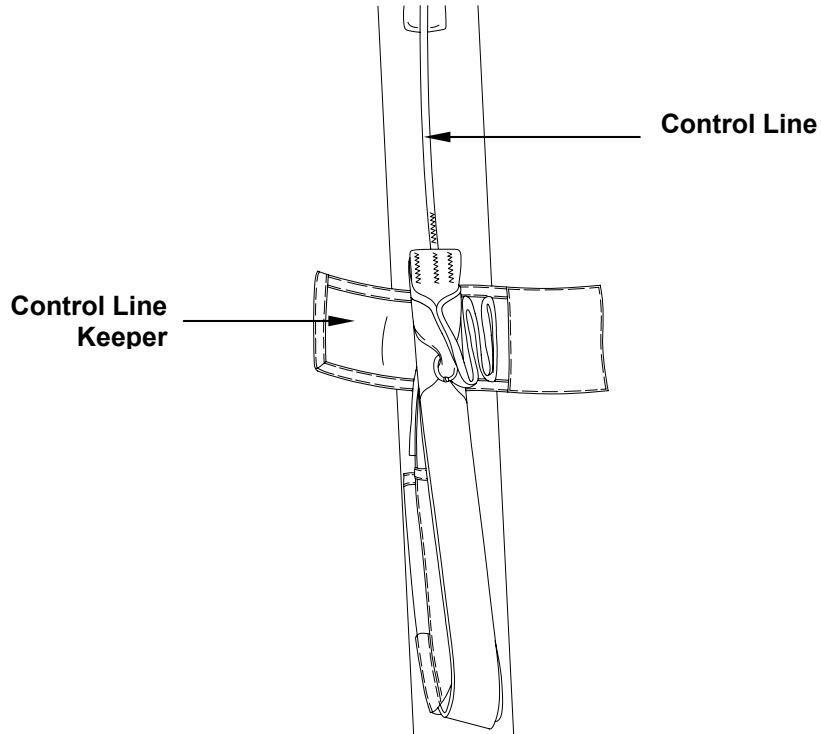

4. Close toggle keepers, enclosing only bottom portion of each toggle.

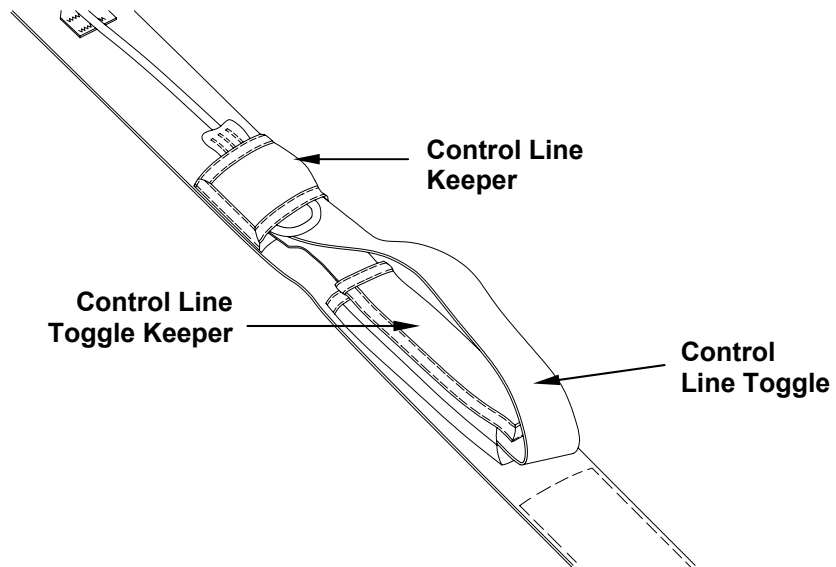

**NOTE**

Steps 5. through 12. provide installation instructions for optional toggle extenders.

5. Thread attaching loop end of toggle extender down through keeper attaching loop.

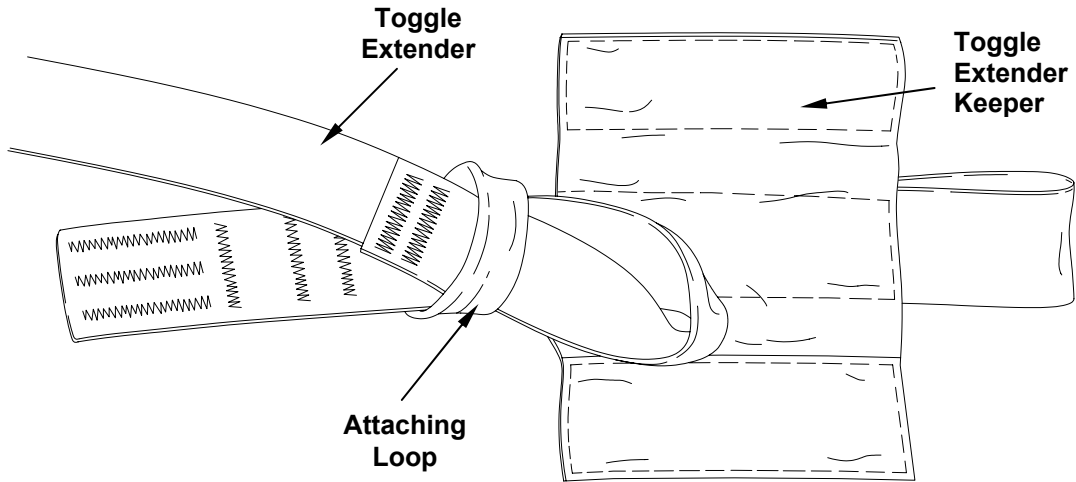

6. Thread hand loop end of toggle extender through toggle extender attaching loop and pull tight, forming a girth hitch. Ensure a smooth, flat knot is achieved.

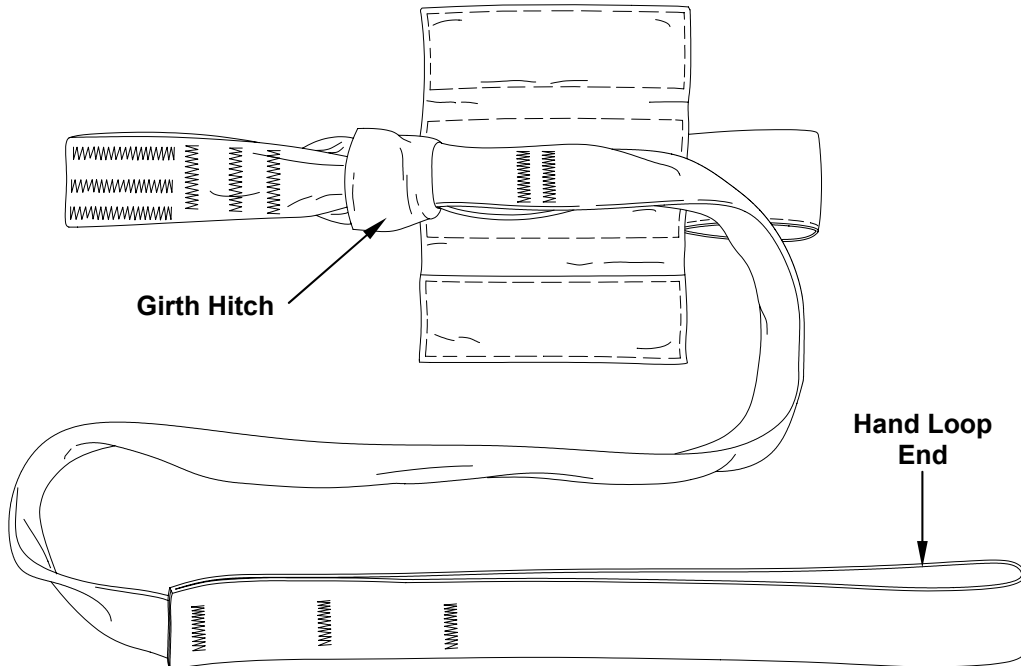

7. Ensuring that there are no twists, fold hand loop end of toggle extender towards locking end of toggle, aligning bartack number 1 with bottom edge of toggle keeper.

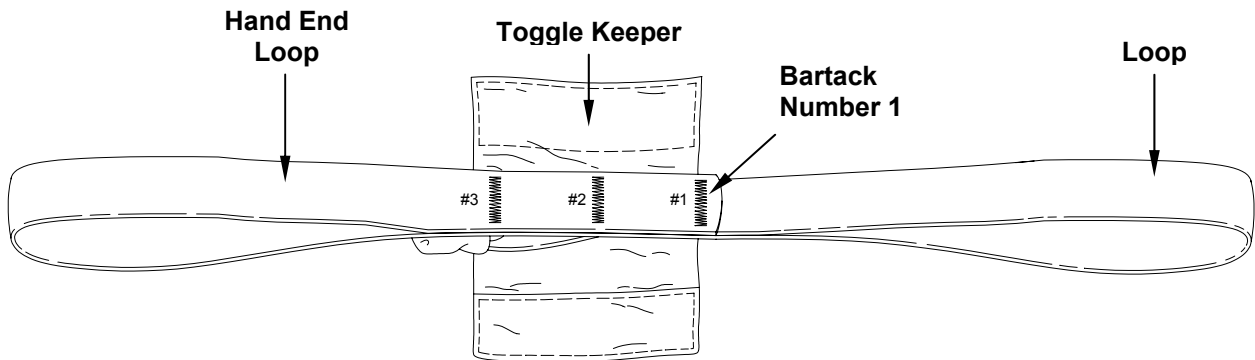

8. Make another fold by folding hand loop in half towards bartack number 1.

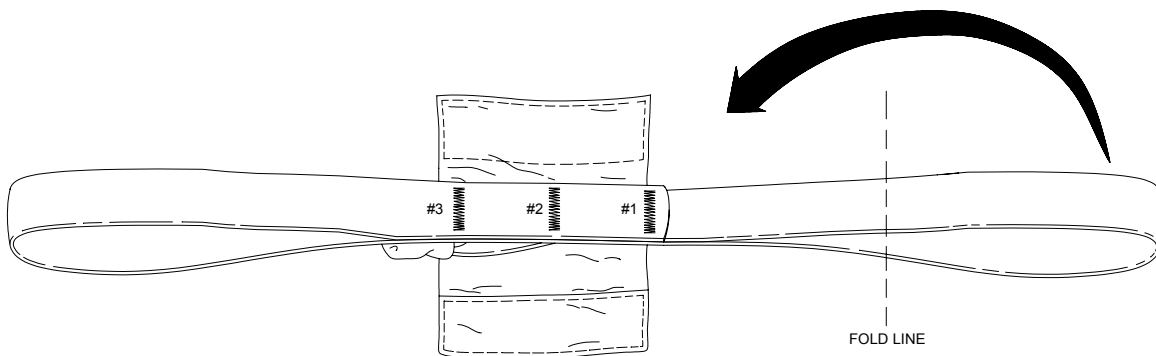

9. Make third fold towards bartack number 3, ensuring fold line is even with bottom edge of toggle keeper.

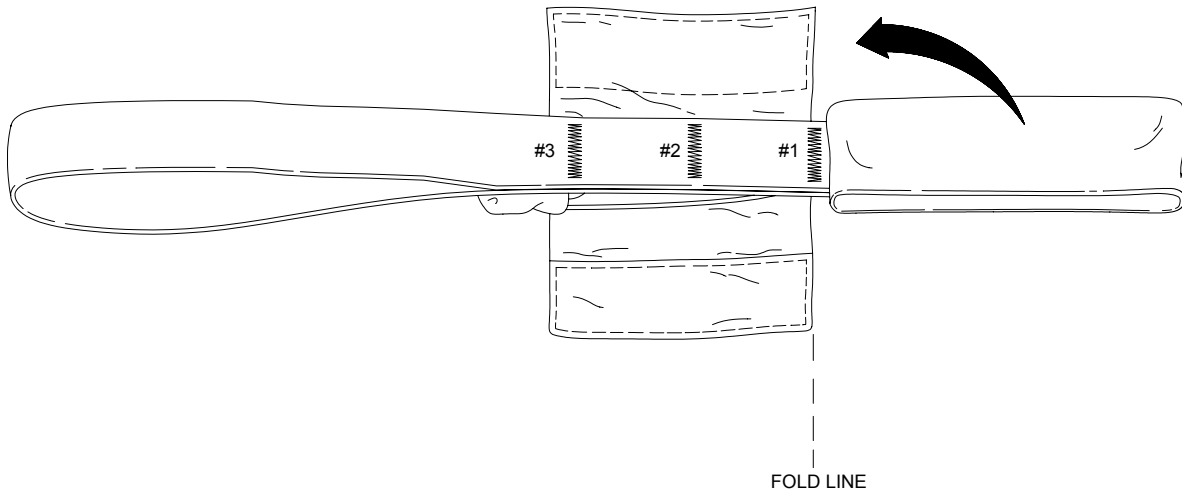

10. Fold other loop end of toggle extender on top of previous folds.

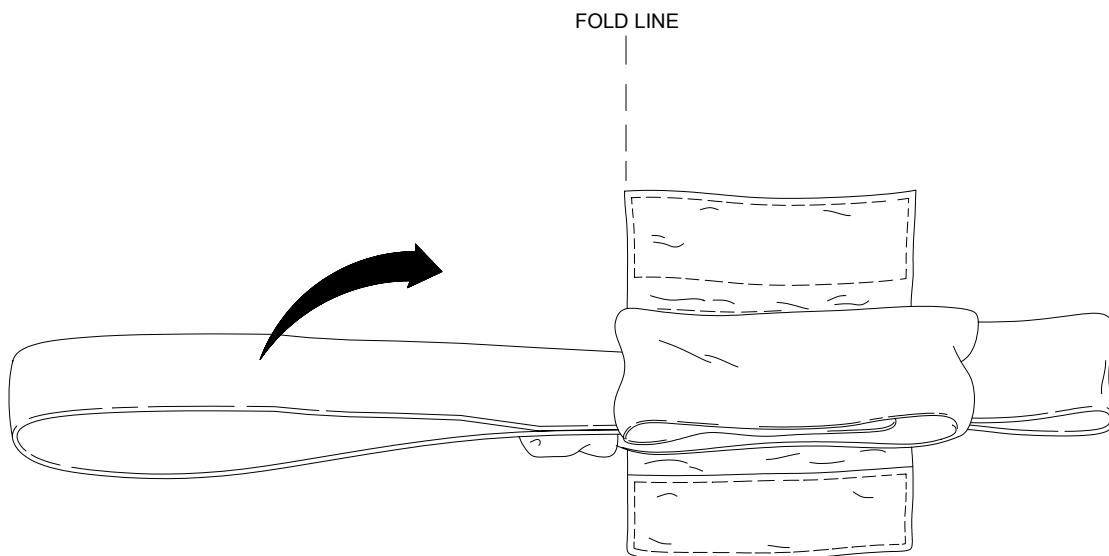



11. Ensure that all folds are tight and without twists. Close hook and pile fastener tapes of toggle extender keeper. Tack top and bottom of keeper closed with one turn cotton 24/4-cord, double. Tack through both thicknesses of keeper and one layer of the folded toggle extender.

**Tacking**

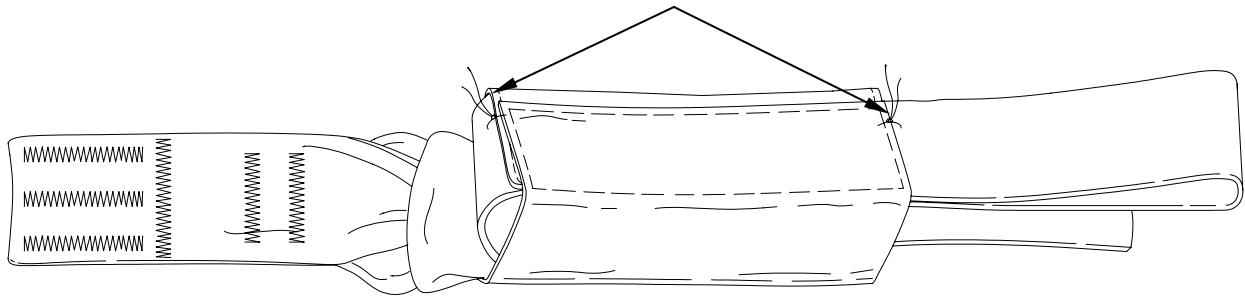

12. Stow the installed toggle extenders in the same manner as the control toggles are installed in steps 1. through 4.

**TAIL FOLDING**

Fold tail as follows:

1. Grasp uppermost control line and pull taut. Place control line on top of line groups A, B, C, and D. Fold tip portion of stabilizer panel to the right.

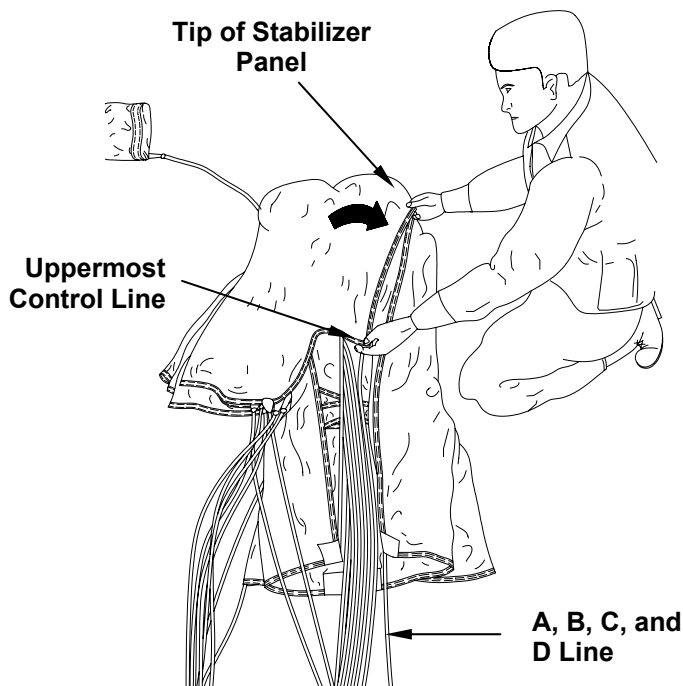

2. Continue to place each control line in this group on top of line groups A, B, C, and D. Fold the panel between each control line to the outside. Keep lines taut.

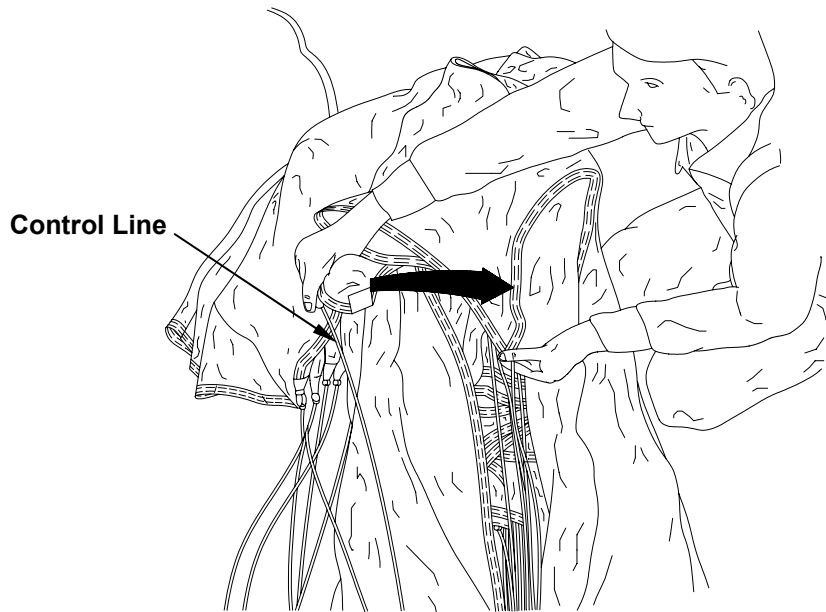

3. Continue folding center of tail by placing seams to the center of canopy and folding panels to the outside.

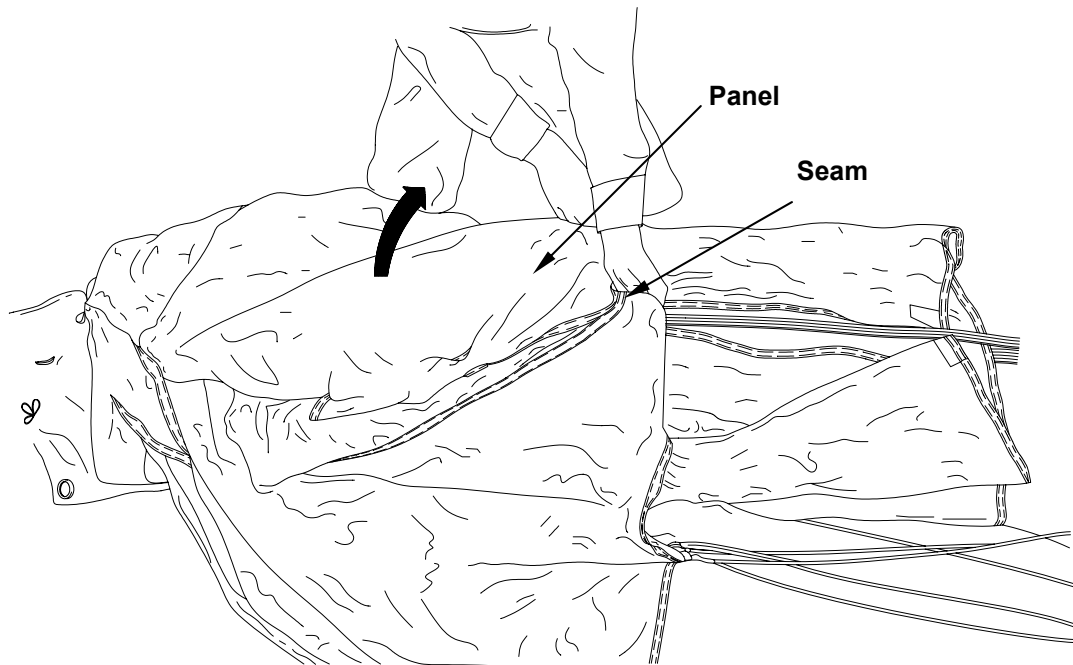

4. Place control lines on other side of canopy on top of suspension lines and fold panels to the outside in the same manner as first control line group. Keep control lines taut at all times.

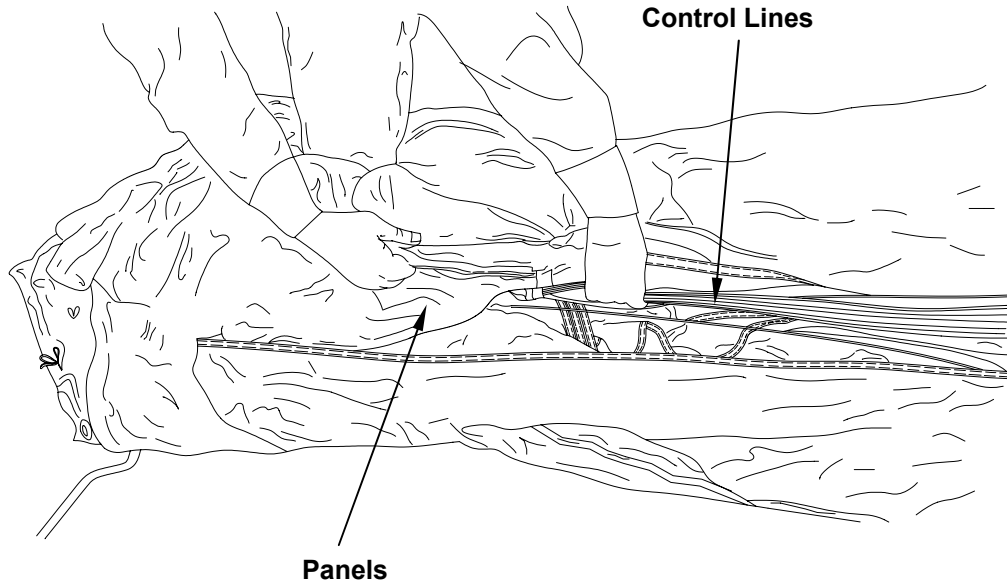

5. When opposite side is reached, pull stabilizer panel to the outside and pull slack out of control lines.

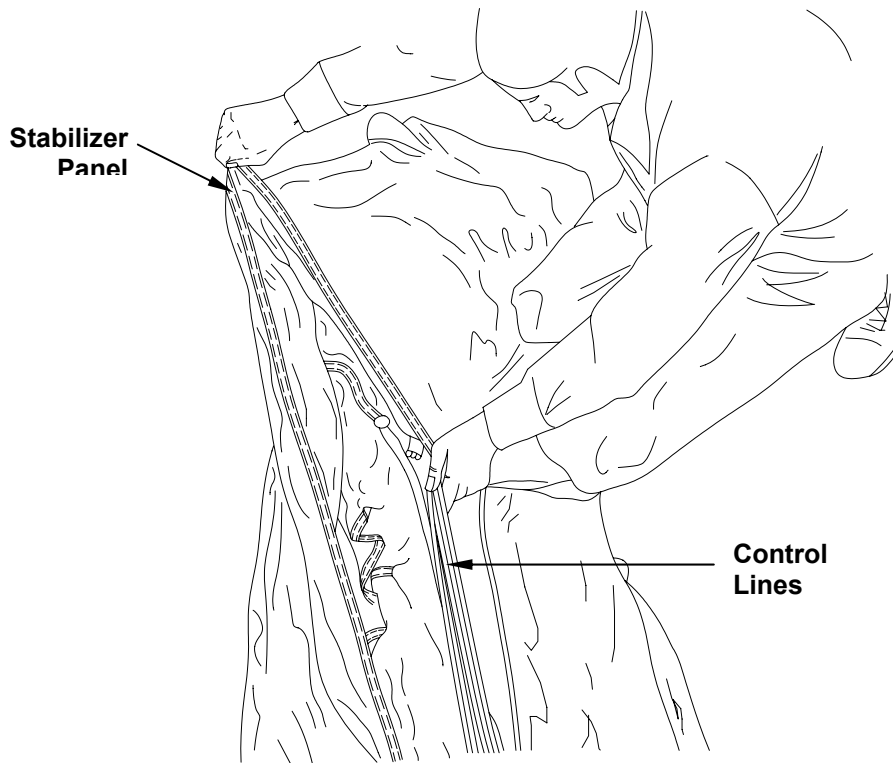

6. Find center tab on trailing edge. This tab indicates center of canopy. Fold half of folded tail back.

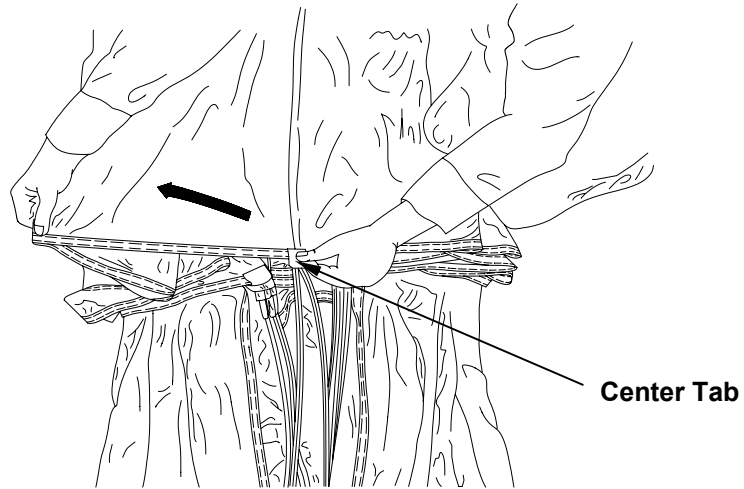

7. Gather and count the ten control lines and the two groups of eight each A and B and C and D lines. Situate them neatly in the center of the canopy.
8. Keep tab in center of canopy. Check that control lines are taut and in the center of canopy. Spread center of tail one full section left and right of center tail.

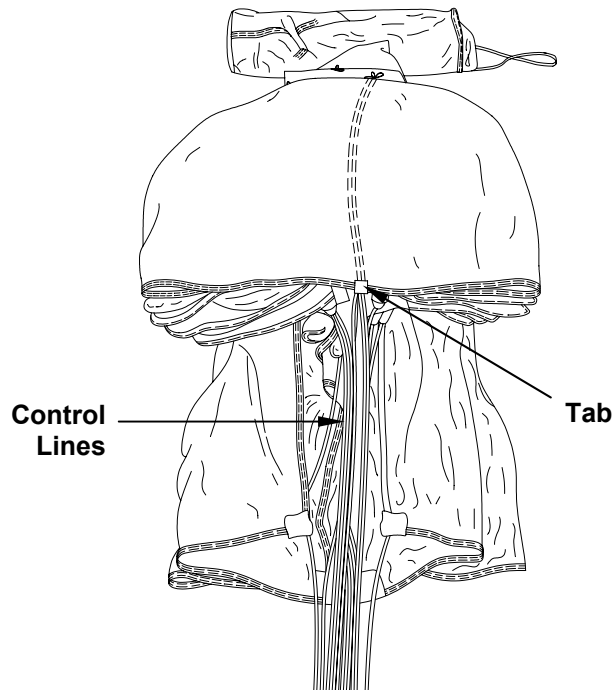

9. Fold center tail panel around canopy until it is the approximate width of deployment bag. Smooth out trapped air until canopy lies flat. Keep control lines in the center.

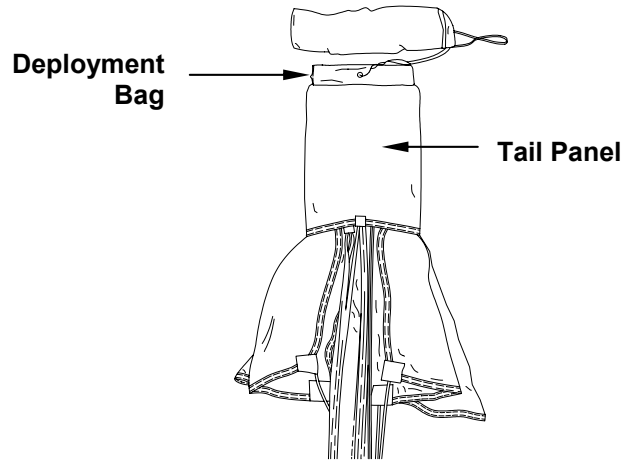

10. Place rear riser line groups to the outside of front riser line groups. Lay slider down flat between line groups, with reinforcement tape facing up. Ensure each line group from the canopy enters slider grommet from the top and exits out underneath slider.
11. Grasp slider by top center, ensuring that reinforcement tape appears on the topside toward the canopy. Bring slider up to bottom of canopy, ensuring free movement along suspension lines.

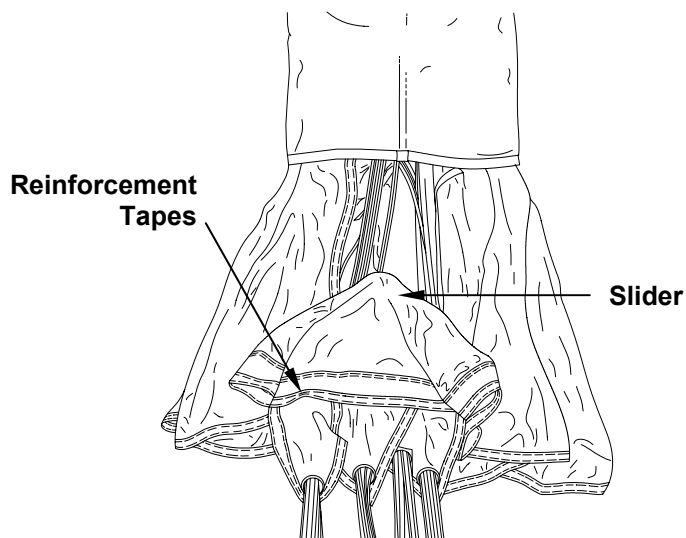

12. Rigger check number 2.

13. Fold left stabilizer panels, then right stabilizer panels over slider.

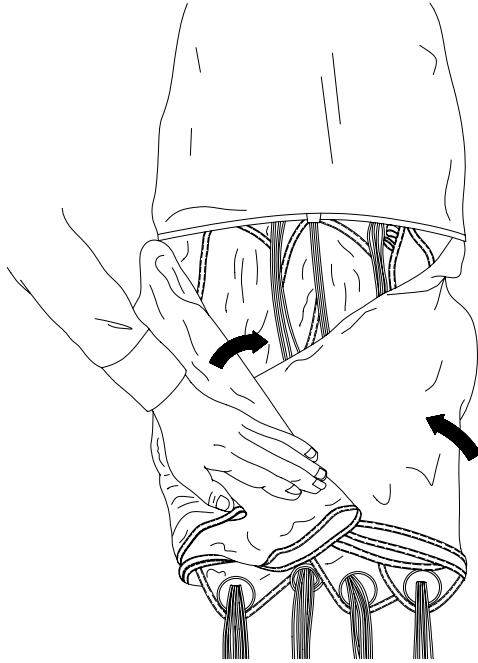

14. Place hand on canopy approximately 10-inches from suspension lines. Grasp canopy at suspension lines in preparation for making the first fold.

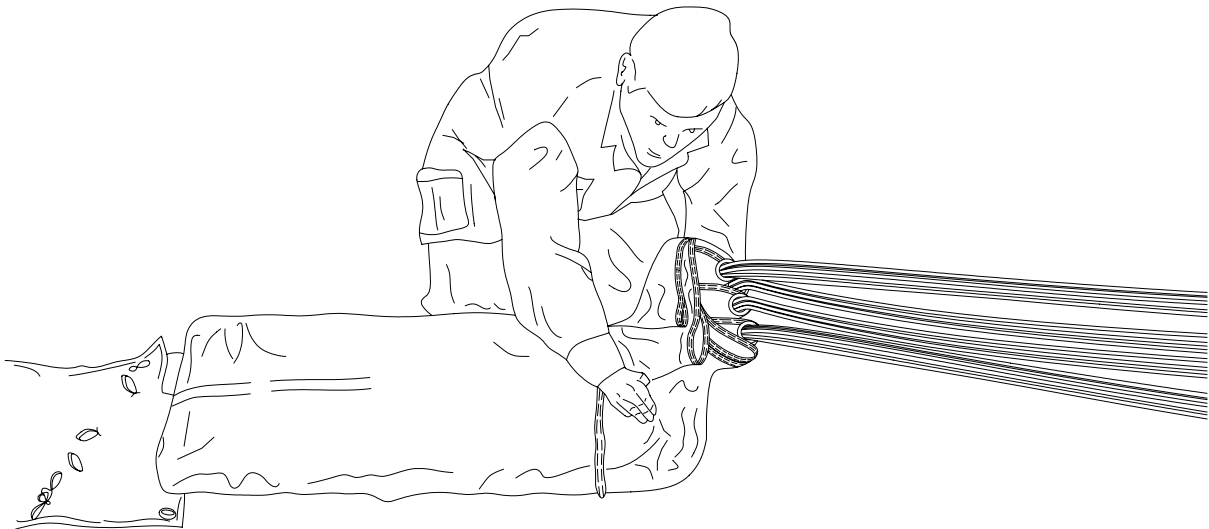

15. S-fold suspension line end toward deployment bag end. Maintain an approximate 10-inch fold.



16. Place hand firmly on canopy at suspension line end. Place other hand under canopy approximately 10-inches from end of first S-fold.

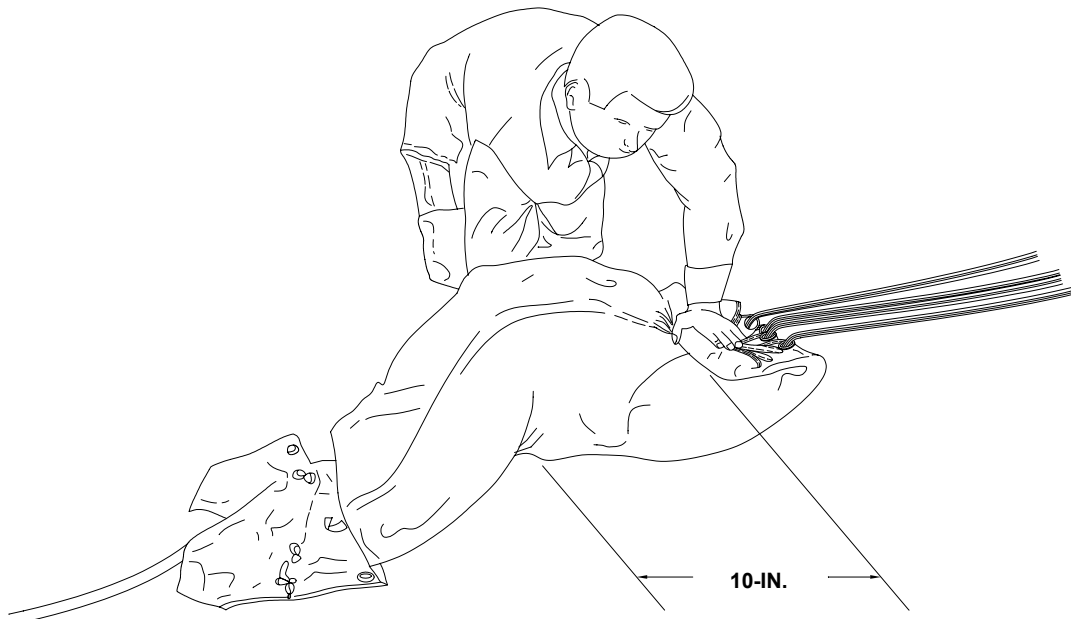

17. S-fold deployment bag end toward suspension line end. The top of the canopy must be rolled/folded under to clear the bridle loop attaching point (metal ring).
18. Maintain a finished fold approximately the width of the deployment bag.

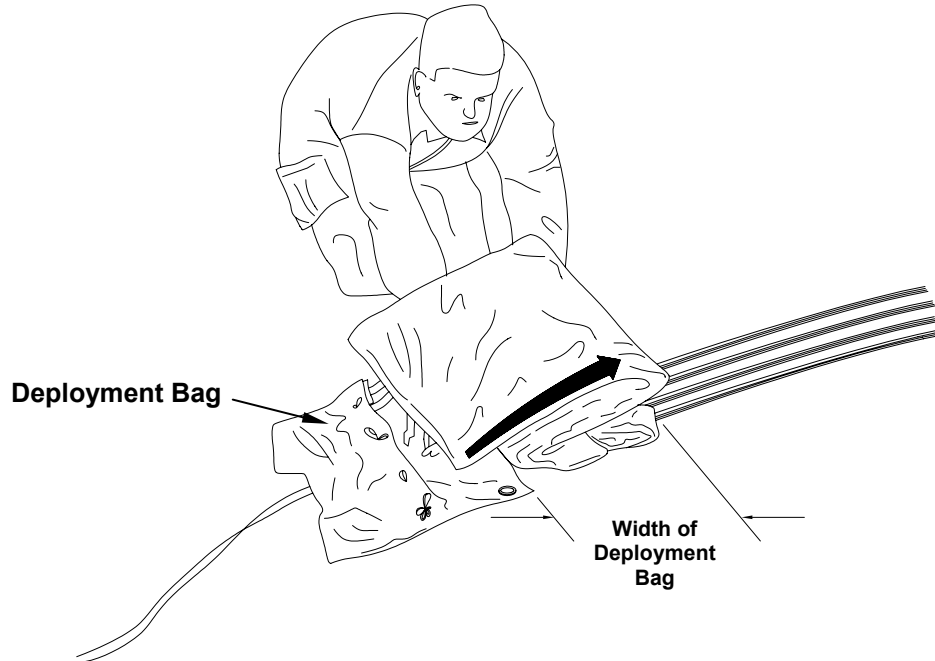

#### **STOWING CANOPY IN DEPLOYMENT BAG**

Stow canopy in deployment bag as follows:

1. Place one knee on folded canopy. Smooth out canopy removing all trapped air. Begin to pull deployment bag over canopy.

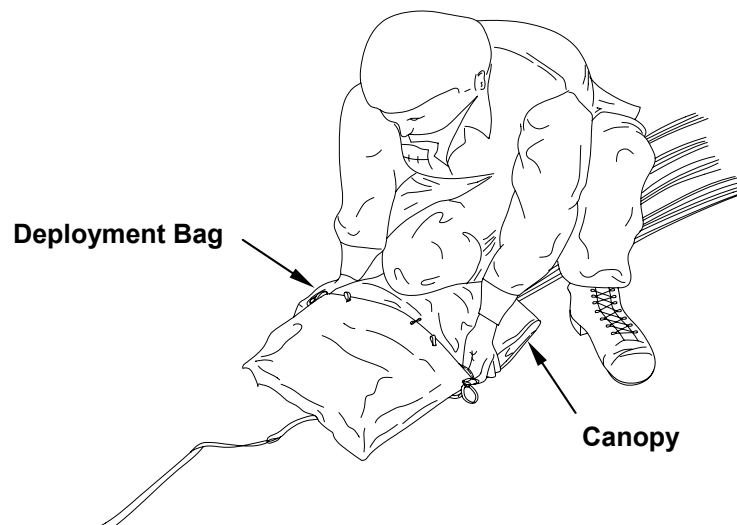



2. Fully insert canopy into deployment bag. Work canopy into corners of bag. Remove slack in bridle line until attachment ring on canopy is flush with grommet on bag. Clear any visible canopy material from bridle.

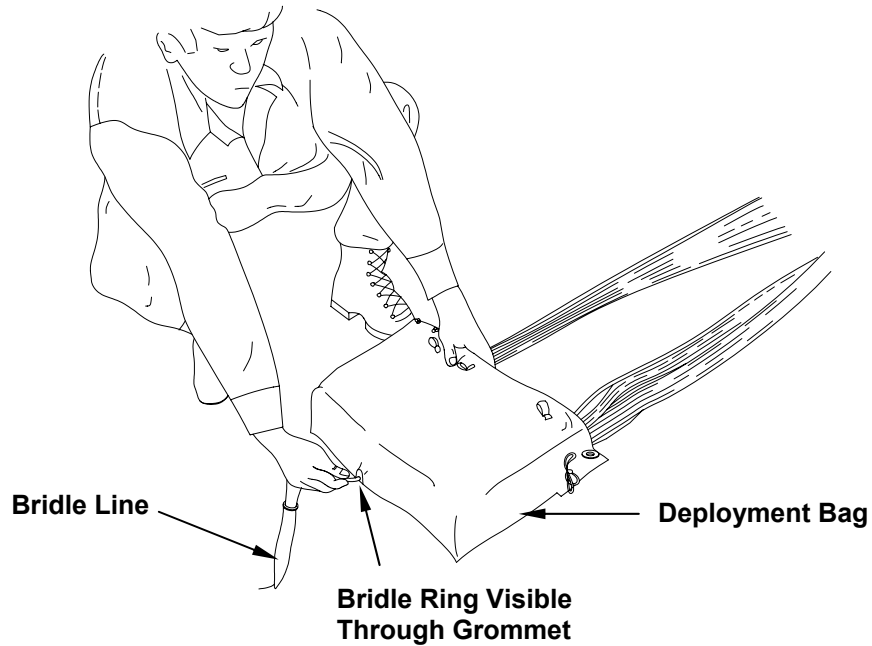

### STOWING SUSPENSION LINES

Stow suspension lines as follows:

1. Starting with center two grommets, close locking flap by passing heavy-duty retainer bands through grommets. Make first suspension line locking stow on right side. Lines will extend through retainer band 1-inch at each stow.

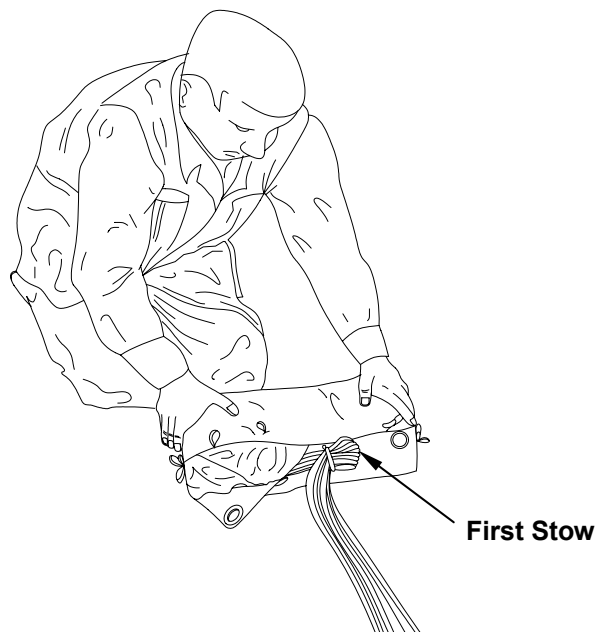

2. Make second suspension line locking stow in retainer band opposite first stow on the left stow.

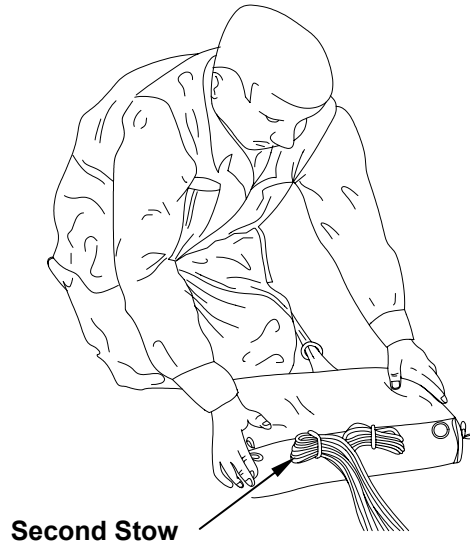

3. Finish locking deployment bag by passing retainer bands through the two outboard grommets, then make third and fourth suspension line locking stows.

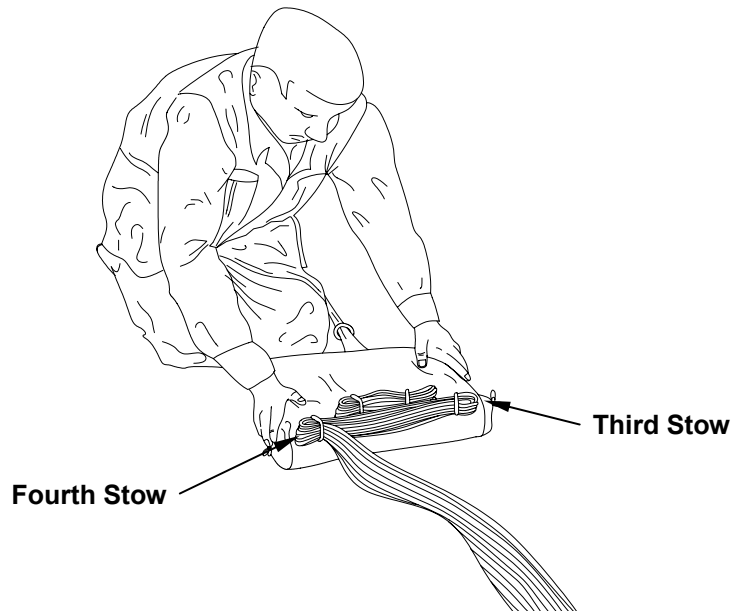

4. Rigger check number 3.

5. Continue to stow suspension lines, alternating stows in right and left retainer bands until approximately 12-inches of lines remain.

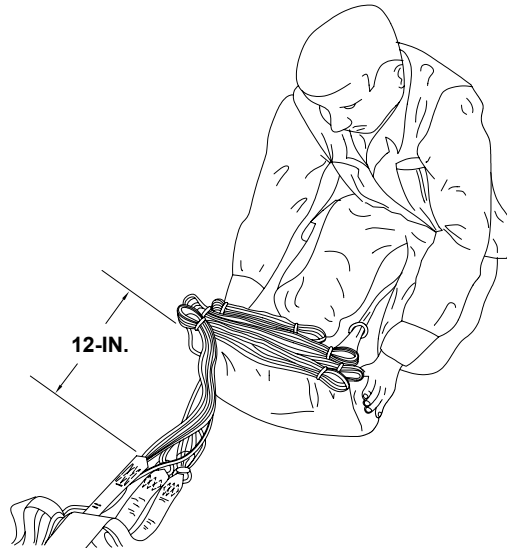

6. Rigger check number 4.

### CLOSING CONTAINER

Close container as follows:

1. Insert pull-up cord through loop in main closing loop.

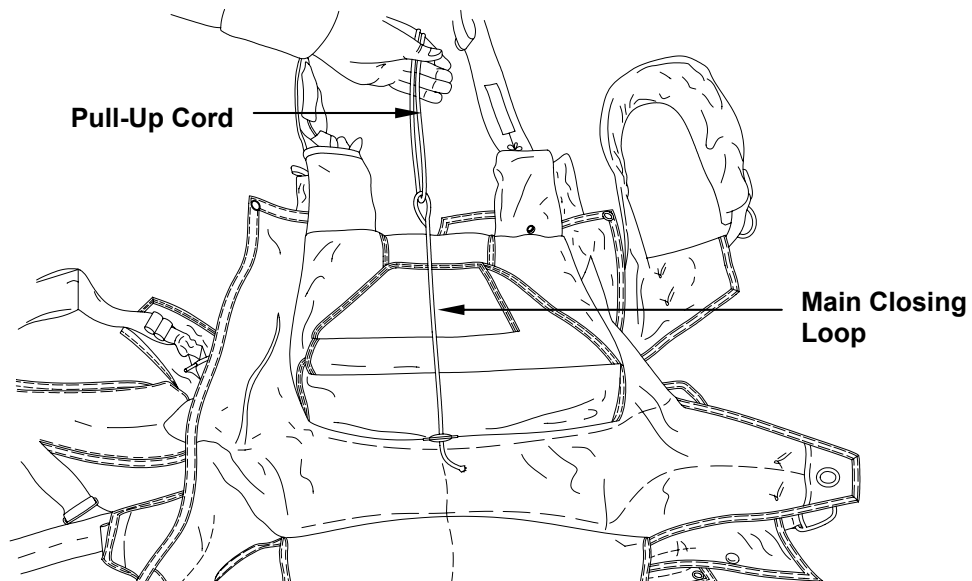

2. Rotate deployment bag and suspension lines over container. Position risers along sides of reserve parachute container, continuing along sides of main container, with control toggles facing inward.

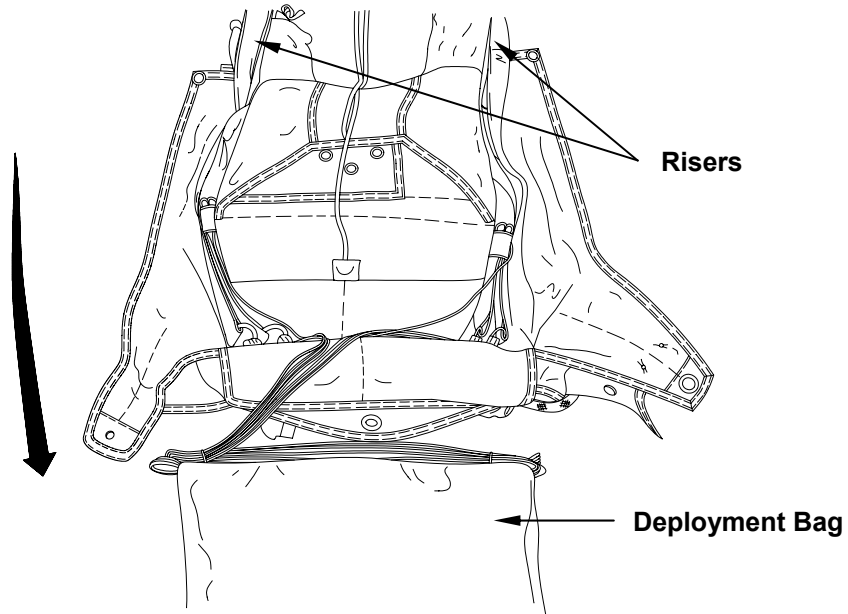

3. Position deployment bag and suspension lines into container. Position suspension lines so they face bottom of main parachute container. Route bridle line out over reserve chute.

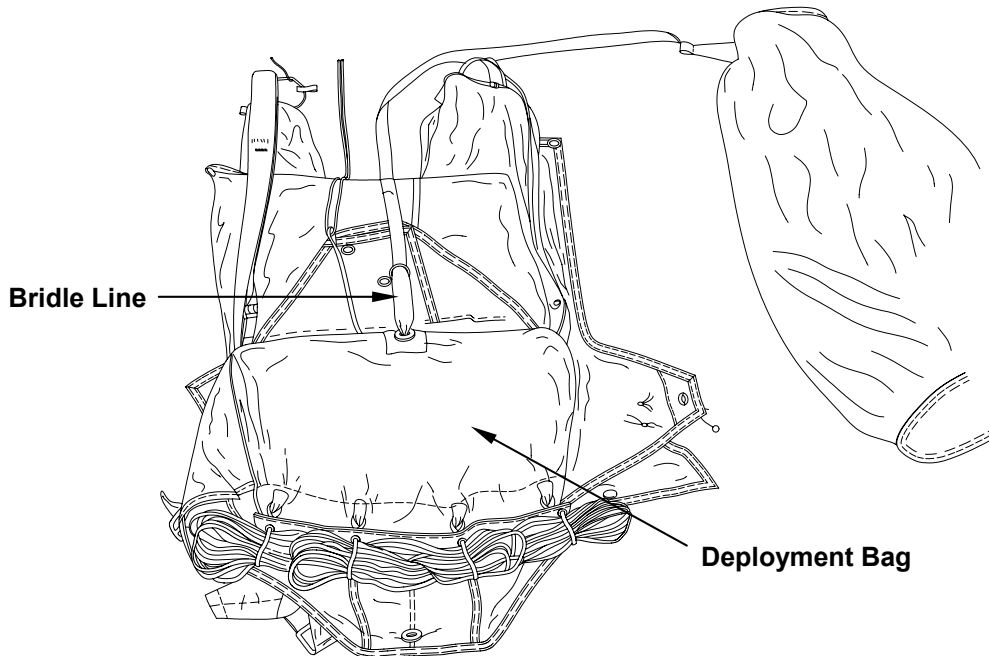

4. Fold bridle line on top of deployment bag no wider than spring of pilot chute.

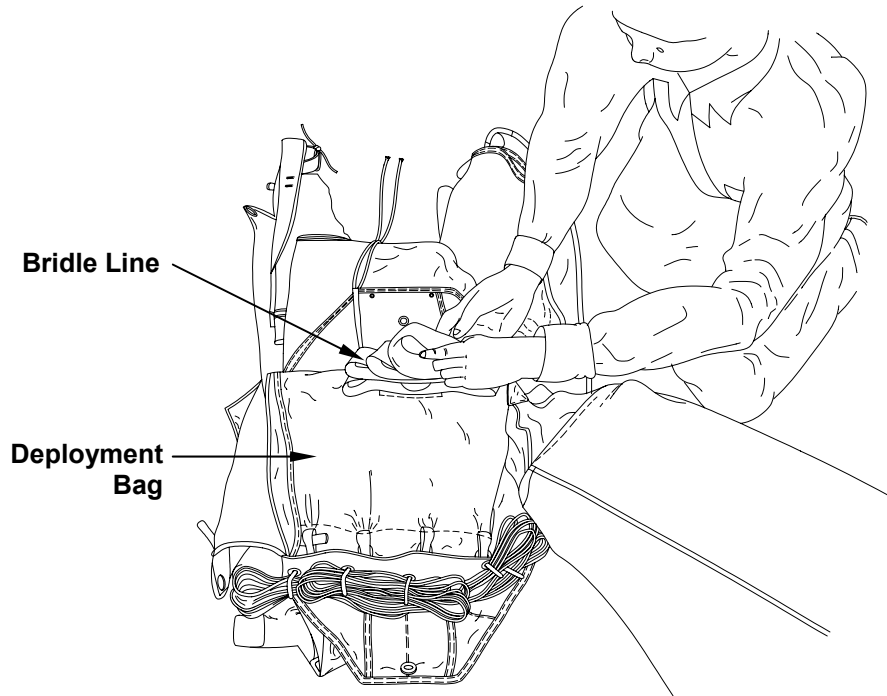

5. Position pilot chute on center of deployment bag over folded bridle. Grasp pilot chute and gather in canopy material.

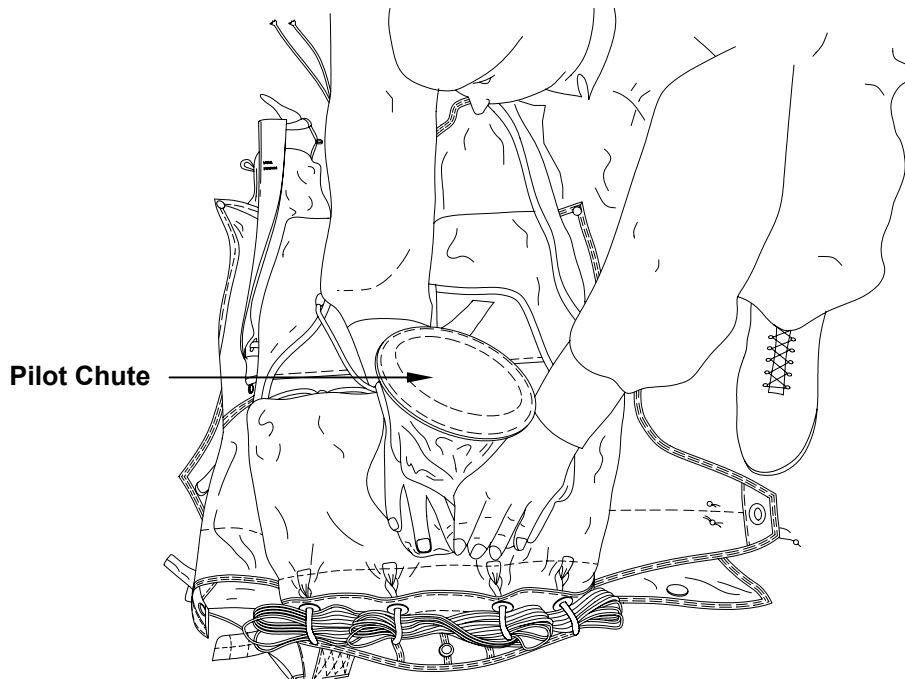

6. Compress pilot chute. Place knee on compressed pilot chute and route pull-up cord over pilot chute crown and through grommet on bottom flap. Using pull up cord, pull main closing loop up through grommet and insert temporary locking pin.

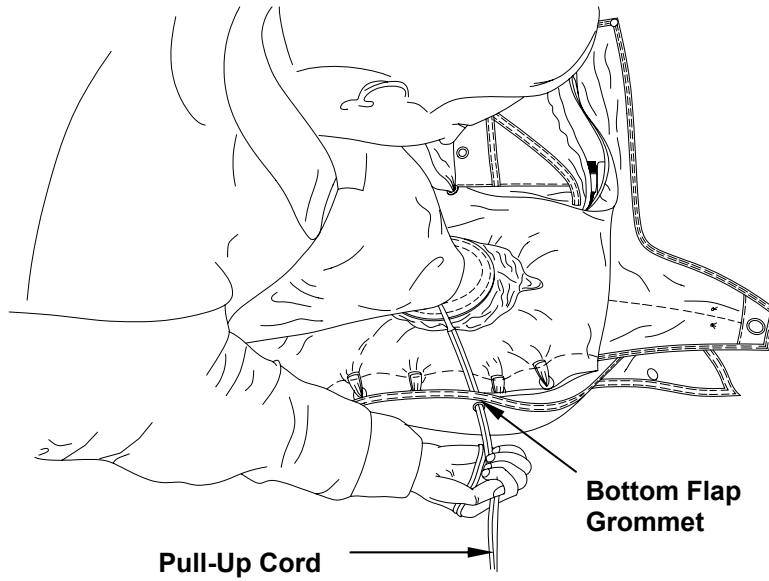

7. Route pull-up cord through grommet in left side flap, right side flap, and top flap. Use temporary locking pin after securing each flap.

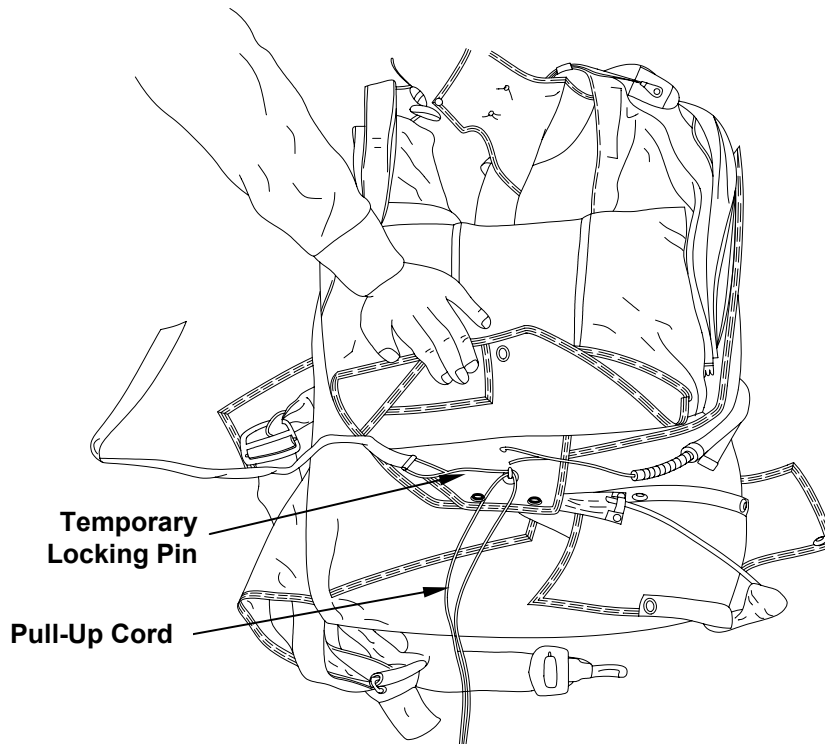

8. For main mounted AR2s, pull up and remove temporary locking pin and thread eye of power cable over ripcord locking pin. Insert ripcord pin into main closing loop (detail A). Axis of ripcord pin will follow the angled hole in the eye of the power cable (detail B). Center straight portion of ripcord pin in closing loop and ensure that shoulder of pin remains outside of grommet.

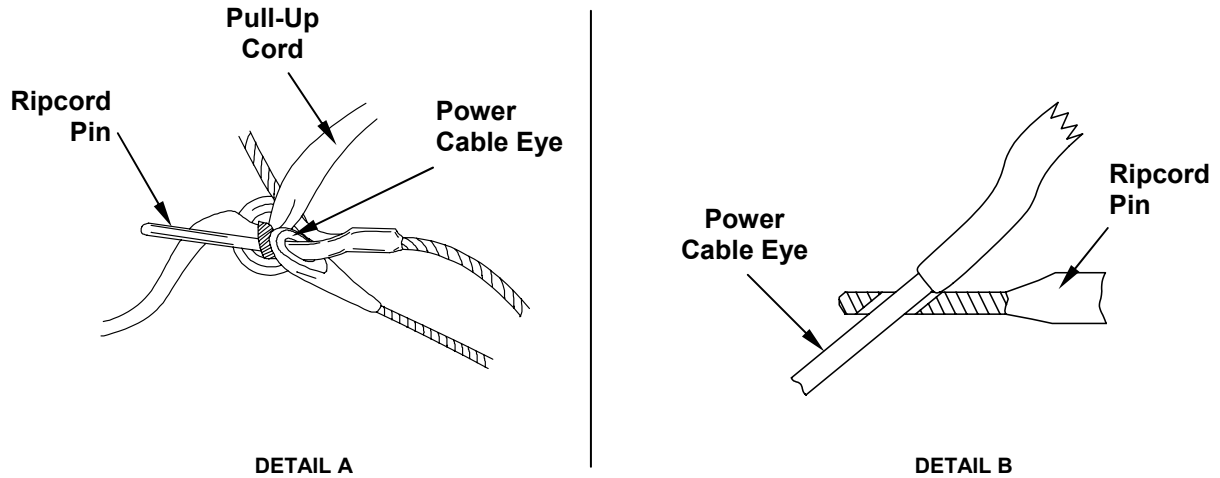

**NOTE**

The following Ripcord Pull Tests are performed on all MC-4 systems on a one-time-only basis.

9. Place parachute in test fixture or anthropometrical device (torso) simulating the 5-to-95 percentile person or live subject. The device shall hold parachute securely in a position with the mouth of the ripcord pocket facing down (along vertical axis).
10. Rotate harness/container so that open end of ripcord housing faces down with ripcord cable in a vertical position.

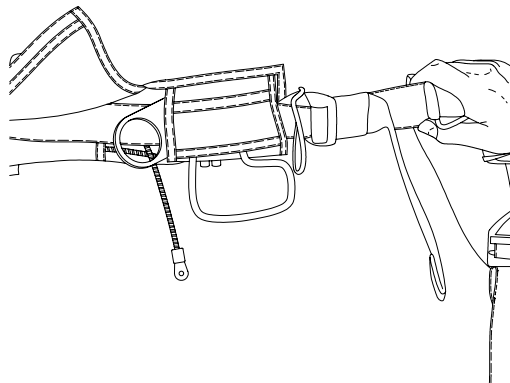

11. Secure ripcord handle by hand to prevent ripcord pin withdrawal when weight is applied.

12. A 20-pound weight attached to the center of the ripcord grip (care shall be exercised not to impose an impact load) shall readily withdraw ripcord grip from pocket.

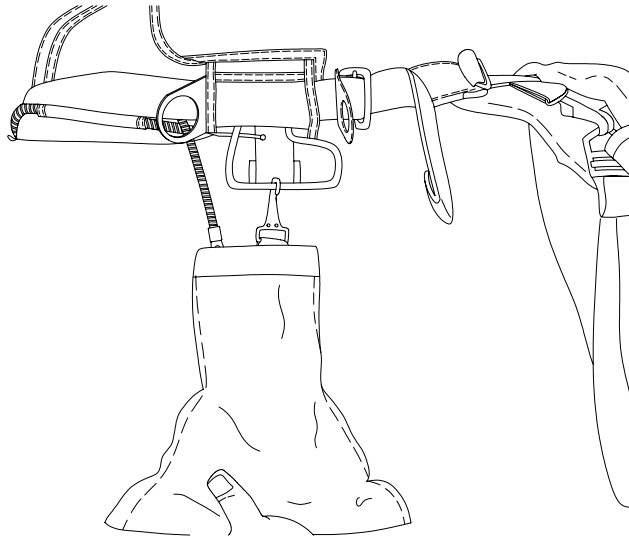

13. When ripcord grip has been removed from pocket, carefully remove the 20-pound weight.

**NOTE**

The following ripcord pull test and the stroke simulator test are performed on all MC-4 systems each time the main parachute is initially placed in service and when the main closing loop is replaced.

14. Attach a 27-pound weight to ripcord grip. Slowly remove your hand. The weight shall readily activate the parachute by withdrawing the ripcord pin from locking loop.

**NOTE**

It is not necessary to start the pack process over again if the same initial packer is conducting the Ripcord Pull Tests. If a different Parachute Rigger has taken over any of the tasks associated with the Ripcord Pull Tests, then a complete re-pack of the main parachute is required.

**NOTE**

Re-closing the container after the ripcord pull test does not constitute a repack toward the normal repack cycle (120-days).

15. Re-close the container IAW the procedures detailed above. Reinsert the ripcord pin-threading pin through eye of power cable.



**STROKE SIMULATOR TEST**

Conduct a Stroke Simulator Test for the MC-4 with a Main Mounted AR2 as follows:

**WARNING**

The Stroke Simulator must be able to pull the main ripcord pin positively and completely to ensure adequate travel of the AR2 power cable. Inadequate travel of the AR2 power cable may cause the parachute to not deploy, resulting in serious injury or death of the parachutist.

**NOTE**

The Stroke Simulator Test (power cable length of travel) will be performed each time the main parachute is initially placed in service, each time the main parachute is packed, each time a power cable is installed on the harness/container, when the AR2 has actuated during a jump, and whenever the main closing loop has been replaced.

**NOTE**

If ripcord pin fails to pull completely, check the length of the main closing loop, condition of the Navy stiffener, power cable housing and routing of power cable assembly.

1. Test routing and installation of the power cable assembly in the parachute harness/container while the harness/container is being worn in the normal fashion.
2. Connect stroke simulator to power cable assembly in place of the AR2.
3. Firmly hold stroke simulator adjacent to the AR2 pocket in a vertical orientation (i.e. stroke simulator plunger pointing down).
4. With assistance from another individual, carefully attach a 33-pound weight to the stroke simulator plunger and very slowly remove your hand from under the weight to allow the weight to be slowly transferred to the stroke simulator.
5. The weight must completely withdraw the ripcord pin within the available stroke.
6. Maintain control of the main pilot chute in an effort to prevent the entire contents of the main parachute from falling to the floor.
7. If the 33-pound weight hesitates or fails to pull the ripcord pins, remove and inspect the entire power cable assembly IAW WP 0046 00 of this technical manual, and TM 10-1670-305-23&P, WP 0019 00. If unserviceable, replace with a new item from stock, then repeat Stroke Simulator Test above. If the system fails a second time, it must be tagged and removed from service IAW WP 0011 00.
8. Detach stroke simulator from power cable.

**NOTE**

It is not necessary to start the pack process over again if the same initial packer is conducting the Stroke Simulator Test. If a different Parachute Rigger has taken over any of the tasks associated with the Stroke Simulator Test, then a complete re-pack of the main parachute is required.

**NOTE**

Re-closing the container after the stroke simulator test does not constitute a repack toward the normal repack cycle (120 days).

9. Reclose the container IAW the CLOSING CONTAINER procedures detailed above. Reinsert the ripcord pin-threading pin through eye of power cable.
10. At the completion of stroke simulator test, (if applicable) remove pull-up cord by routing underneath ripcord pin.

**NOTE**

Due to the continuous entries into the Parachute Log Record Book, authorization is granted to locally produce an internal tracking document that captures these required entries. If no such document exists, entries must be made into the Parachute Log Record Book.

11. After testing has been completed and the specified requirements are met, remove Parachute Log Record from log record pocket on underside of ripcord pin protector flap and make required entries. Reinsert log record into log record pocket. Close ripcord pin protector flap. Dress the container.

Conduct a Ripcord Pin Test for the MC-4 with a Main Mounted FF-2 as follows:

**WARNING**

The FF-2 must be able to pull the main ripcord pin positively and completely to ensure adequate travel of the FF-2 power cable. Inadequate travel of the FF-2 power cable may cause the parachute to not deploy, resulting in serious injury or death of the parachutist.

**NOTE**

The FF-2 Test (power cable length of travel) will be performed each time the main parachute is initially placed in service and whenever the main closing loop has been replaced. It is recommended that a "shop" FF-2 be utilized to withdraw the ripcord pins thus eliminating the over use of existing FF-2s.

1. Test routing and installation of the FF-2 in the parachute harness/container while the harness/container is being worn in the normal fashion.
2. Properly attach and secure an FF-2 by aligning rectangular key on end of power cable housing and insert in corresponding slot in base plate.

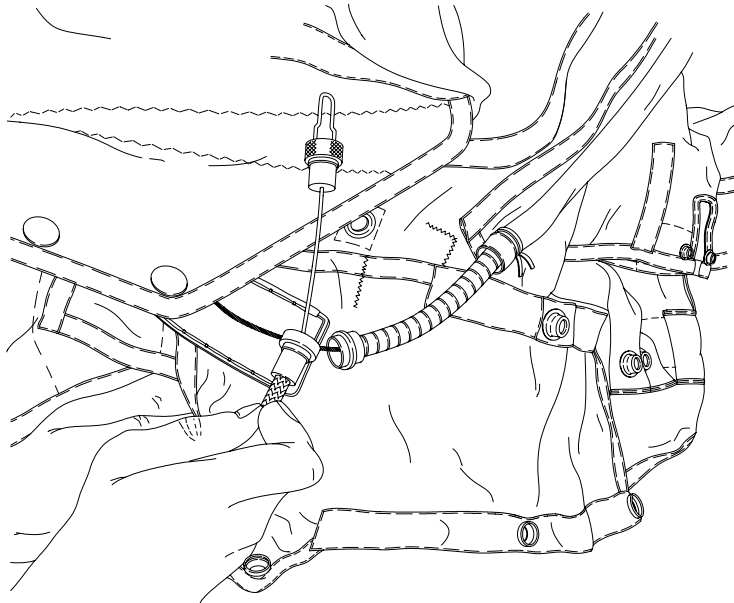

3. Turn housing 90 degrees counterclockwise and lock in place.

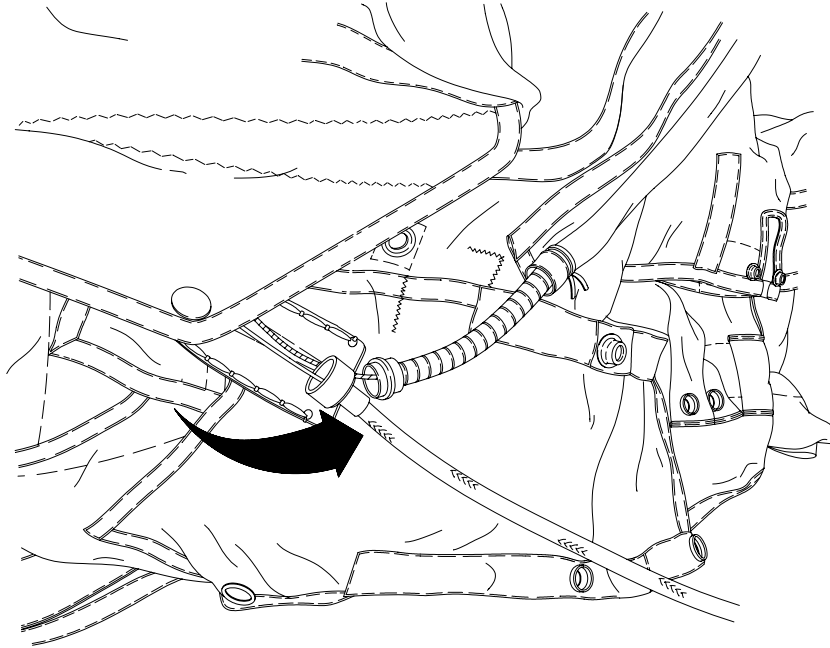

4. Insert FF-2 into FF-2 pocket.

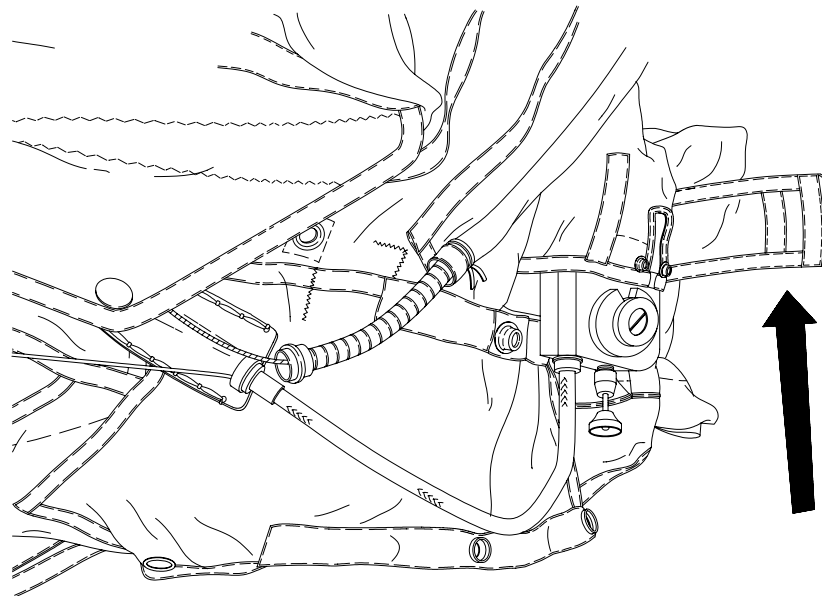

5. Mate snap fasteners on securing straps to fasteners on pocket.

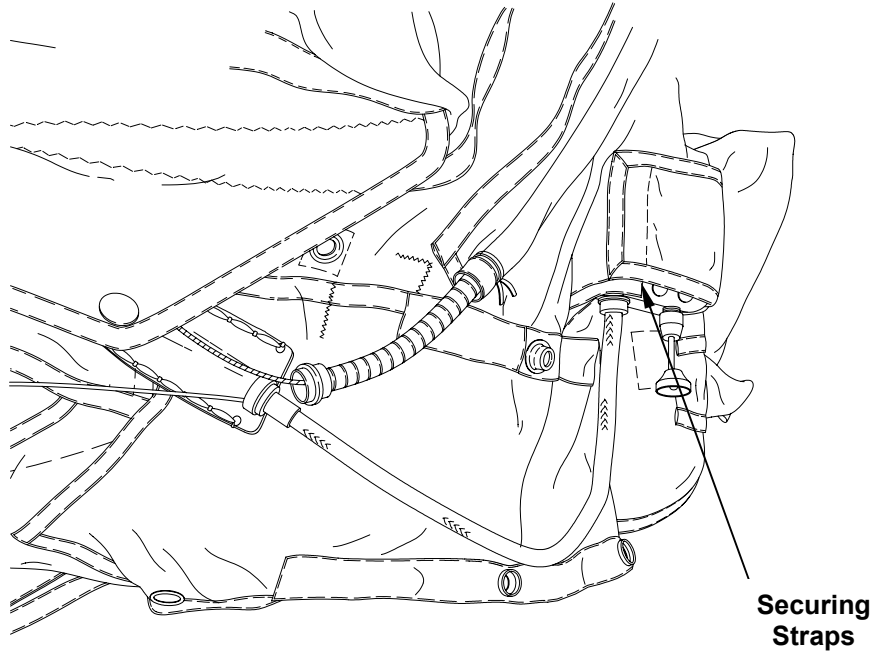

6. Unscrew the knurled locking nut on the power cable.
7. Place withdrawal hook around ripcord locking pin.
8. Place withdrawal hook in withdrawal hook retainer.
9. Tighten knurled locking nut finger tight.

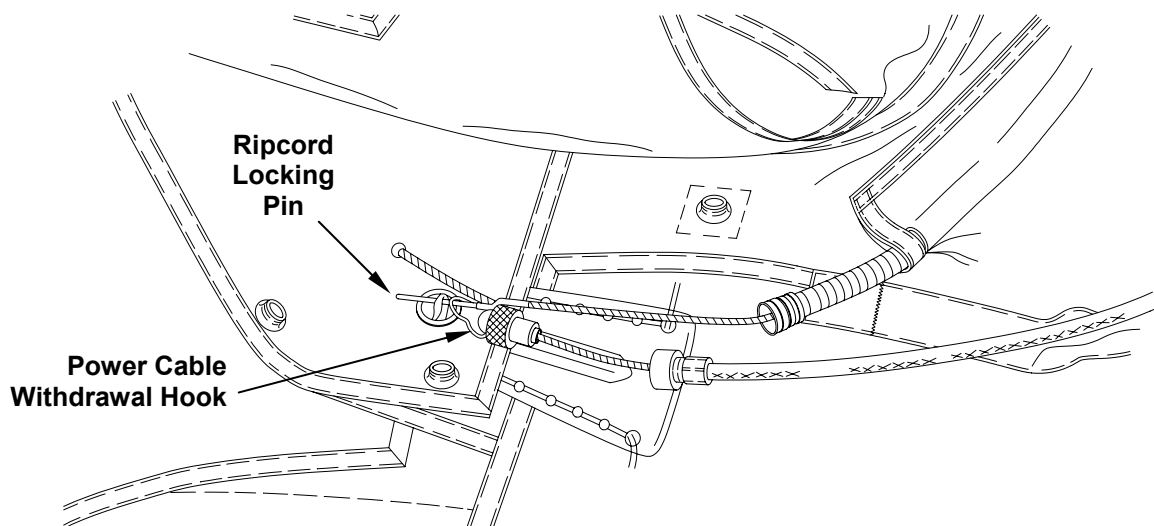

10. Activate the FF-2.
11. If the FF-2 fails to pull the ripcord pin, remove and inspect the length of the main closing loop and the entire FF-2 power cable assembly IAW TM 10-1670-300-20&P. Check to ensure the cable assembly is mounted properly to the base plate.
12. If unserviceable, replace with new items from stock, then repeat TEST procedures detailed above.
13. If the system fails a second time, it must be tagged and removed from service IAW WP 0011 00.

**NOTE**

It is not necessary to start the pack process over again if the same initial packer is conducting the FF-2 test. If a different Parachute Rigger has taken over any of the tasks associated with the FF-2 test, then a complete re-pack of the main parachute is required.

**NOTE**

Re-closing the container after the ripcord pin test does not constitute a repack toward the normal repack cycle (120-days).

14. Close the container IAW the CLOSING CONTAINER procedures detailed above. Reinsert the ripcord pin-threading pin through eye of power cable.
15. At the completion of ripcord pin test, remove pull-up cords by routing underneath ripcord pins.

**NOTE**

Due to the continuous entries into the Parachute Log Record Book, authorization is granted to locally produce an internal tracking document that captures these required entries. If no such document exists, entries must be made into the Parachute Log Record Book.

16. After testing has been completed and the specified requirements are met, remove Parachute Log Record from log record pocket on underside of ripcord pin protector flap and make required entries. Reinsert log record into log record pocket. Close ripcord pin protector flap. Dress the container.

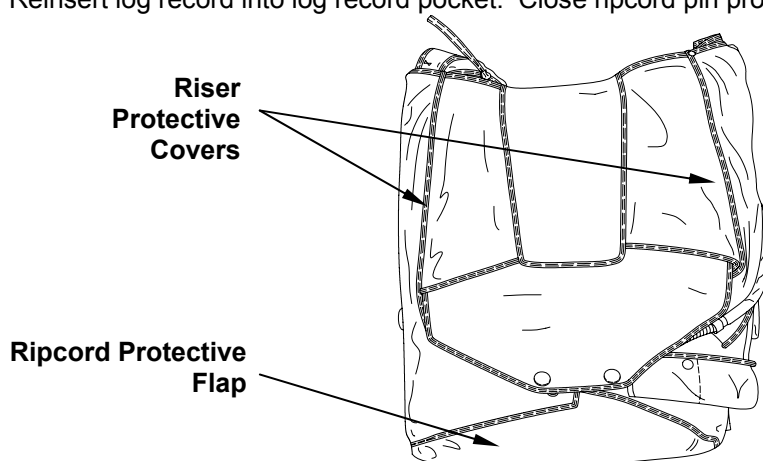

16. Rigger check number 5.

### **INSTALLING THE AUTOMATIC ACTIVATION DEVICE**

Install the automatic opening device as follows:

1. Install the Automatic Ripcord Release (AR2) as follows:

#### **WARNING**

When attaching the power cable assembly to the AR2, always verify proper engagement of ball end of power cable with piston rod of AR2 by looking through transparent plastic cable seal retainer. Cable seal retainer and power cable seal must be present to ensure correct seating of power cable ball. If ball is not engaged with piston rod or if cable seal retainer is missing, actuation of AR2 will fail to pull ripcord pins, which may result in death of parachutist.

#### **CAUTION**

Finger tighten the power-housing retainer. Do not use pliers or other tools that will over tighten power-housing retainer.

#### **CAUTION**

Ensure container is handled with care when transporting container with the AR2 installed. Failure to do so may result in damage to equipment.

#### **NOTE**

Make sure the AR2 is cocked, and the JUMP/OFF switch is set to OFF.

#### **NOTE**

Prior to installing the AR2 in the ripcord release pocket, remove the storage cable and piston rod cap, if present. Save these components for future use.

- a. Ensure that the AR2 JUMP/OFF switch is OFF.

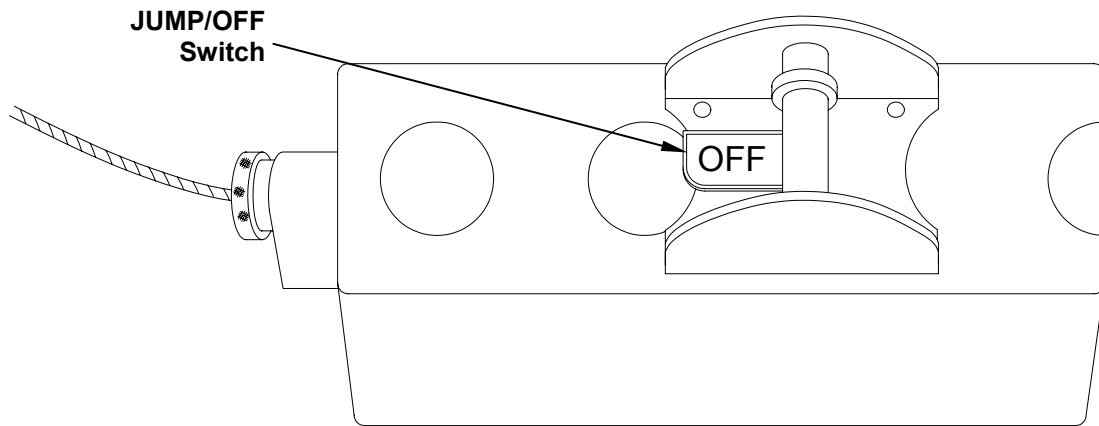

- b. Verify that the ball of the power cable is correctly engaged with the piston rod.

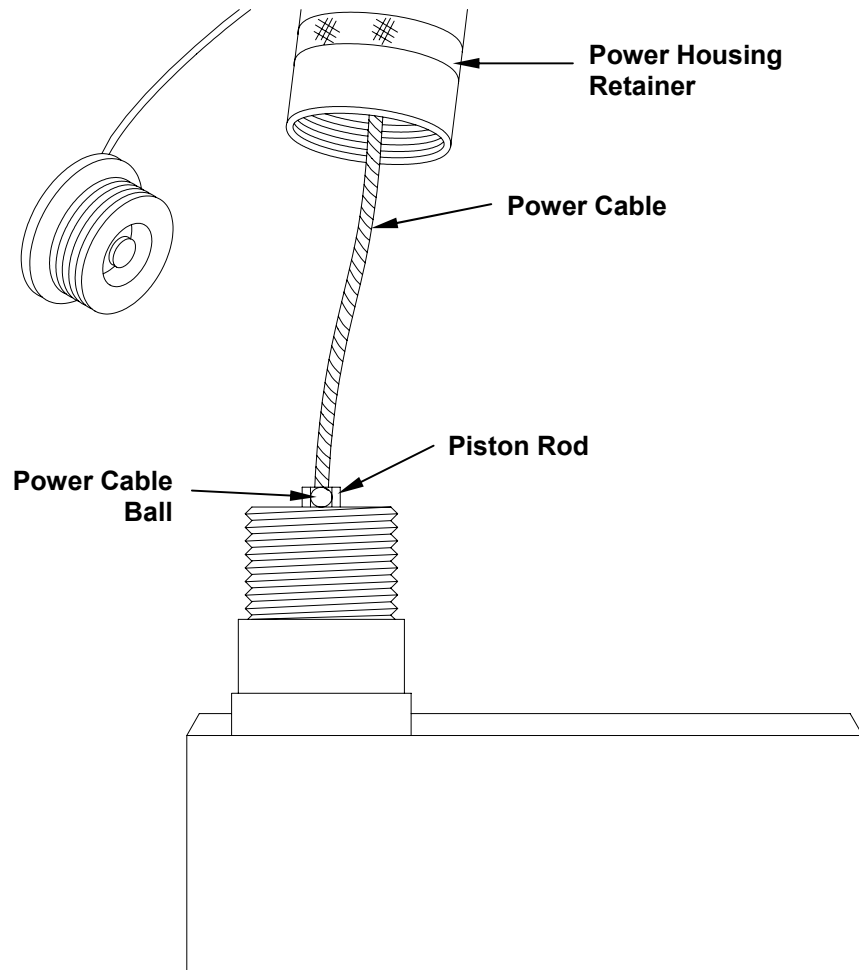



- c. Attach power-housing retainer to the AR2 finger tight. Verify that the ball of the power cable is correctly engaged with the piston rod by looking through transparent cable seal retainer.
  - d. Ensure that the cable seal retainer is present (located just above the power housing retainer).
  - e. Install the AR2 in the ripcord release pocket and close flap.
2. For units utilizing the Automatic Ripcord Release (FF-2), install as follows:
    - a. Align rectangular key on end of power cable housing and insert in corresponding slot in base plate.

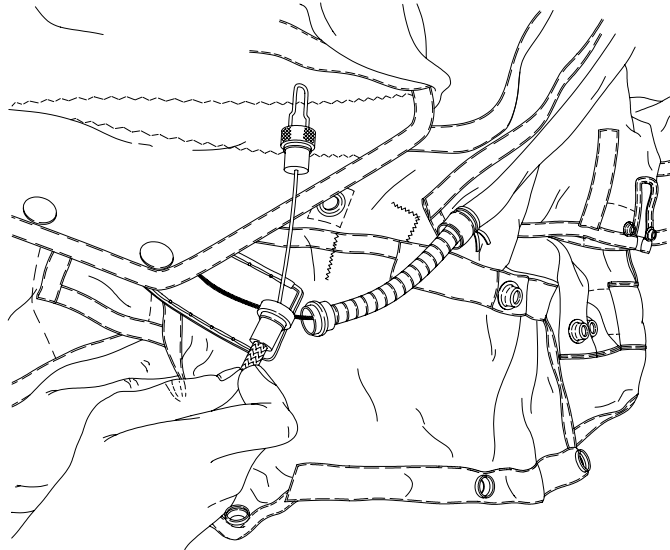

- b. Turn housing 90 degrees counterclockwise and lock in place.

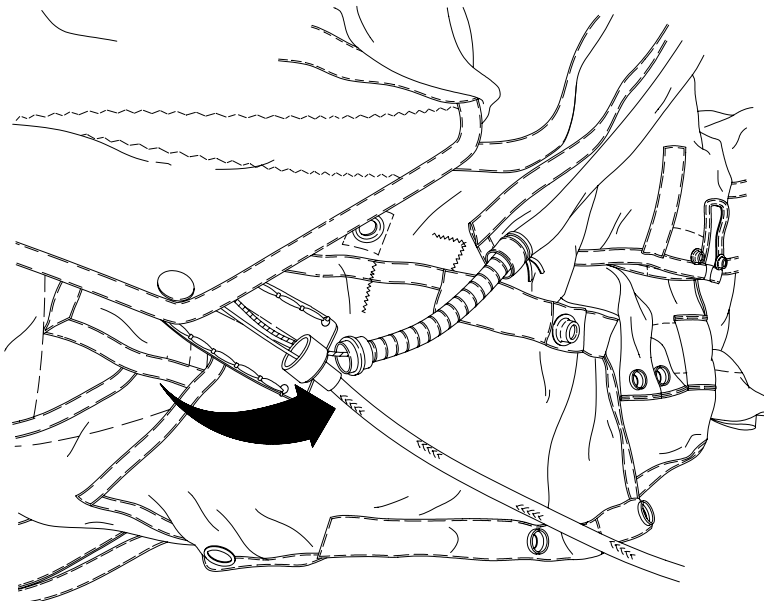

- c. Insert ripcord grip into ripcord release pocket.

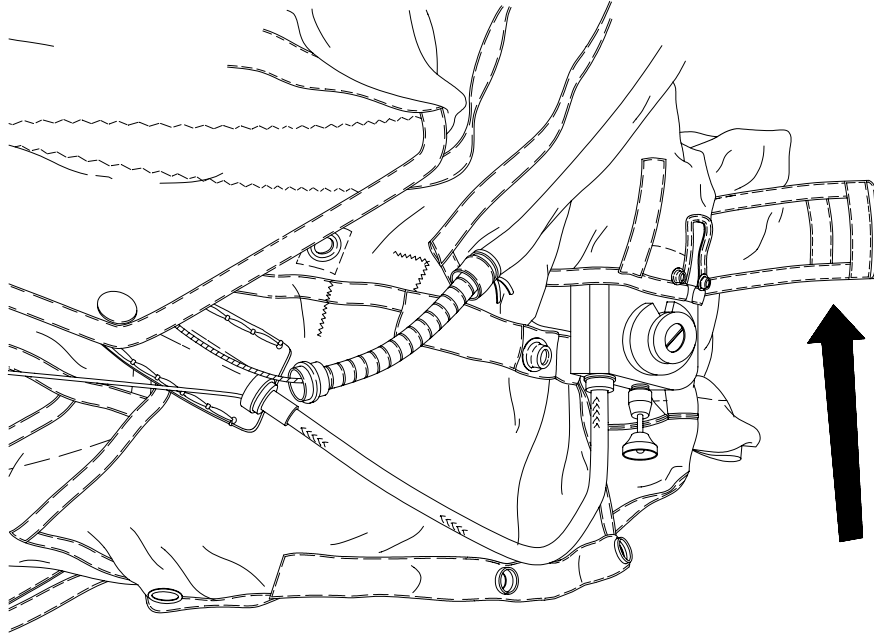

- d. Mate snap fasteners on securing straps to fasteners on pocket.

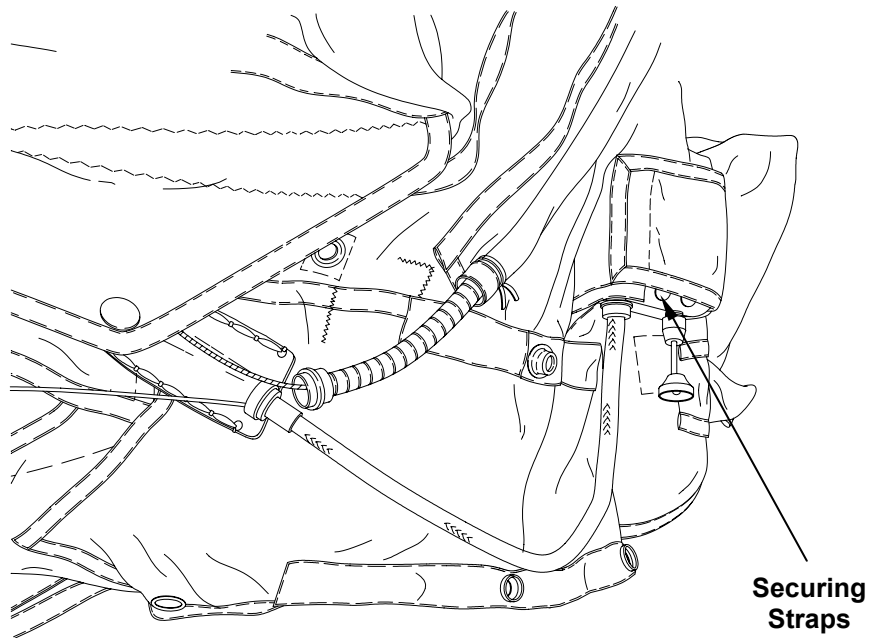

- e. Unscrew the knurled locking nut on the power cable.

- f. Place withdrawal hook around ripcord locking pin.
- g. Place withdrawal hook in withdrawal hook retainer.
- h. Tighten knurled locking nut finger tight.

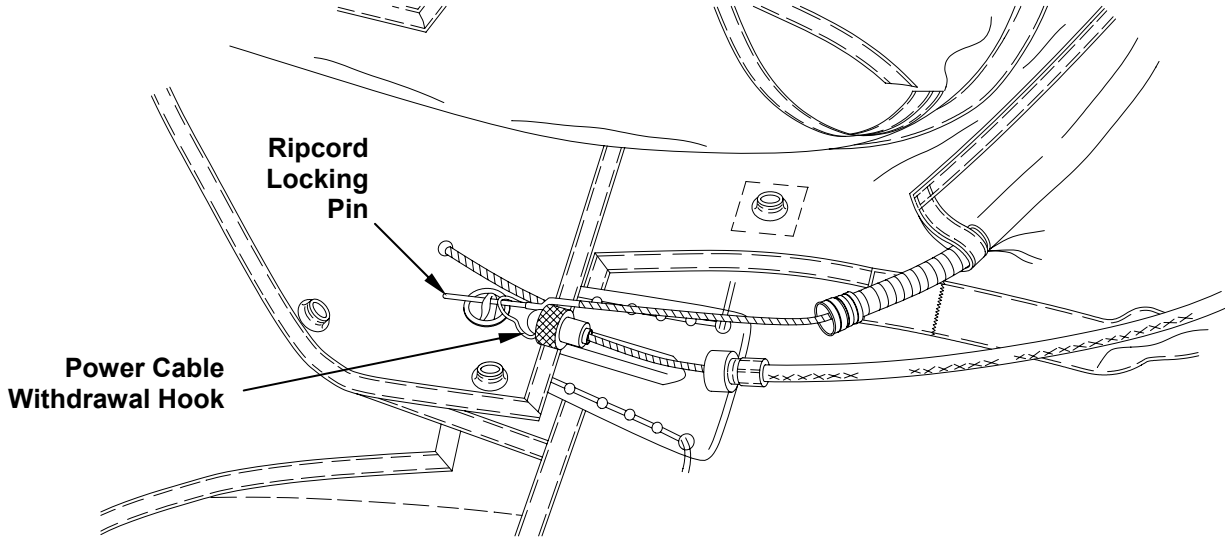

- i. Rigger check number 6.
- j. Close ripcord pin protective flap, cable housing protective flap, and riser protective covers.

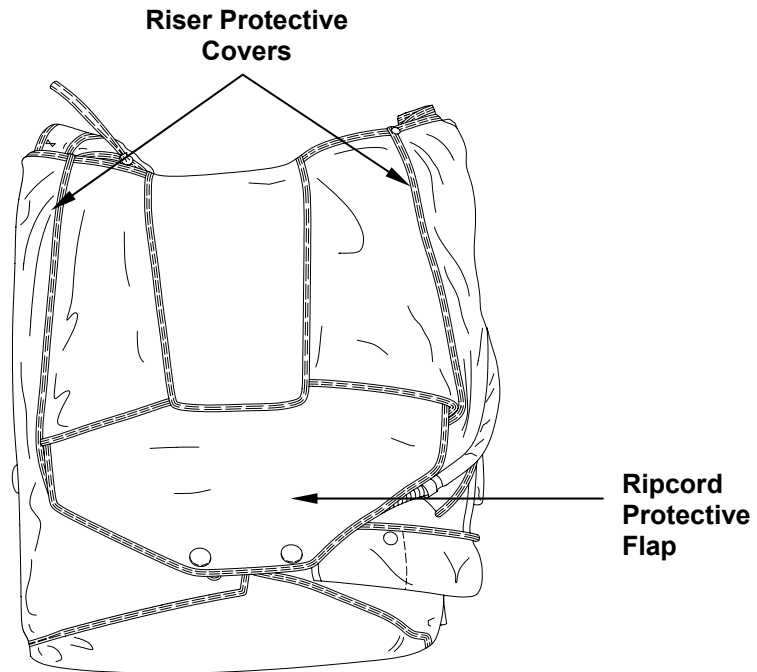

**END OF WORK PACKAGE**



---

**UNIT MAINTENANCE**  
**MC-4 RAM AIR FREE-FALL PERSONNEL PARACHUTE SYSTEM**  
**GENERAL REPAIR PROCEDURES**

---

**THIS TASK COVERS:**

- Basting and Temporary Tacking
  - Stitching and Restitching
  - Darning
  - Zig-Zag Sewing
  - Patching
- 

**INITIAL SETUP:****Equipment Condition**

Unpacked. Canopy with defects recorded. Clean.

**Personnel Required**

92R(10) Parachute Rigger

**Tools**

Specified in paragraph applicable to the item being repaired.

**Materials/ Parts**

Specified in paragraph applicable to the item being repaired.

---

NOTE

Sewing requirements will vary according to the type of item being repaired and the type of repair being made. The type of sewing machine, type of thread, the stitch range, and the stitch pattern (if applicable) required to accomplish a sewing procedure will be specified in the paragraph applicable to the item being repaired. Immediately after the accomplishment of a machine sewing procedure, trim thread ends to a point as close as possible to the material that has been sewn.

NOTE

Repair and replacement of parachute components is performed in accordance with the repair instruction in this section and in specific paragraphs applicable to the item being repaired.

**BASTING AND TEMPORARY TACKING**

Basting and temporary tacking are hand-sewing methods used to temporarily hold layers of cloth fabric together while a repair is being performed. The following is a list of procedures that apply to basting and temporary tacking actions:

1. Basting and temporary tacking should be made using thread that is of a contrasting color to the material being worked.
2. Basting and temporary tacking will be performed using a single strand of size A, nylon thread, or ticket No. 24/4 cotton thread.
3. When basting, do not tie knots at any point in the thread length. Also, the sewing should be made with two stitches per inch.
4. Immediately upon completion of a repair, remove previously made basting or temporary tacking.

**STITCHING AND RESTITCHING**

Perform stitching and re-stitching as follows, refer to Tables 1 and 2.

1. Parachute canopy assemblies. The stitching and re-stitching made on parachute canopies should be accomplished with thread that is contrasting in color to the fabric being re-stitched. If contrasting color thread is not available, thread of matching color may be used, providing all other specifications are met. Straight stitching and re-stitching on parachute canopy assemblies should be locked by at least 2-inches at each end of a stitch row, when possible. Zig-Zag stitching does not require locking; however, zig-zag re-stitching should extend at least ¼-inch into undamaged stitching at each end, when possible. When re-stitching parachute canopy assemblies, stitch directly over the original stitching and follow the original stitch pattern as closely as possible.

**Table 1. Sewing Machine Code Symbols**

CODE SYMBOL	SEWING MACHINE
LD	SEWING MACHINE, INDUSTRIAL: General Sewing; 301 Stitch; Light-Duty; NSN 350-01-177-8590.
MD ZZ	SEWING MACHINE, INDUSTRIAL: Zig-Zag; 308 Stitch; Medium-Duty; NSN 3530-01-181-1421.
LD ZZ	SEWING MACHINE, INDUSTRIAL: Zig-Zag; 308 Stitch; Light-Duty; NSN 3530-01-181-1420.
HD	SEWING MACHINE, INDUSTRIAL: General Sewing; 301 Stitch; Heavy-Duty; NSN 3530-01-177-8588.
MD	SEWING MACHINE, INDUSTRIAL: General Sewing; 301 Stitch; Medium-Duty; NSN 3530-01-177-8591.
DN	SEWING MACHINE, INDUSTRIAL: Darning; Lock Stitch; NSN 3530-01-177-8589.
LHD	SEWING MACHINE, INDUSTRIAL: 301 Stitch; Light-Heavy Duty; NSN 3530-01-186-3079.
ND	SEWING MACHINE, INDUSTRIAL: 301 Stitch; Double-Needle; NSN 3530-01-182-2873.
BT	SEWING MACHINE, AUTOMATIC: Box-X; (Local purchase, Herbert Jaffe/JF PN HJ1615X1X56, Model Number 3334)
BT	SEWING MACHINE, INDUSTRIAL: Bartack, 42 stitch (Local purchase, Recommended PN HJ1466-1X42)

**Table 2. Stitching and Re-stitching Specifications**

COMPONENT	RECOMMENDED SEWING MACHINE (Code Symbol)	STITCHES PER INCH	THREAD SIZE
Harness/Container			
Panels/Closing Flaps	LD, DN	7 to 11	E
Binding Tape, ¾-in.	LD, MD, ZZ, BT	7 to 11/42	E
Tape, Hook and Pile	LD, MD, BT	7 to 11/42	E
Pocket, ARR (FF-2)	LD, ZZ	7 to 11	E
Pocket, ARR (AR2)	LD, MD	7 to 11	E

■ **Table 2. Stitching and Re-stitching Specifications -continued**

COMPONENT	RECOMMENDED SEWING MACHINE (Code Symbol)	STITCHES PER INCH	THREAD SIZE
Binding Tape	LD	7 to 11	E
Flap, Main, Top Closing	LD	7 to 11	E
Binding Tape	LD	7 to 11	E
Ripcord Pocket, Main	LD, ZZ	7 to 11/42	E
Binding Tape	LD, ZZ	7 to 11	E
Ripcord Pocket, Reserve	LD, ZZ	7 to 11/42	E
Binding Tape	LD, ZZ	7 to 11	E
Protective Cover, ARR, Power Cable	MD	6 to 9	FF
Binding Tape	LD, BT	7 to 11/42	E
Tape, Hook, and Pile	LD, BT	7 to 11/42	E
Protective Cover, Reserve	MD	7 to 11	E
Binding Tape	LD	7 to 11	E
Tape, Hook, and Pile	LD	7 to 11	E
Pocket, Log Record	LD	7 to 11	E
Flap, Reserve, Top Closing	LD	7 to 11	E
Tape, Hook, and Pilot	LD	7 to 11	E
Carrying Handle	ZZ, BT	42	E
Loops, Weapon, Tie Down	ZZ	7 to 11	E
Pilot Chute Bridle Line	BT, LD	7 to 11/42	E
Deployment Bag, Main	LD, MD, DN	7 to 11	E
Canopy, Main	DN		A
Panel, Top/Bottom	LD, MD	7 to 11	E
Panel, Stabilizer	LD, MD, BT	7 to 11/42	E
Panel, Cotton Cloth	LD, MD	7 to 11	E
Ribs	LD, MD	7 to 11	E
Binding Tape	LD, MD	7 to 11	E
Slider Stop Reinforcement	LD, MD, BT	7 to 11/42	E
Line, Suspension	BT, ZZ	42	E
Line, Control	BT, ZZ	42	E
Tape, Reinforcement	LD, DN	7 to 11	E
Nylon Reinforcement, Pilot Chute	LD	7 to 11	E
Suspension Line Attaching Loop	DBL BT	Pre-set	E
Deployment Bag, Reserve	LD, MD, DN	7 to 11	E
Canopy, Reserve	DN		A
Conversion	LD	7 to 11	E
Panel, Top/Bottom	LD, MD	7 to 11	E
Panel, Stabilizer	LD, MD, BT	7 to 11/42	E

■ **Table 2. Stitching and Restitching Specifications - continued**

COMPONENT	RECOMMENDED SEWING MACHINE (Code Symbol)	STITCHES PER INCH	THREAD SIZE
Panel, Cotton Cloth	LD, MD	7 to 11	E
Ribs	LD, MD	7 to 11	E
Binding Tape	LD, MD	7 to 11	E
Slider Stop Reinforcement	LD, MD, BT	7 to 11/42	E
Line, Suspension	BT, ZZ	42	E
Line, Control	BT, ZZ	42	E
Panel, Top/Bottom	LD, MD	7 to 11	E
Crossports	D	7 to 11	E
Slider	LD, MD	7 to 11	E
Binding Tape	LD, MD	7 to 11	E
Cloth, Nylon, Type I	DN, LD	7 to 11	A/E
Suspension Line Attaching Loop	DBL BT	Pre-set	E
Risers (re-stitch as req'd)	LD, ZZ, BT	7 to 11/42	E
Keeper, Guide Ring	BT, ZZ	42	E
Tape, Trim Tab	LD, BT	7 to 11/42	E
Channel, Release Cable	LD, MD	7 to 11	E
Keeper, Toggle	LD, BT	7 to 11/42	E
Cover, Control Line	LD, MD	7 to 11	E
Tape, Hook and Pile	LD, MD	7 to 11	E

2. Other parachute items. Stitching and re-stitching on other parachute items constructed from cloth, canvas, and webbing should be accomplished with thread that matches the color of the original stitching, when possible. All straight stitching should be locked by backstitching at least ½-inch. Re-stitching should be locked by overstitching each end of the stitch formation by ½-inch. Zig-zag stitching does not require locking; however, zig-zag re-stitching should extend at least ¼-inch into undamaged stitching at each end, when possible. Re-stitching should be made directly over the original stitching; follow the original stitch pattern as closely as possible.

### DARNING

(Refer to Tables 1 and 2). Darning is a sewing procedure used to repair limited size holes, rips, and tears. A darning repair may be made either by hand or by sewing machine, depending upon the method preferred and the availability of equipment. However, a darning machine should be used to darn small holes and tears where fabric is missing. A darning repair will be preformed using the following procedures, as appropriate:

1. Machine darning. Proceed as follows:
  - a. Using an authorized marking aid of contrasting color, mark a square around the damaged area and ensure the marking is at least ¼-inch back from each edge of the damaged area.
  - b. Darn the damaged area by sewing the material in a back and forth manner, using size A or E nylon thread.



- c. Turn material and stitch back and forth across stitching made in step b., above, until hole or tear is completely darned.

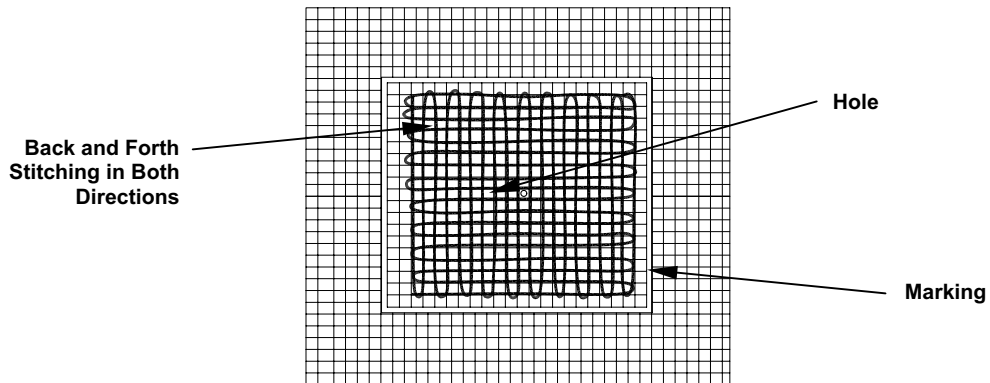

- d. If applicable, restencil informational data or identification marks using the criteria in WP 0017 00.

2. Hand darning. When repair of a hole or tear is made by hand darning, the darn should match the original weave of the damaged material as closely as possible. Hand darning is performed as follows:

- a. Using an authorized marking aid of contrasting color, mark a square around the damaged area and ensure that the marking is at least ¼-inch back from each edge of the damaged area.
- b. Using darning needle and a length of size A or E nylon thread, begin darning at one corner of marked area. Working parallel with the marking, pass needle and thread back and forth through material until opposite diagonal corner of marked area is reached as shown in A below.

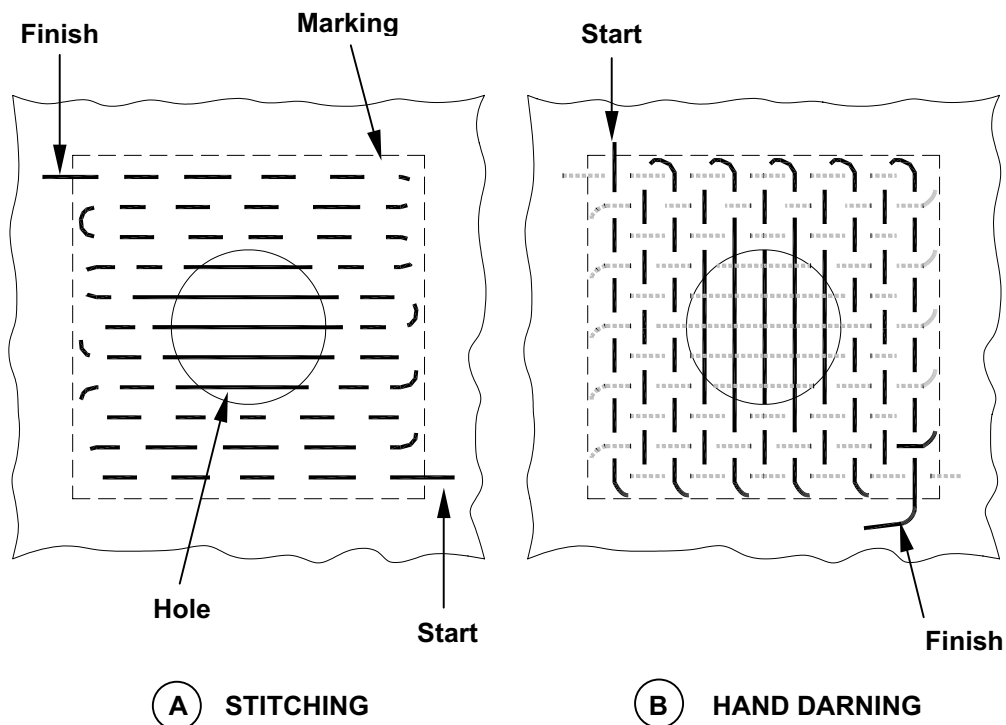

- c. Turn material and weave needle and thread back and forth across stitching made in step b., above, until hole is completely darned as shown in step b., above.
  - d. If applicable, restencil informational data or identification marks as outlined in WP 0017 00.
3. Zig-zag Sewing. (Refer to tables 1 and 2) Components of the MC-4, except parachute canopy, that have sustained cut or tear damage may be repaired by zig-zag sewing provided the applicable damaged area does not have any material missing and the cut or tear is straight or L-shaped. Should the damaged area be irregular shaped or have material missing, the repair will be achieved by either darning or patching, as required. A zig-zag sewing repair is accomplished using a zig-zag sewing machine as follows:
- a. Set sewing machine to maximum stitch width.
  - b. Beginning at a point  $\frac{1}{4}$ -inch beyond one end of cut or tear, stitch lengthwise along damaged area to a point  $\frac{1}{4}$ -inch beyond opposite end of cut or tear.

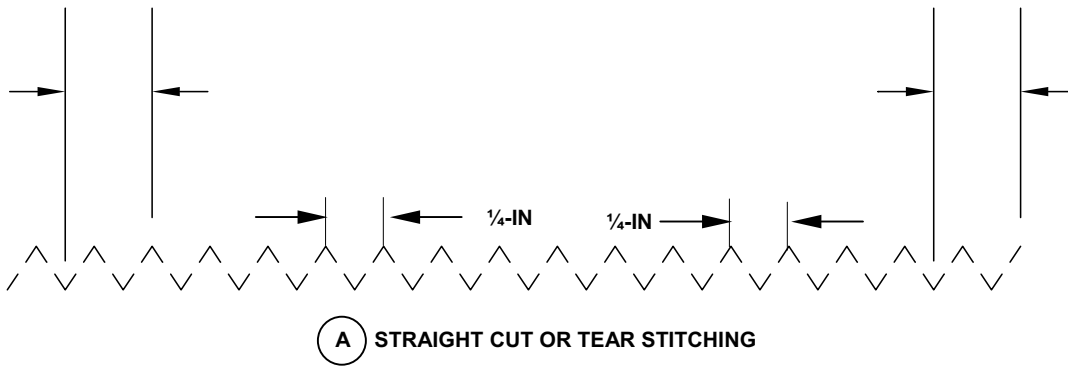

- c. The cited stitching procedure also applies to an L-shaped cut or tear.

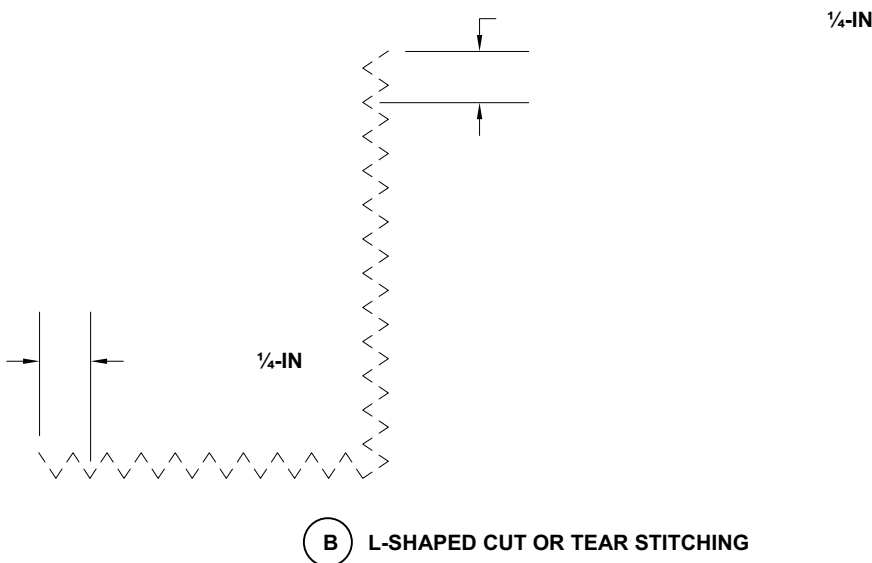

- d. If applicable, restencil information data or identification marks as prescribed in WP 0017 00.
4. Patching Procedures. Patching is a procedure used to repair holes that cannot be darned.
- a. Patching limitations for the parachute canopy and container. The following is a list of patching limitations for the MC-4 parachute canopy and container.
    - (1) A patch will not be applied to a damaged area that has been previously patched.
    - (2) There will be no more than two darns and three patches per section, rib, or stabilizer, not to exceed 50 percent. A canopy section is defined as an area between loaded ribs (on the left and right side rigger view) and from seam to seam from nose to tail.
    - (3) A rib and a stabilizer are each considered as one section. A finished basic patch shall not be closer than one-inch from a sewn seam. However, determination should be made as to the lowest economical method to be used (i.e., two or more patches verses one large patch or one large patch verses a section replacement).

NOTE

Patches must be cut with their edges parallel to the warp and weft of the fabric and are to be applied with the warp and weft threads parallel to those of the material under repair.

Canopy damage chart. A canopy damage chart is provided for local reproduction. The canopy damage chart is used to record canopy damage and repair action.

**TOP SKIN**

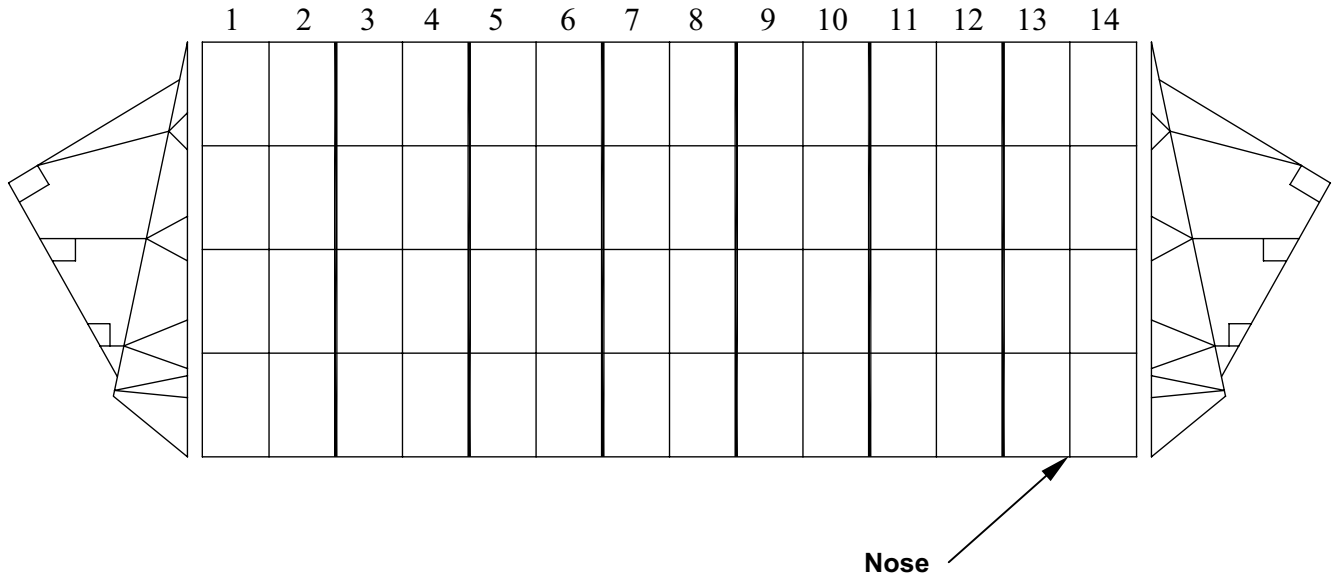

BOTTOM SKIN

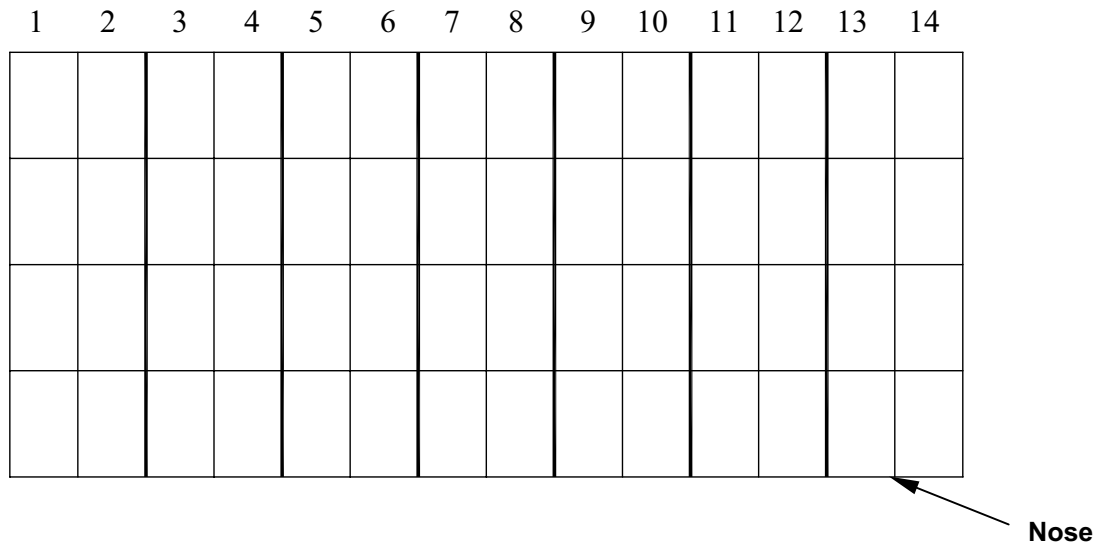

RIBS

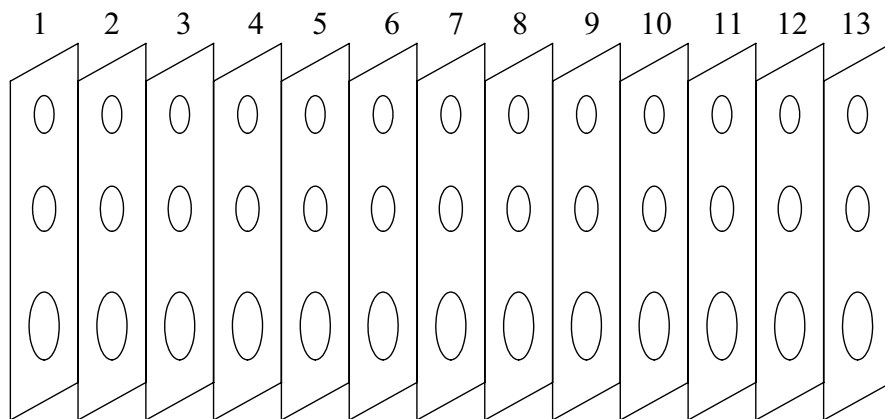

LEGEND			AMT	HRS	INSPECTION DATA	REPAIR DATA	
D	Darn	.8 X			<b>TYPE PARACHUTE</b>	<b>CANOPY REPAIR</b>	
RS	Resew	.8 X			MC-4	<b>NAME</b>	<b>DATE</b>
BR	Burn	.4 X			<b>SERIAL #</b>		
SRT	Splice Reinforcement Tape	.4 X					
RV	Replace Velcro	.4 X			DOM		
RE	Restencil	.4 X				<b>LINE REPAIR</b>	
RR	Replace Riser	.5 X			PIS	<b>NAME</b>	<b>DATE</b>
RSL	Replace Slider	.5 X					
SP	Sewn Patch	.8 X			WOD		
RLS	Replace Line Single	.8 X					
RCL	Replace Control Lines	1.0 X			<b>DATE INSPECTED</b>	<b>FINAL INSPECTION</b>	
SLS	Sew Line Set	1.5 X				<b>NAME</b>	<b>DATE</b>
RSB	Replace Stabilizer	2.0 X			<b>INSPECTED BY</b>		
RRH	Replace Rib Half	3.0 X					
RPS	Replace Panel Single	4.0 X			<b>REPAIR HRS</b>		
LS	Replace Line Set	3.5 X					
RPD	Replace Panel Double	7.0 X			<b>INSPECTION HRS</b>		
RRC	Replace Rib Complete	5.0 X			3.00		
RPM	Replace Panel Multi	X			<b>TOTAL HRS</b>		

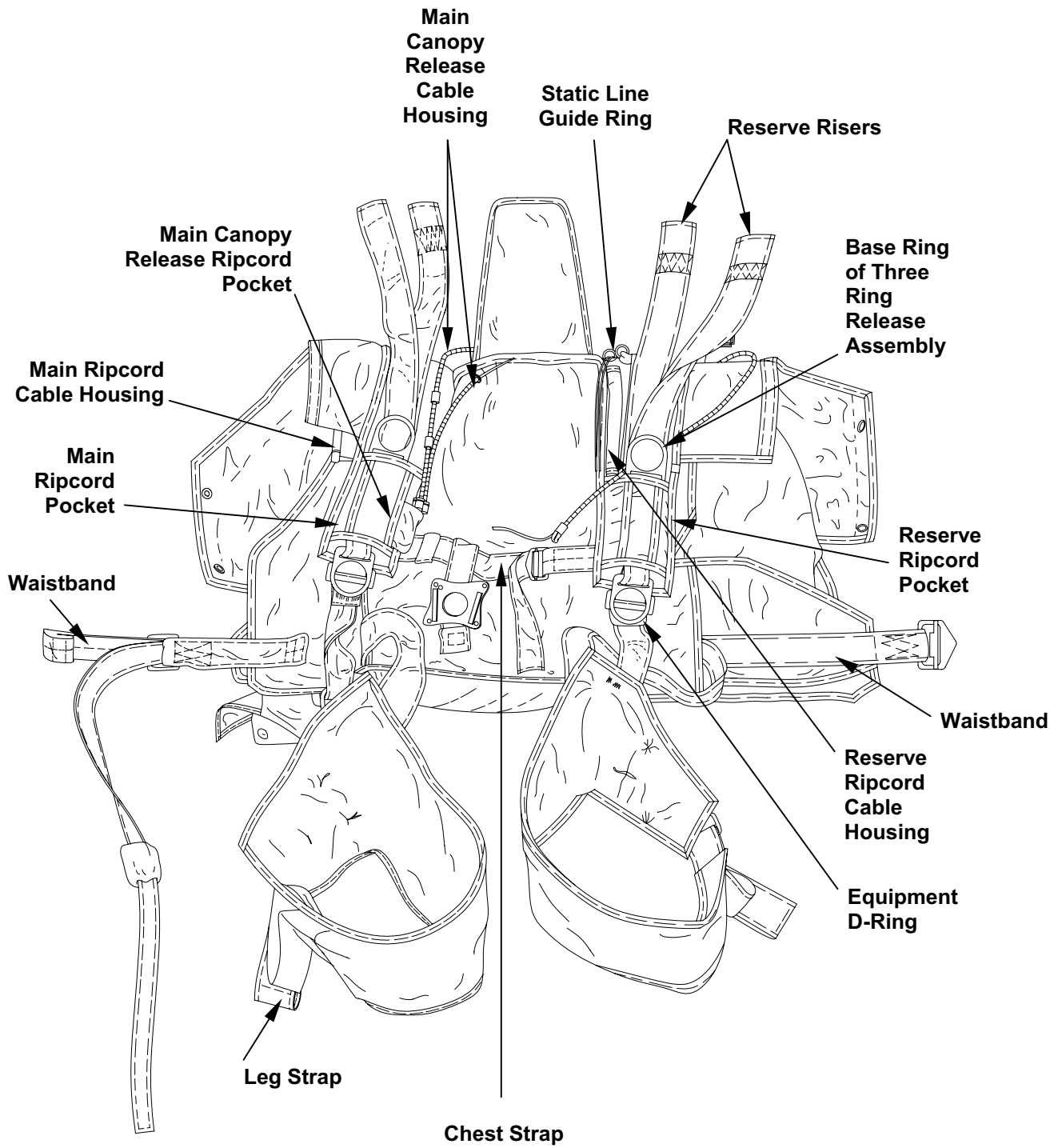

SYM	MC-4 REPAIRS	TIME ALLOW	AMT	HRS	SYSTEM NUMBER
RP	Replace FF-2/AR2 Pocket	.5			INSPECTED BY
SP	Sew Patch On Container	1.0			
RR	Replace Ripcord Housing Cover	3.5			REPAIR HOURS
RC	Replace Chest Strap	2.0			INSPECTION TIME
RB	Replace Waistband	4.0			
RE	Replace Elastic Strap	.4			TOTAL REPAIR HOURS
RSL	Replace Pack Stiffener (LG)	1.0			
RSS	Replace Pack Stiffener (SM)	.5			DATE INSPECTED
RSR	Replace Pack Stiffener (RES)	3.0			
RG	Replace Grommet Only	.4			REPAIRS COMPLETED BY
RV	Replace Velcro-Reserve Flap	.5			
RT	Re-tack	.4			
RW	Replace 3-IN. Wide Webbing	.5			DATE COMPLETED
II	Initial Inspection	.5			
FI	Final Inspection	.5			

5. Making a basic patch. A basic patch is used to repair damaged cloth when the finished patch is no closer than 1-inch from a stitched seam or stitched tape. Should a damaged area be closer than 1-inch to the cited areas, a miscellaneous patch will be made as detailed in paragraph 6, below. The basic patch is applied by sewing. The patch is applied to the inside of the canopy. The deployment bag is patched on the outside. The basic patch is shown below. Apply a basic patch as follows:

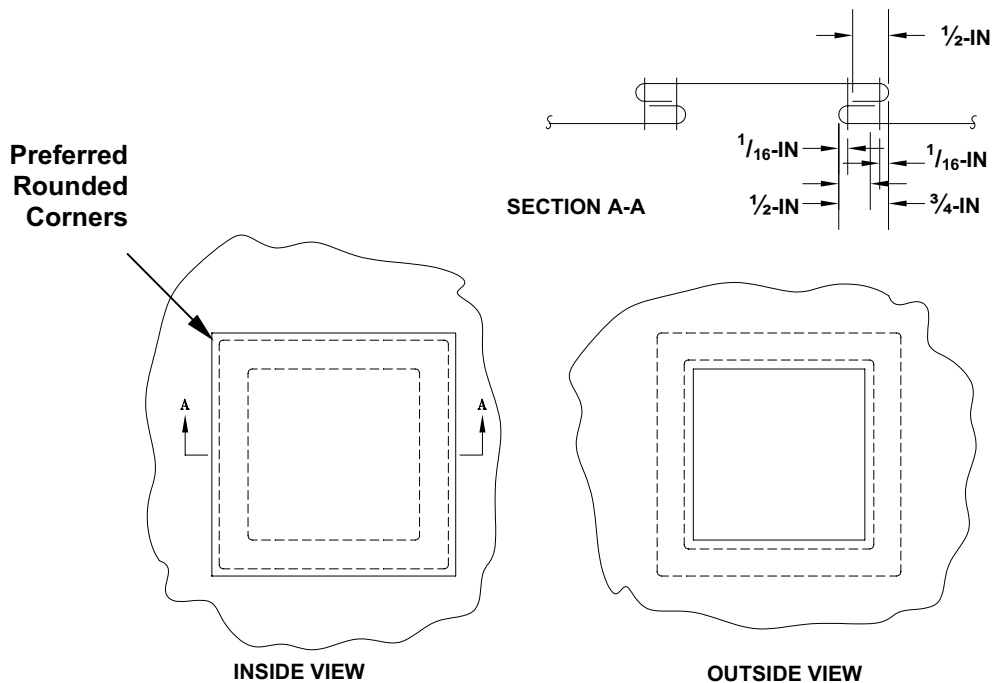

NOTE

A basic patch applied to the parachute canopy will be square or rectangular in shape. **ADHESIVE NYLON PARACHUTE MENDING CLOTH WILL NOT BE USED.** Ensure proper thread tension is used to prevent distortion of the canopy.

- a. Place repairable item on repair table, smooth the fabric around the damaged area, and secure item to table with push-up pins. Do not pin damaged area.
  - b. Using an authorized marking aid of contrasting color, mark a square or rectangle around area to be patched.
  - c. Cut damaged area fabric along the lines made in step b., above. Further cut the fabric diagonally at each corner to allow a ½-inch fold back in the raw edges.
  - d. Make a ½-inch fold back at each raw edge. Pin and baste each foldback to complete the prepared hole. Basting is performed using procedures on page 0015 00.
  - e. Using same type material as in original construction, mark and cut a patch 2 ½-inches wider and longer than the inside measurements of prepared hole.
  - f. Center patch material over prepared hole.
  - g. Make a ½-inch fold under on each edge of patch material and pin in position. Baste patch to prepared area. Basting is performed using procedures on page 0015 00.
  - h. Remove pushpins securing canopy to repair table and secure patch by stitching, using the applicable details in the illustration above and page 0015 00. Make the first row of stitching completely around patch. It is not necessary for the stitch pattern to exactly follow the angles of the patch. It is preferred to round the corners of the patch, to stitch at a 45-degree angle, rather than a 90-degree angle. For corners less than or greater than 90-degrees, adjust accordingly.
  - i. Turn canopy over and make second row of stitching, ensuring that locking stitches are on opposite sides of patch. Stitching is performed in accordance with page 0015 00.
  - j. If applicable, restencil informational data according to procedures in WP 0017 00.
6. Applying miscellaneous canopy patch. A miscellaneous canopy patch, which may be irregularly shaped, is used to repair damaged canopy material when the location of the damaged area requires the patch to extend into or over a seam or a reinforced seam. Ascertain the type of patch required for the canopy using the details in the illustrations on the following page. A canopy section that cannot be patched with a basic patch as outlined in paragraph 5., above, is patched with a miscellaneous patch. Apply a miscellaneous patch to a section as follows:



INSIDE VIEW

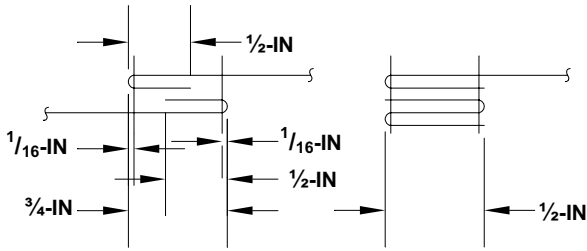
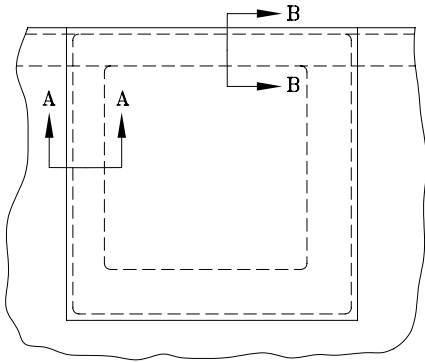

SECTION A-A

SECTION B-B

INSIDE VIEW

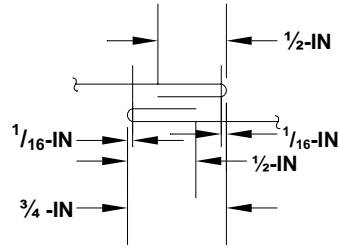
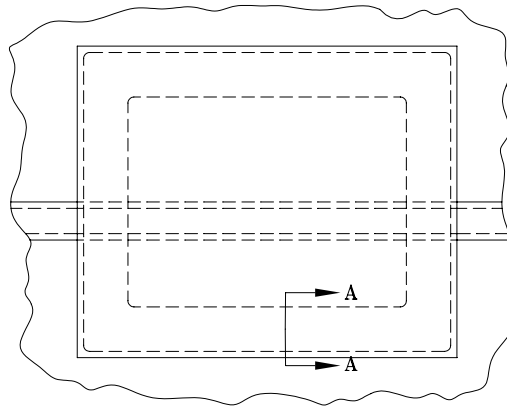

SECTION A-A

A. OUTSIDE VIEW

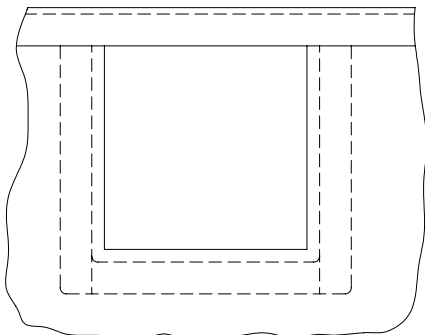

B. OUTSIDE VIEW

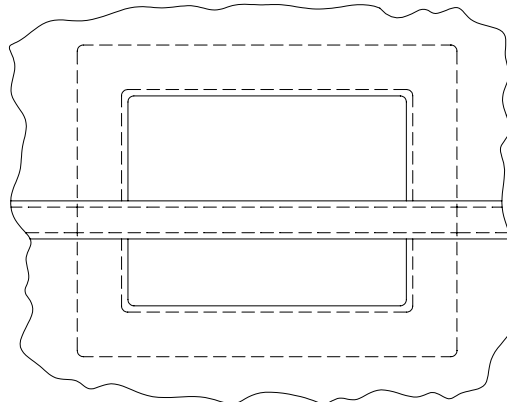

**NOTE:** FOR TWO OUTMOST RIBS, THE PATCH WILL BE APPLIED OVER THE REINFORCING TAPE.

A. RECTANGULAR PATCH AT REINFORCING TAPE OF LEADING EDGE (UPPER AND LOWER) FOR DAMAGE NOT CLOSER THAN 2-INCHES TO RIB SEAMS.

**NOTE:** FOR AN OUTSIDE RIB OVER A REINFORCING TAPE,

1. REMOVE STITCHING FROM REINFORCING TAPE.
2. APPLY A BASIC PATCH.
3. RE-STITCH THE REINFORCING TAPE.

B. RECTANGULAR PATCH CROSSING A REINFORCING TAPE.

**NOTE**

Adhesive nylon parachute mending cloth will not be used in the construction or application of a miscellaneous canopy patch.

- a. Place canopy inside out on a repair table, smooth fabric around damaged area, and secure damaged section to table with pushup pins. Do not pin damaged area of section.
- b. As required, cut applicable stitching to remove or lay aside items that may interfere with patching process.
- c. Using an authorized marking aid of contrasting color, mark damaged area. Mark the  $\frac{1}{2}$ -inch from any adjacent seam or reinforced seam, except where the width of the foldback is limited by the width of the reinforced seam.
- d. Prepare damaged area hole by cutting along marks made in step c., above. Also make a diagonal cut at each corner of formed hole to permit a foldback of each raw edge.
- e. To complete hole preparation, make a  $\frac{1}{2}$ -inch foldback of each raw edge. Pin and baste each edge foldback using procedures detailed in WP 0015 00.
- f. Using same type material as in original canopy construction, mark and cut a patch 2  $\frac{1}{2}$ -inches wider and longer than inside measurements of prepared hole.
- g. Center patch material over prepared hole.
- h. Make a  $\frac{1}{2}$ -inch foldunder on each edge of patch material and pin patch material in position. Baste patch to prepared area. Basting is performed using procedures detailed in WP 0015 00.
- i. Remove pushpins securing canopy to repair table and secure patch by stitching according to the details in the illustrations above and below, using stitching specifics outlined in tables 1 and 2.

INSIDE VIEW

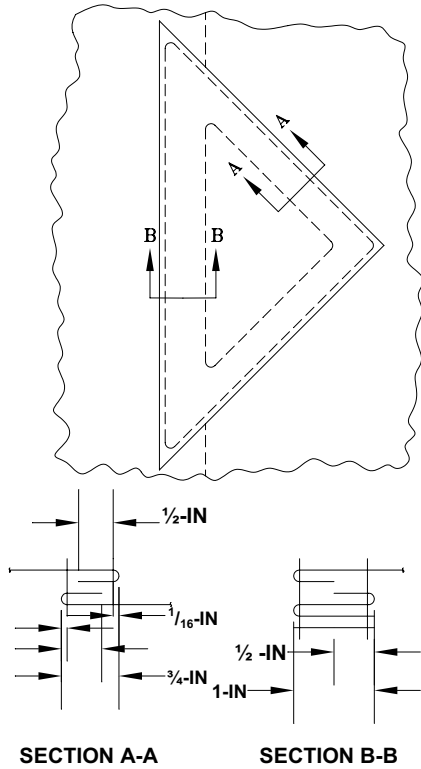

INSIDE VIEW

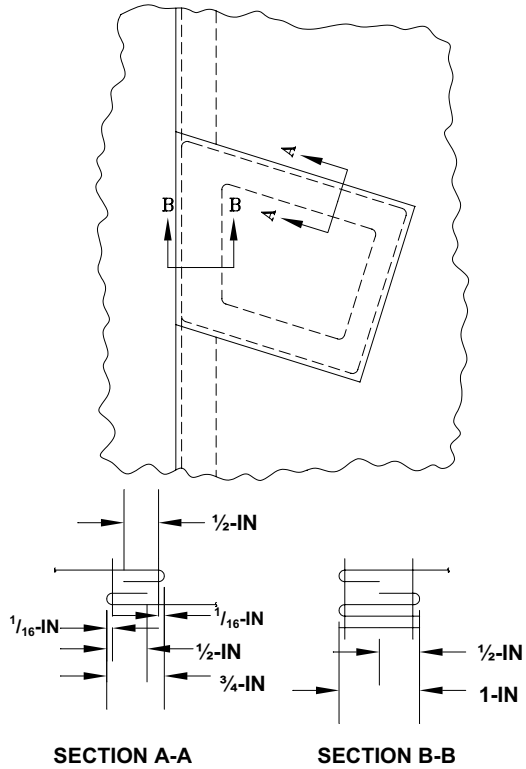

C. OUTSIDE VIEW

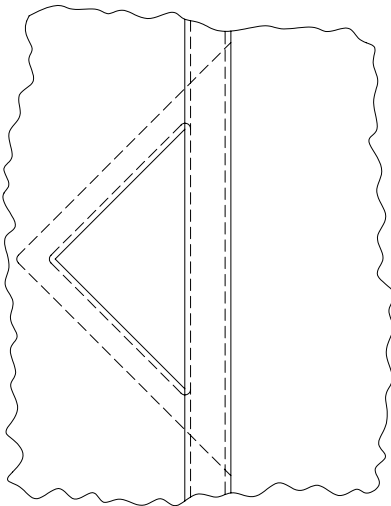

C. TRIANGULAR PATCH AT FRONT LEADING EDGE OF RIBS.

D. OUTSIDE VIEW

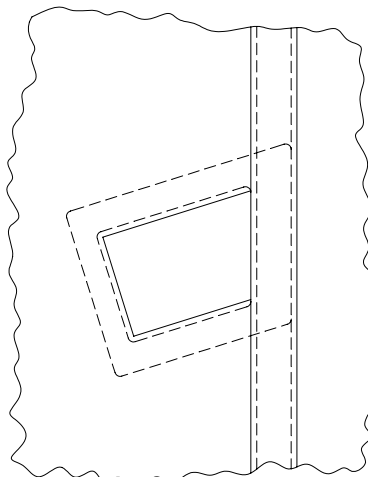

D. FOUR-SIDED PATCH AT FORWARD LEADING EDGE OF RIBS.

- j. Make the first row of stitching completely around the edges of the patch. Turn canopy right side out and make a second row of stitching, ensuring that locking stitches are on opposite sides of patch. Stitching is performed in accordance with WP 0015 00.
- k. Reposition canopy items removed or laid aside in step b., above, in the original location and secure each item to canopy by restitching according to original construction details and WP 0015 00.
- l. If applicable, restencil informational data according to procedures in WP 0017 00.

**END OF WORK PACKAGE**

---

**UNIT MAINTENANCE**  
**MC-4 RAM AIR FREE-FALL PERSONNEL PARACHUTE SYSTEM**  
**SEARING AND WAXING**

---

**THIS TASK COVERS:**

- Searing
  - Waxing
- 

**INITIAL SETUP:****Tools**

Knife, Hot, Metal (Item 24, WP 0063 00)  
Pot, Melting Electric (Item 34, WP 0063 00)

**Personnel Required**

92R (10) Parachute Rigger

**Materials/Parts**

Beeswax (Item 5, WP 0076 00)  
Wax, Paraffin (Item 46, WP 0076 00)

**Equipment Condition**

Unpacked.

---

---

**CAUTION**

---

Cotton tape, webbing, or cord will not be seared.

---

**NOTE**

---

Fabric materials such as cord, tape, and webbing that is cut for use in the maintenance of the MC-4 parachute will normally be heat-seared or dipped in a melted wax mixture, as applicable, to prevent the material from fraying or unraveling. However, in some instances the preparation of the material may not be necessary and will be specified accordingly.

**SEARING**

The cut ends of nylon tape, webbing, and cord lengths may be prepared by heat-searing, which is performed by pressing the raw end of the material against a hot metal surface (knife) until the nylon has melted sufficiently.

---

**CAUTION**

---

Avoid forming a sharp edge or lumped effect on the melted end.  
Sharp edges may cut other components

**WAXING**

Fraying or unraveling of cotton or nylon tape, webbing, and cord length ends may be prevented by dipping ½-inch of the raw end of the material into a thoroughly melted mixture of half beeswax and half paraffin in an electric melting pot. The wax temperature should be substantial enough to ensure the wax completely penetrates the material rather than just coating the exterior fabric.

**END OF WORK PACKAGE**



---

**UNIT MAINTENANCE**  
**MC-4 RAM AIR FREE-FALL PERSONNEL PARACHUTE SYSTEM**  
**MARKING AND RESTENCILING**

---

**THIS TASK COVERS:**

- Marking
  - Re-stenciling
- 

**INITIAL SETUP:****Tools**

Brush, Stenciling (Item 5, WP 0063 00)  
Machine, Stencil Cutting (Item 26, WP 0063 00)

**Materials/Parts**

Ink, Marking, Parachute (Item 25/26, WP 0076 00)  
Marker, Felt Tip, Permanent, Black (Item 28, WP 0076 00)  
Pen, Ball Point (Item 29, WP 0076 00)  
Stencil Board, Oiled (Item 31, WP 0076 00)

**Personnel Required**

92R (10) Parachute Rigger

**Equipment Condition**

Lay out on packing table or other suitable area.

---

**NOTE**

Stenciling should be used whenever possible. A ballpoint pen or permanent felt tip marker should be used only where stenciling is not possible, or when stenciling devices are not available. Any type ball point pen using black or blue ink may be used for marking on labels only.

Original stenciled data or marking that becomes faded, illegible, obliterated, or are removed as a result of performing a repair procedure will be remarked with a ballpoint pen, felt tip marker, or re-stenciled. All marking or re-stenciling will be done on or as near as possible to the original location and should conform to the original lettering type and size.

**MARKING**

Using marking devices such as ballpoint pen or permanent felt tip marker, mark on, or as near as possible to, original location and conform to original lettering type and size.

**RESTENCILING**

Proceed as follows:

1. Cut oiled stencil board to original lettering type and size of data to be re-stenciled.
2. Place cut stencil board over, or as near as possible to, original marking to be re-stenciled.
3. Place additional sheet or stencilboard beneath area to be re-stenciled to prevent marking ink from penetrating to other areas.
4. Hold stencilboard in place and, using stenciling brush filled with parachute marking ink, re-stencil original marking.

**END OF WORK PACKAGE**





---

**UNIT MAINTENANCE**  
**MC-4 RAM AIR FREE-FALL PERSONNEL PARACHUTE SYSTEM**  
**MAIN PILOT CHUTE BRIDLE LINE OR DEPLOYMENT BAG**

---

**THIS TASK COVERS:**

- Remove
- Install

**INITIAL SETUP:****Materials/Parts**

Bag, Deployment (Item 7, WP 0065 00)  
Bridle Assembly, Pilot Chute (Item 2, WP 0065 00)

**Personnel Required**

92R (10) Parachute Rigger

**Equipment Condition**

Lay out on packing table or other suitable area.

---

**REMOVE**

Remove main pilot chute bridle line or deployment bag as follows:

1. Loosen bridle line girth hitch enough so that pilot chute can be passed through loop in end of bridle line.

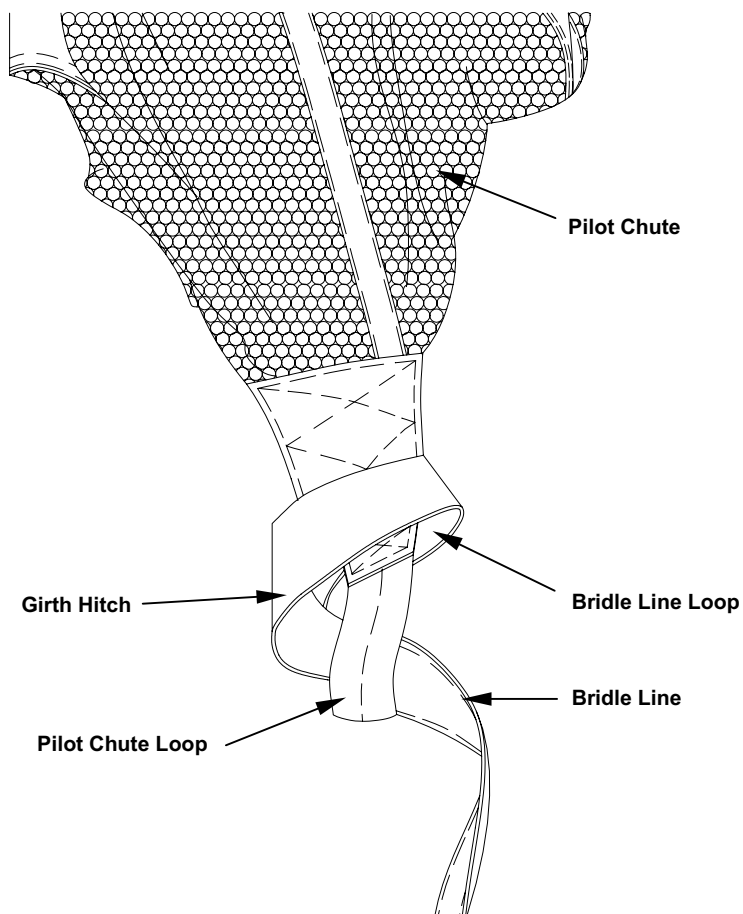

2. Remove bridle line from loop at bottom end of pilot chute.

- Loosen bridle line girth hitch at canopy attachment ring.

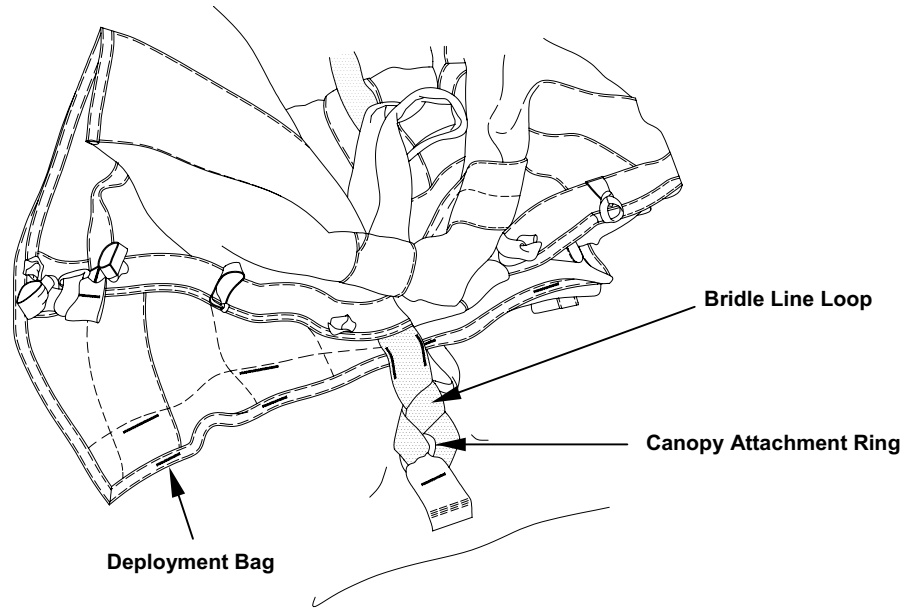

- Pass deployment bag and opposite end of bridle line through bridle line loop.
- Remove bridle line from canopy attachment ring and deployment bag.

**INSTALL**

Install main pilot chute bridle line or deployment bag as follows:

- Pass bridle line loop at ring end through deployment bag from outside to inside.

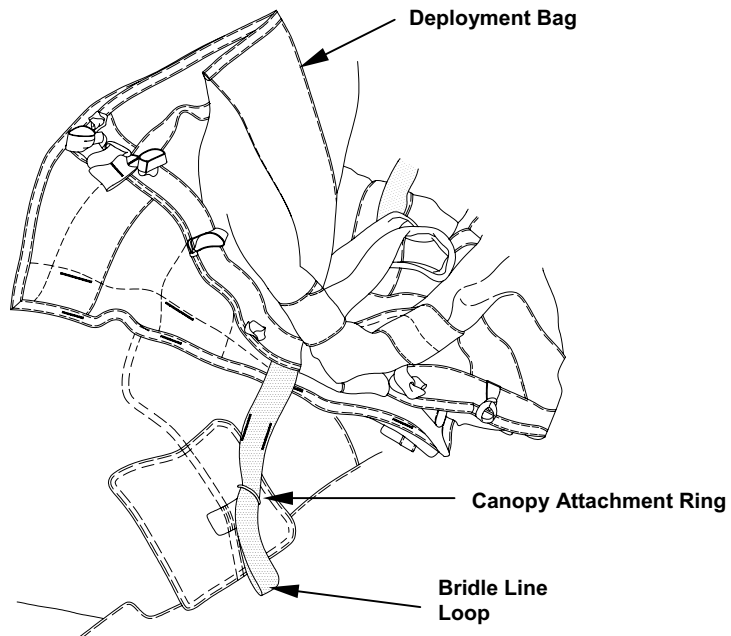

2. Pass bridle line loop at ring end completely through canopy attachment ring.
3. Pass opposite end of bridle line and deployment bag through bridle line loop and pull tight, forming a girth hitch.
4. Pass bridle line through loop at bottom end of pilot chute.

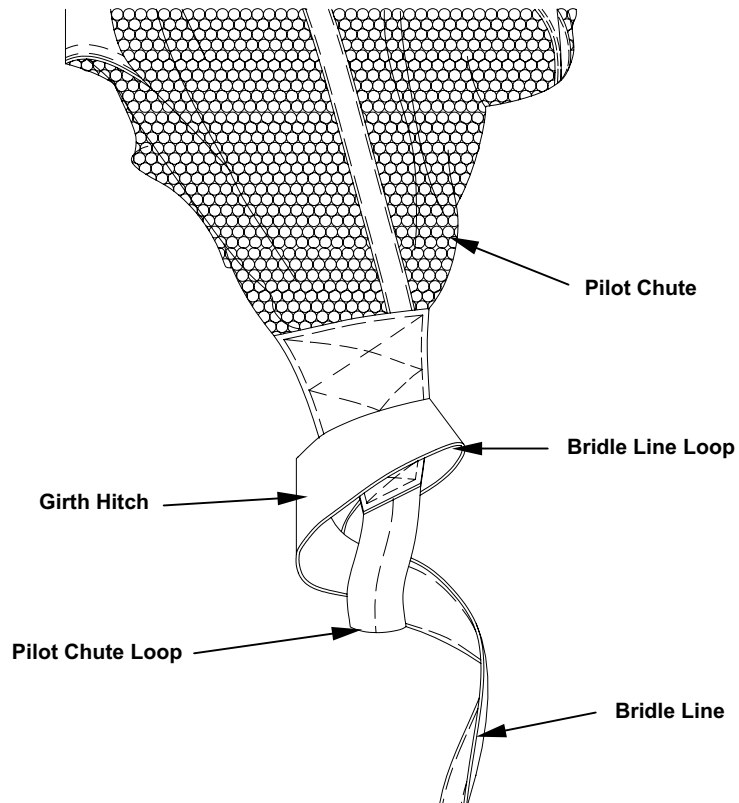

5. Pass pilot chute through loop at end of bridle line and pull tight, forming a girth hitch.

**END OF WORK PACKAGE**



---

**UNIT MAINTENANCE**  
**MC-4 RAM AIR FREE-FALL PERSONNEL PARACHUTE SYSTEM**  
**MAIN PILOT CHUTE**

---

**THIS TASK COVERS:**

- Repair
  - Replace
- 

**INITIAL SETUP:****Tools**

Needle, Basting (Item 28, WP 0063 00)

**Personnel Required**

92R (10) Parachute Rigger

**Materials/Parts**

Pilot Chute, Main (Item 1, WP 0065 00)

Thread, Nylon, Size A (Item 45, WP 0076 00)

**Equipment Condition**

Lay out on packing table or other suitable area.

---

**REPAIR**

Repair damaged pilot chute canopy material by hand darning holes no larger than ½-inch in diameter and limited to four (4) darns per material for a total of eight (8). Hand darn IAW WP 0015 00.

**REPLACE**

Replace main pilot chute as follows:

1. Loosen bridle line girth hitch enough so that pilot chute can be passed through loop in end of bridle line.

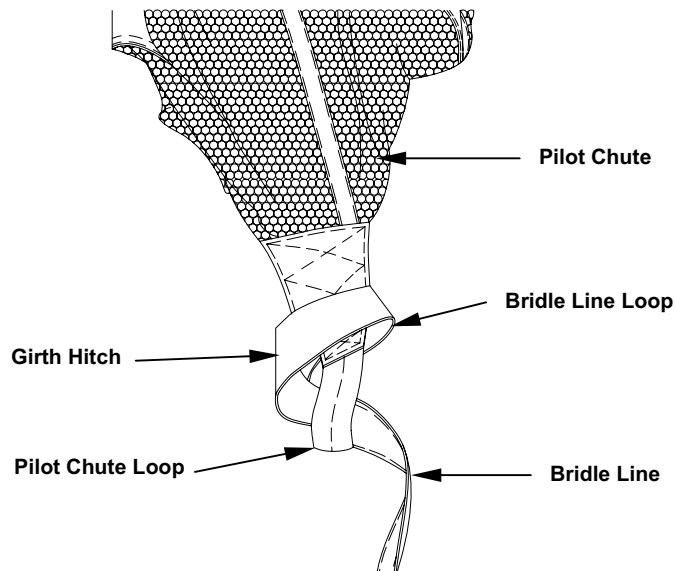

2. Remove bridle line from loop at bottom end of pilot chute.
3. Pass bridle line through loop at bottom end of replacement pilot chute.
4. Pass pilot chute through loop at end of bridle line and pull tight forming a girth hitch.

**END OF WORK PACKAGE**



---

**UNIT MAINTENANCE**  
**MC-4 RAM AIR FREE-FALL PERSONNEL PARACHUTE SYSTEM**  
**MAIN AND RESERVE PILOT CHUTE ATTACHMENT**

---

**THIS TASK COVERS:**

- Repair
  - Replace
- 

**INITIAL SETUP:****Tools**

Knife (Item 23, WP 0063 00)  
 Pliers, Large, Diagonal Cut (Item 32, WP 0063 00)  
 Sewing Machine, Automatic Box-X (Table 1, WP 0015 00)  
 Sewing Machine, Bartack (Table 1, WP 0015 00)  
 Sewing Machine, Double Needle (Table 1, WP 0015 00)  
 Sewing Machine, Light-Duty (Table 1, WP 0015 00)  
 Shears (Item 39, WP 0063 00)

**Personnel Required**

92R (10) Parachute Rigger

**Equipment Condition**

Layout on packing table or other suitable area.

**Material/Parts**

Tape, Nylon, 1-Inch Wide, Gray (Item 34, WP 0076 00)  
 Thread, Nylon, Size E (Item 43/44, WP 0076 00)  
 Style Force 9, 1.9-oz Ripstop Weave, 2-IN. Wide (Item 32, WP 0076 00)

---

**REPLACE PILOT CHUTE ATTACHING RING**

1. Carefully cut and remove damaged pilot parachute ring and strap.
2. Obtain a 9-inch length of 1-inch wide nylon tape from supply stock and fabricate a new strap IAW the original construction.
3. Using an automatic box-X sewing machine, and size E nylon thread, re-sew ring and strap to the canopy as close to the original position as possible ensuring it is sewn to the nylon tape on the rib.

**REPLACE PILOT CHUTE ATTACHING RING NYLON REINFORCEMENT**

1. Remove pilot chute ring as stated in "Replace Pilot Chute Attaching Ring", step 1., above.
2. Beginning at a point approximately 6-inches out from the edge of the nylon reinforcement, carefully cut and remove stitching that secures the rib to the top skin through the nylon reinforcement, and 6-inches beyond the nylon reinforcement (approximately 12-inches of stitching should be removed).
3. Carefully cut and remove stitching which secures the nylon reinforcement to the top skin.
4. Remove the nylon reinforcement.
5. Obtain from supply stock a 7-inch by 7-inch piece of Style-Force 9 fabric.
6. Install the nylon to the top skin using the old one as a guide and sew as close to the original position as possible.
7. Using a light-duty sewing machine and size E nylon thread, sew a double row of stitching.
8. Re-sew the rib previously removed in step 2., above, using original construction and stitch formation.
9. Re-sew the pilot parachute-attaching ring removed in step 1., above, using procedures in step 3. in the REPLACE PILOT CHUTE ATTACHING RING paragraph detailed above.

**NOTE**

When making repairs to the canopy material where the cotton material and the No. 8 grommet must be removed to expose the damaged area; it is not necessary to replace the cotton material and the No. 8 grommet after the canopy repairs have been completed.

**REPAIR COTTON REINFORCEMENT AROUND PILOT PARACHUTE ATTACHING RING**

1. Repairs to the cotton reinforcement are limited to re-stitching and darning only.
2. Holes that do not exceed  $\frac{3}{4}$ -inch can be darned.
3. Darns are permitted to penetrate the cotton material as well as the top skin.
4. Darns are not permitted in the nylon reinforcement material.
5. Darn IAW procedures listed in WP 0015 00.

**END OF WORK PACKAGE**



**UNIT MAINTENANCE**  
**MC-4 RAM AIR FREE-FALL PERSONNEL PARACHUTE SYSTEM**  
**MAIN DEPLOYMENT BAG**

**THIS TASK COVERS:**

- Repair

**INITIAL SETUP:**

**Tools**

Die Set, Spur Grommet No. 5 (Item 12, WP 0063 00)  
 Mallet, Rawhide (Item 27, WP 0063 00)  
 Pliers, Large, Diagonal Cut (Item 32, WP 0063 00)  
 Sewing Machine, Light-Duty (Table 1, WP 0015 00)  
 Shears (Item 39, WP 0063 00)

**Materials/Parts**

Cloth, Nylon, Type III, Class 3, Black (Item 10, WP 0076 00)  
 Grommet, Metallic, No. 5, Type III, Class 2 (Item 22, WP 0076 00)  
 Thread, Nylon, Size E (Item 43/44, WP 0076 00)

**Personnel Required**

92R (10) Parachute Rigger

**Equipment Condition**

Lay out on packing table or other suitable area.  
 Bridle line removed from deployment bag.

**REPAIR**

1. Restitching. Sew over loose or broken stitching on original stitch line with size E nylon thread. New stitching shall extend  $\frac{3}{4}$ -inch beyond affected area in both directions.

**NOTE**

For stitching, use stitch type 301, FED-STD-751, 7 to 11 stitches per inch.

2. Patching. Apply a basic or miscellaneous patch, as required, in accordance with WP 0015 00.
3. Bridle Grommet Replacement. Replace bridle grommet as follows:
  - a. Cut crimped edge of damaged grommet at three or four points.
  - b. Remove grommet and washer.
  - c. Cover hole in deployment bag with square patch of nylon cloth that is  $\frac{3}{8}$ -inch larger than grommet washer.

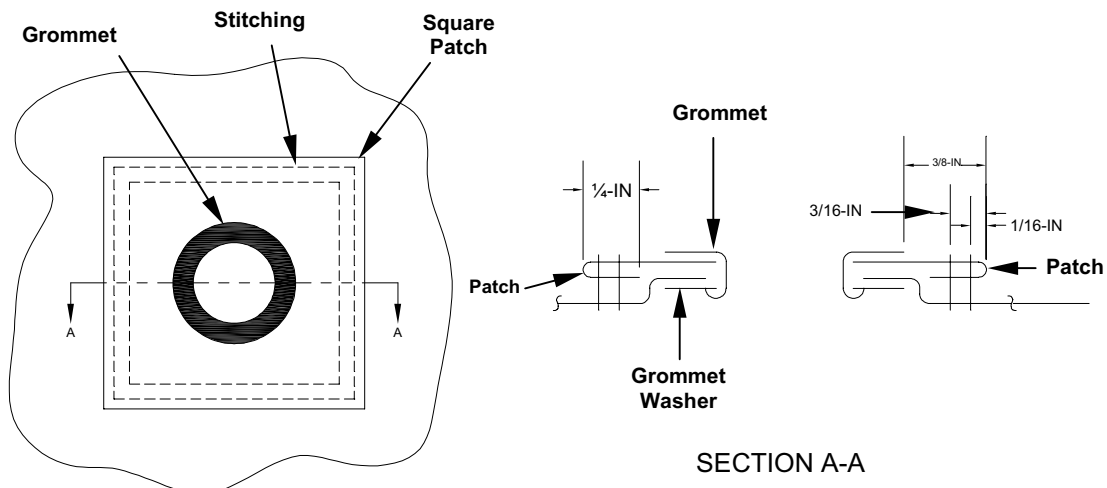

- d. Turn edges under  $\frac{1}{4}$ -inch and sew to deployment bag with size E nylon thread, 7 to 11 stitches per inch, type 301. Stitch patch on all four (4) sides with two (2) rows of stitching.
- e. Cut a  $\frac{5}{8}$ -inch diameter hole (Size 5 punch) in center of patch.
- f. Place grommet washer on inside of patch. Place grommet on outside of patch.
- g. Lock grommet and grommet washer in place with die set.

**END OF WORK PACKAGE**

---

**UNIT MAINTENANCE**  
**MC-4 RAM AIR FREE-FALL PERSONNEL PARACHUTE SYSTEM**  
**RESERVE PILOT CHUTE OR RESERVE DEPLOYMENT BAG AND BRIDLE LINE**

---

**THIS TASK COVERS:**

- Remove
  - Install
- 

**INITIAL SETUP:****Materials/Parts**

Deployment Bag and Bridle Assembly (Item 2, WP 0067 00)  
 Pilot Chute, Reserve (Item 1, WP 0067 00)

**Personnel Required**

92R (10) Parachute Rigger

**Equipment Condition**

Lay out on packing table or other suitable area.

---

**REMOVE**

Remove reserve pilot chute or deployment bag and bridle assembly as follows:

1. Loosen reserve deployment bag bridle line girth hitch enough so that the bridle line and deployment bag can be passed through loop in end of bridle line.

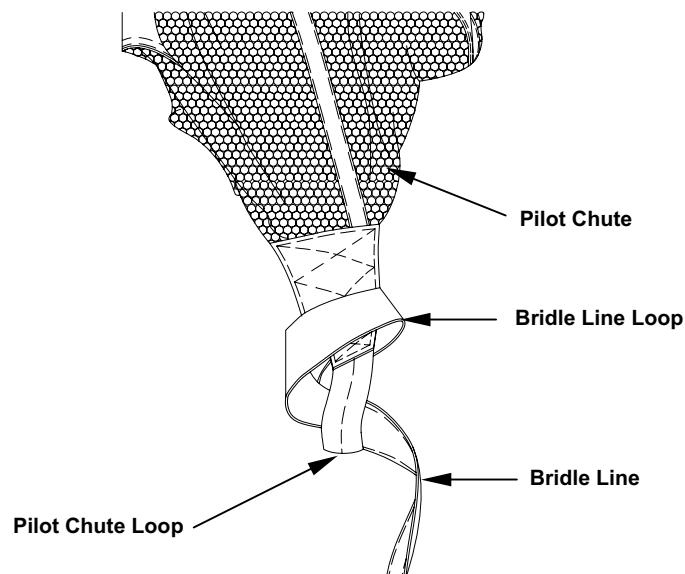

2. Remove reserve deployment bag bridle line at bottom end of pilot chute.

**INSTALL**

Install reserve pilot chute or deployment bag and bridle line as follows:

1. Pass the bridle line through loop at bottom end of pilot chute.
2. Pass deployment bag through loop at end of bridle line and pull tight, forming a girth hitch.

**END OF WORK PACKAGE**



---

**UNIT MAINTENANCE**  
**MC-4 RAM AIR FREE-FALL PERSONNEL PARACHUTE SYSTEM**  
**SAFETY STOW LOOP**

---

**THIS TASK COVERS:**

- Remove
  - Install
- 

**INITIAL SETUP:****Materials/Parts**

Loop, Safety Stow (Item 3, WP 0067 00)

**Personnel Required**

92R (10) Parachute Rigger

**Equipment Condition**Lay out on packing table or other suitable area.

---

**REMOVE**

Remove safety stow loop as follows:

1. Pull both ends of safety stow loop down through grommets on reserve deployment bag.

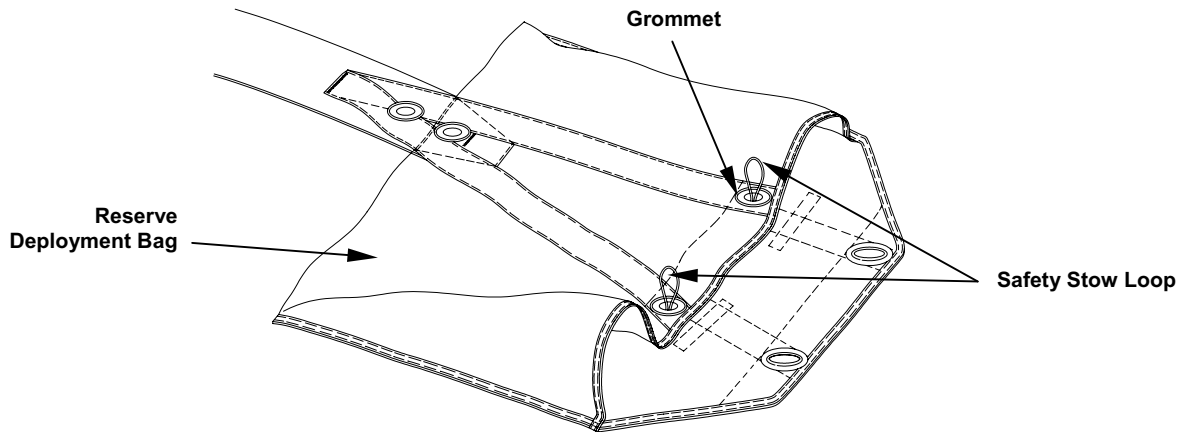

2. Pull safety stow loop completely through guide channel. Cut safety stow loop before discarding. This will prevent inadvertent re-use.

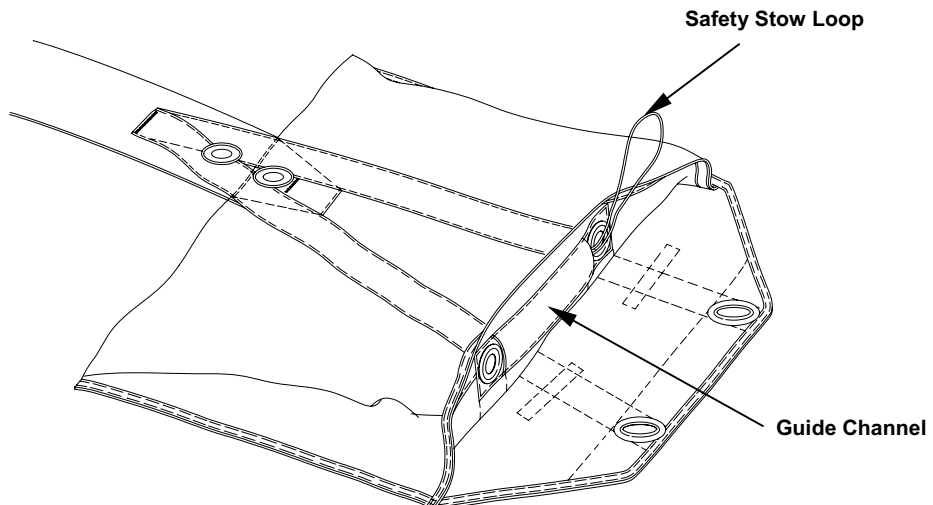

**INSTALL**

Install safety stow loop as follows:

1. Insert safety stow loop through guide channel in reserve deployment bag, centering splice on loop between grommets.

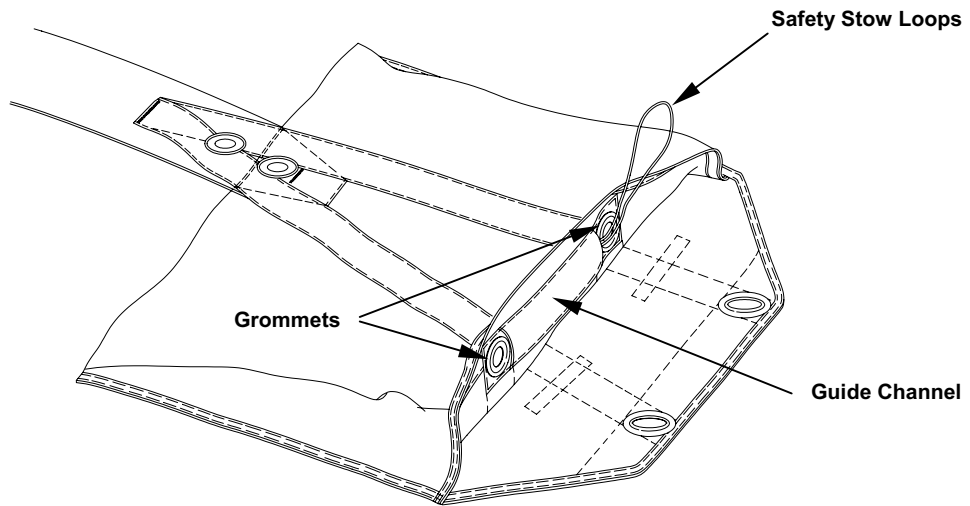

2. Thread both ends of loop up through corresponding grommets.

**END OF WORK PACKAGE**

---

**UNIT MAINTENANCE**  
**MC-4 RAM AIR FREE-FALL PERSONNEL PARACHUTE SYSTEM**  
**GENERAL CANOPY REPAIR (MAIN AND RESERVE)**

---

**THIS TASK COVERS:**

- Darning and Patching
  - Seam Repair
  - Reinforcement Tape Replacement
- 

**INITIAL SETUP:****Tools**

Sewing Machine, Bartack (Table 1, WP 0015 00)  
 Sewing Machine, Darning (Table 1, WP 0015 00)  
 Sewing Machine, Double Needle (Table 1, WP 0015 00)  
 Sewing Machine, Light-Duty (Table 1, WP 0015 00)  
 Sewing Machine, Medium-Duty (Table 1, WP 0015 00)  
 Shears (Item 39, WP 0063 00)  
 Stitch Removal Tool (Item 40, WP 0063 00)  
 Tape Measure (Item 42, WP 0063 00)

**Materials/Parts**

Cloth, Nylon Ripstop, Type I (Item 9, WP 0076 00)  
 Tape, Textile and Webbing,  $\frac{3}{8}$ -IN. Wide (Item 39, WP 0076 00)  
 Thread, Nylon, Size A (Item 45, WP 0076 00)  
 Thread, Nylon, Size E (Item 43/44, WP 0076 00)

**Equipment Condition**

Lay out on packing table or other suitable area.

**Personnel Required**

92R (10) Parachute Rigger

---

1. Darning and Patching. Repair canopy by darning, patching, or restenciling (as required) in accordance with WP 0015 00 and WP 0017 00. Stitching and darning is specified in Table 2.
2. Seam Repair. Repair seams by restitching in accordance with WP 0015 00, using a light-duty sewing machine. Use the illustrations below as a guide for construction of the applicable seam.
3. Reinforcement Tape Replace. Repair damaged reinforcement tape as follows:
  - a. Carefully remove stitches and remove damaged tape.
  - b. If adjacent canopy material is damaged, patch in accordance with WP 0015 00.
  - c. Cut new reinforcement tape 4-inches longer than damaged area. Center new reinforcement tape over damaged area. Using a light-duty sewing machine, sew in place with size E nylon thread using original stitch pattern.

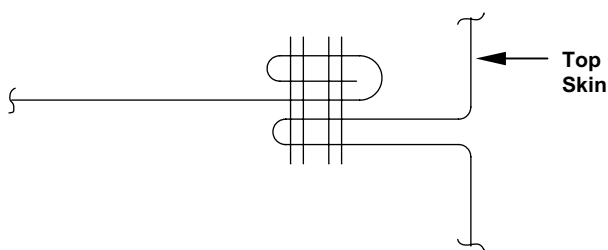

**LOADED RIB TOP SEAM**

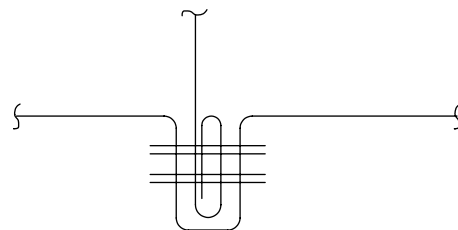

**LOADED RIB BOTTOM SEAM**

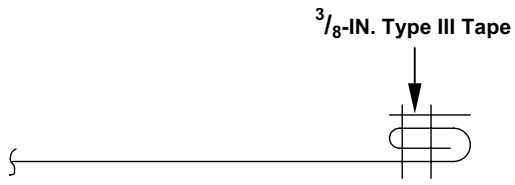

TOP NOSE SEAM

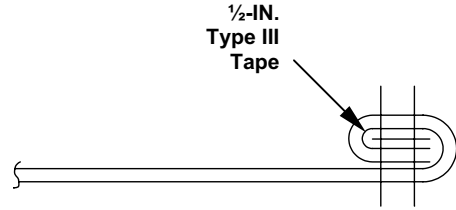

TAIL SEAM

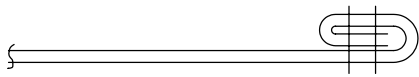

CROSS SEAM

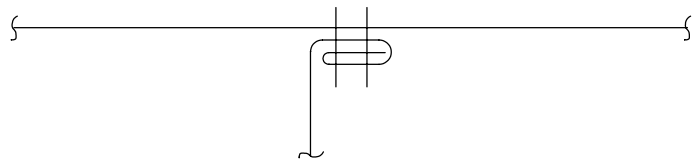

NON-LOADED RIB SEAM

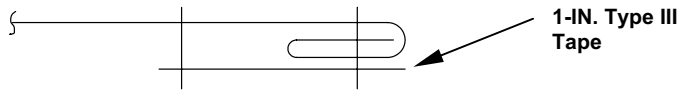

BOTTOM NOSE SEAM

END OF WORK PACKAGE



**UNIT MAINTENANCE**  
**MC-4 RAM AIR FREE-FALL PERSONNEL PARACHUTE SYSTEM**  
**MAIN CANOPY REPLACEMENT**

**THIS TASK COVERS:**

- Replace

**INITIAL SETUP:**

**Tools**

Needle, Tacking (Item 29, WP 0063 00)  
 Shears (Item 39, WP 0063 00)  
 Wrench,  $\frac{7}{16}$ -IN., Open End (Item 45, WP 0063 00)

**Material/Parts**

Parachute (Canopy), Main (Item 9, WP 0065 00)  
 Tape, Lacing and Tying (Item 33, WP 0076 00)

**Equipment Condition**

Lay out on packing table or other suitable area. Remove pilot chute, deployment bag, bridle bag, and bridle line.

**Follow-Up Procedure**

Pack Parachute (WP 0006 00)

**Personnel Required**

92R (10) Parachute Rigger

1. Remove risers from canopy as follows:
  - a. Remove control lines from toggle rings by untying overhand knots.

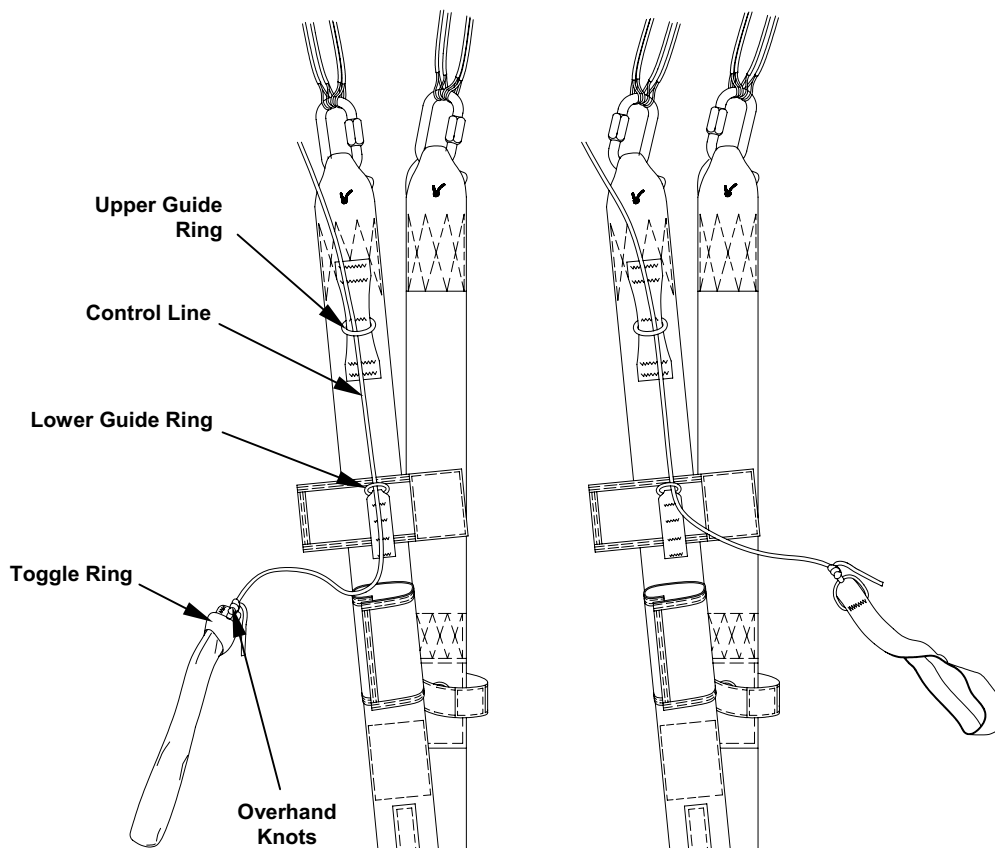

- b. Remove control lines from guide rings on rear risers.
- c. Cut and remove tacking on risers below connector links.

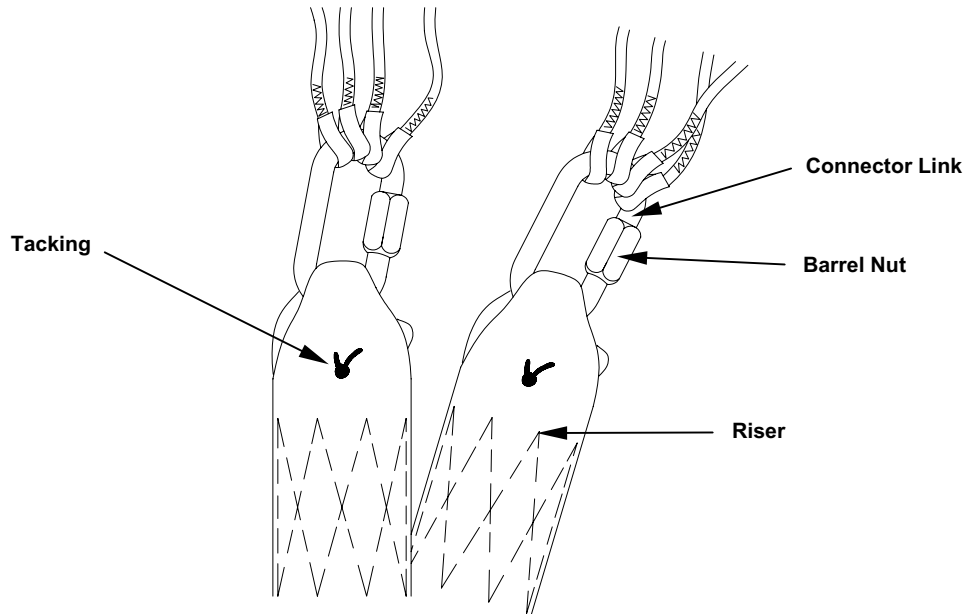

- d. Loosen barrel nuts on connector links with  $\frac{7}{16}$ -inch open-end wrench.
  - e. Remove connector links from risers.
2. Attach canopy to risers as follows:
- a. Position the connector links.

**NOTE**

Connector link barrel nuts must face inboard and tighten upward.

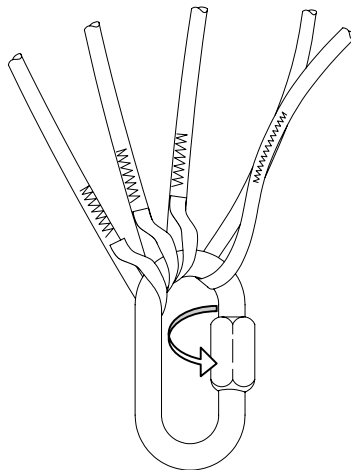

- b. Remove connector links and control lines from line organizing card and loosely connect connector links and control lines to proper riser.
- c. Using  $\frac{7}{16}$ -inch open-end wrench, tighten barrel nut on connector links  $\frac{1}{4}$  turn past hand tight.
- d. Hand tack each riser at connector link with one turn double tape lacing and tying below the connector link with an overhand knot.

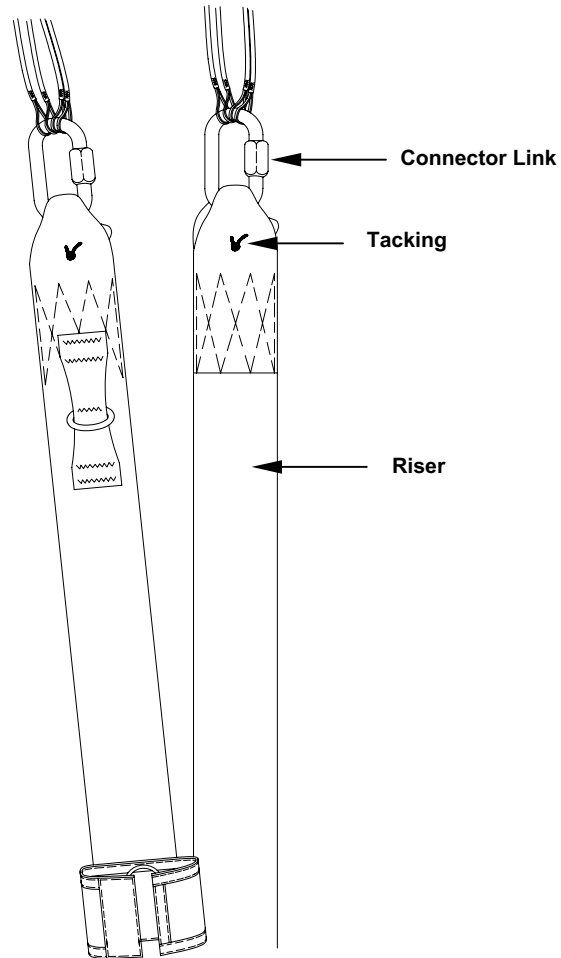

3. Perform follow-up procedures IAW WP 0006 00.

**END OF WORK PACKAGE**



---

**UNIT MAINTENANCE**  
**MC-4 RAM AIR FREE-FALL PERSONNEL PARACHUTE SYSTEM**  
**RESERVE CANOPY REPLACEMENT**

---

**THIS TASK COVERS:**

- Replace
- 

**INITIAL SETUP:**

**Tools**

Needle, Tacking (Item 29, WP 0063 00)  
 Shears (Item 39, WP 0063 00)  
 Wrench,  $\frac{7}{16}$ -IN., Open End (Item 45, WP 0063 00)

**Personnel Required**

92R (10) Parachute Rigger

**Equipment Condition**

Lay out on packing table or other suitable area.

---

**Materials/Parts**

Canopy, Reserve (Item 10, WP 0065 00)  
 Tape, Lacing and Tying (Item 33, WP 0076 00)  
 Thread, Cotton, 24/4 (Item 40, WP 0076 00)

---

**REPLACE**

1. Remove canopy from risers as follows:
  - a. Cut and remove tacking securing toggles and control lines to risers.
  - b. Remove control lines from toggle rings by untying overhand knots.

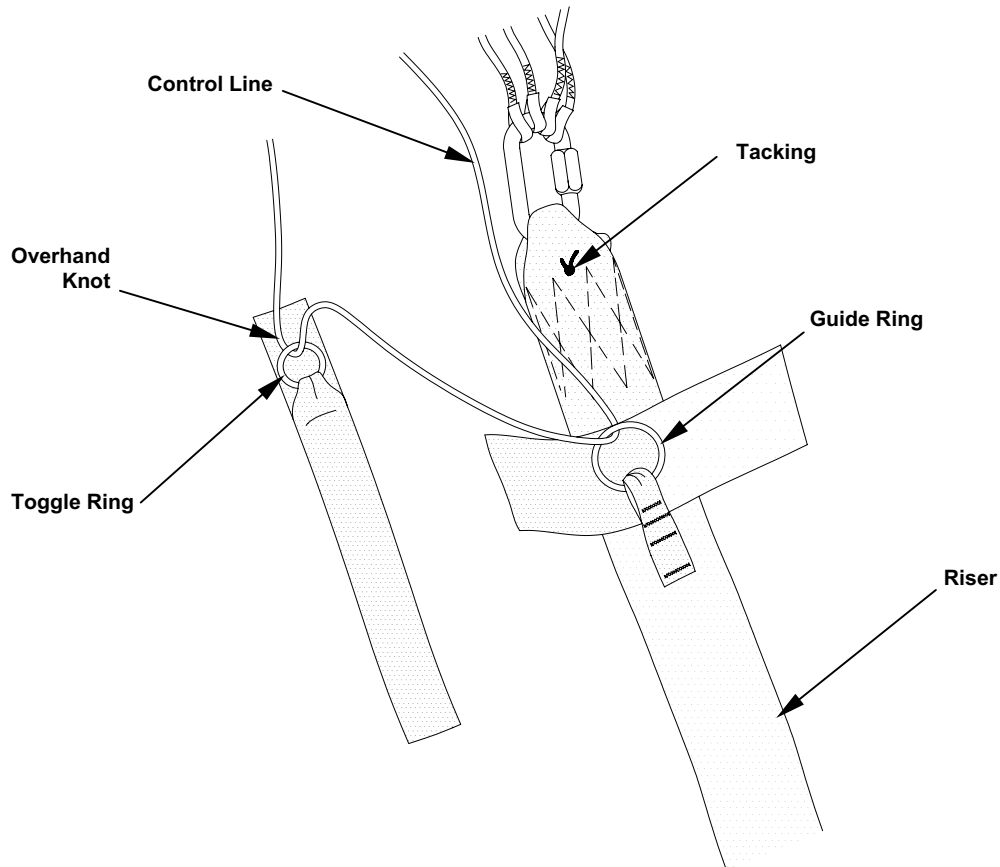

- c. Remove control lines from guide rings on rear risers.
- d. Cut and remove tacking on risers below connector links.

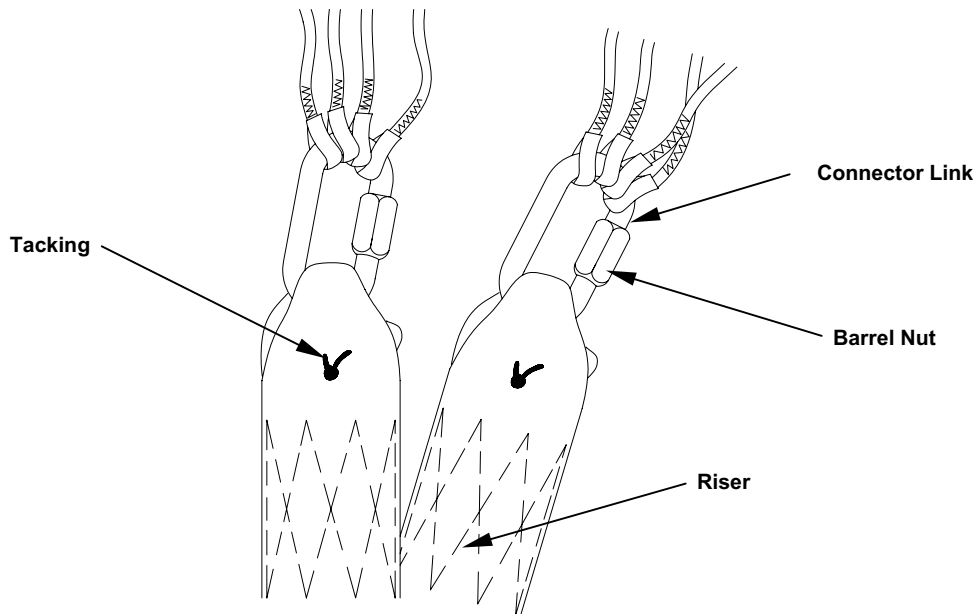

- e. Loosen barrel nuts on connector links with  $\frac{7}{16}$ -inch open-end wrench.
  - f. Remove connector links from risers.
2. Attach canopy to risers as follows:
- a. Position the connector links.

**NOTE**

Connector link barrel nuts must face inboard and tighten upward.

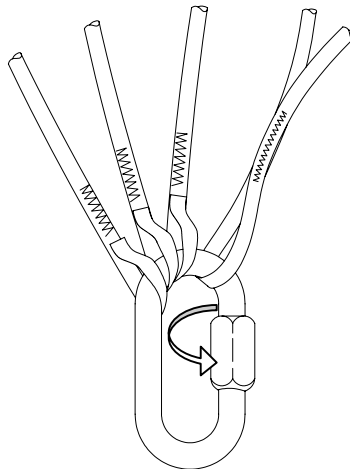

- b. Remove connector links and control lines from line organizing card and loosely connect connector links and control lines to proper riser.
- c. Using  $\frac{7}{16}$ -inch open-end wrench, tighten barrel nut on connector links  $\frac{1}{4}$  turn past hand tight.
- d. Hand tack each riser at connector link with one turn double tape lacing and tying below the connector link with an overhand knot.

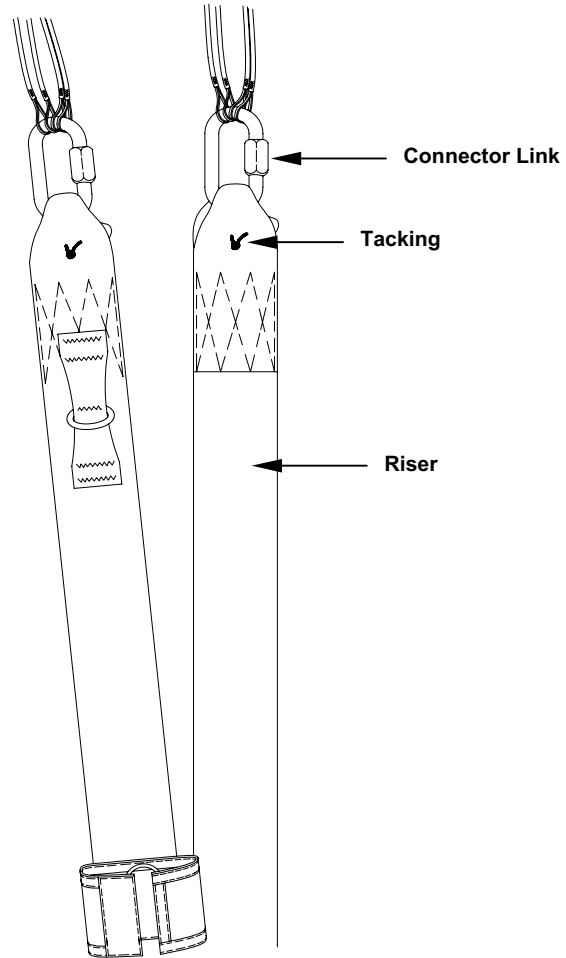

3. Perform follow-up procedures IAW WP 0005 00.

**END OF WORK PACKAGE**





---

**UNIT MAINTENANCE**  
**MC-4 RAM AIR FREE-FALL PERSONNEL PARACHUTE SYSTEM**  
**CROSSPORT MAIN OR RESERVE CANOPY**

---

**THIS TASK COVERS:**

- Patching
  - Seaming
  - Replacing
- 

**INITIAL SETUP:****Tools**

Knife, Hot Metal (Item 24, WP 0063 00)  
 Sewing Machine, Double Needle (Table 1, WP 0015 00)  
 Sewing Machine, Light-Duty (Table 1, WP 0015 00)  
 Shears (Item 39, WP 0063 00)  
 Template, Crossport, Oversized (Item 43, WP 0063 00)  
 Template, Crossport, Standard (Item 44, WP 0063 00)

**Materials/Parts**

Cloth, Nylon, Ripstop, Type I (Item 9, WP 0076 00)  
 Thread, Nylon, Size A (Item 45, WP 0076 00)  
 Thread, Nylon, Size E (Item 43/44, WP 0076 00)

---

**Personnel Required**

92R (10) Parachute Rigger

**Equipment Condition**

Layout on packing table or other suitable area.

**Follow-Up Procedure**

Continuity check and canopy trim check

---

**PATCHING CROSSPORTS**

1. Lay the rib area out on a worktable.
2. Using basic patching procedures outlined in WP 0015 00, apply the patch to the crossport as required.
3. Let the new fabric overhang the crossport on the fourth side of the patch.
4. Using a light-duty sewing machine, sew the patch with two (2) rows of size E nylon thread, 7 to 11 stitches per inch.
5. Sew a lock stitch on the raw edge side of the patch a minimum of 2-inches on each row.

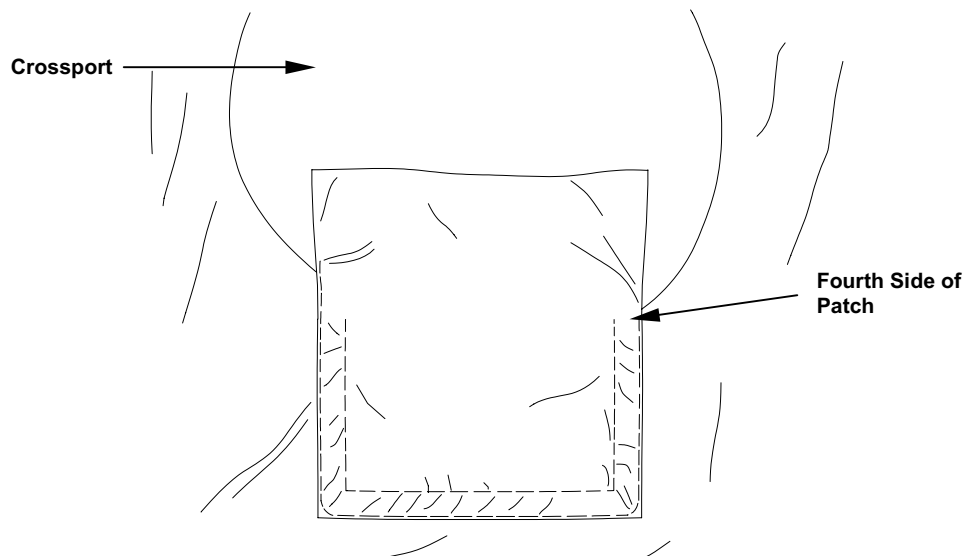

- Position a standard template over the crossport aligning the template as close to the original cut out as possible.

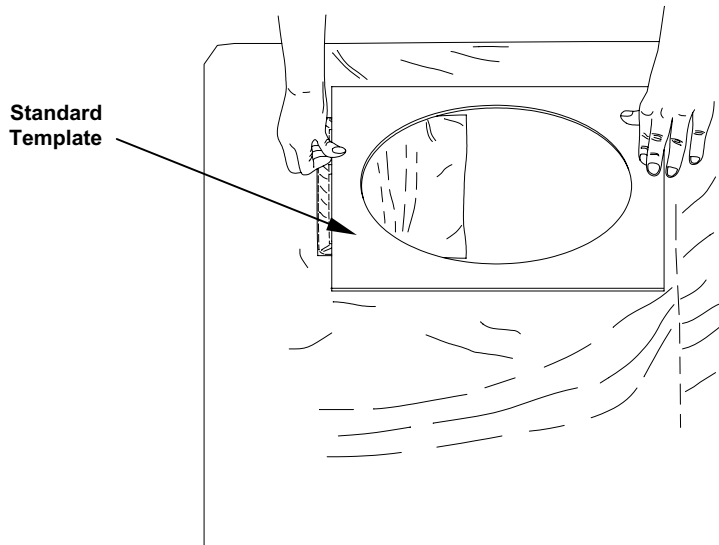

- Remove the overhanging fabric from the crossport by searing the fourth side of the patch with a hot knife.

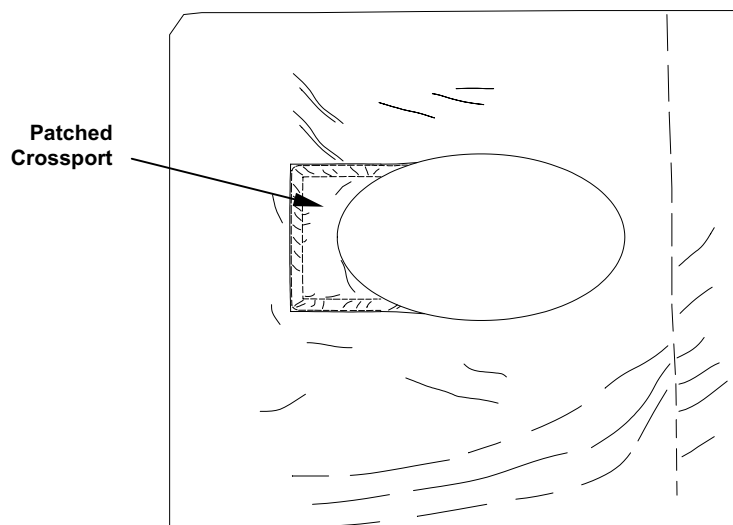

### SEARING CROSSPORTS

Searing with a hot knife can repair crossports. Sear crossports as follows:

- The maximum rip cannot exceed  $\frac{1}{2}$ -inch.
- Frayed crossports cannot exceed the oversized template.
- Lay the rib area on a non-burn surface such as a piece of tempered glass.
- Center the template and trace the inside with a hot knife.

5. Remove the rib from the tempered glass being careful not to pull the rib causing additional damage.

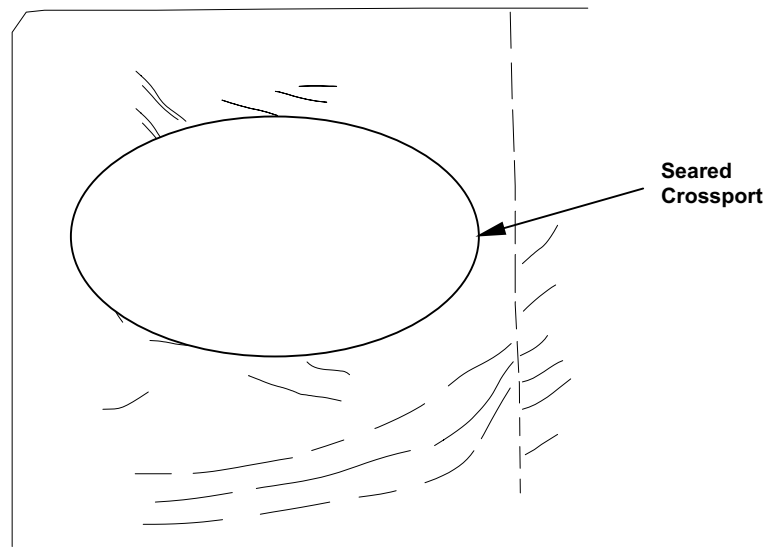

### REPLACING CROSSPORT

1. Carefully cut and remove the rib from the bottom skin exposing the damaged crossport.
2. Apply a basic patch as outlined in WP 0015 00.
3. The patch must extend from the bottom of the rib to the top.

#### NOTE

For replacing a crossport, a  $\frac{1}{4}$ -inch needle gauge and a double needle sewing machine with cloth/fabric puller attachment is recommended.

4. Using either a light-duty single needle sewing machine or a double needle light/medium-duty sewing machine with cloth/fabric puller attachment, re-sew the rib to the top and bottom skin using size E nylon thread, and 7 to 11 stitches per inch.
5. Using a standard size template and hot knife, carefully cut a new crossport into the new fabric as close to the original construction as possible.

### END OF WORK PACKAGE



---

**UNIT MAINTENANCE**  
**MC-4 RAM AIR FREE-FALL PERSONNEL PARACHUTE SYSTEM**  
**STABILIZER LEFT OR RIGHT, MAIN OR RESERVE CANOPY**

---

**THIS TASK COVERS:**

- Replace
- 

**INITIAL SETUP:****Tools**

Sewing Machine, Bartack (Table 1, WP 0015 00)  
 Sewing Machine, Double Needle (Table 1, WP 0015 00)  
 Sewing Machine, Light-Duty (Table 1, WP 0015 00)  
 Shears (Item 39, WP 0063 00)

**Personnel Required**

92R (10) Parachute Rigger

**Equipment Condition**

Layout on packing table or other suitable area.

**Materials/Parts**

Stabilizer, Left (Item 13, WP 0068 00)  
 Stabilizer, Right (Item 12, WP 0068 00)  
 Tape, Nylon, 2-IN. Wide (Item 35, WP 0076 00)  
 Thread, Nylon, Size E (Item 43/44, WP 0076 00)

---

**REPLACE**

1. Carefully cut and remove the bartack securing the suspension lines to the stabilizer.
2. Carefully cut and remove the bartack securing the stabilizer.
3. Remove the stabilizer.
4. Obtain a replacement stabilizer from supply.
5. If the new stabilizer does not have the 2-inch nylon tape on both sides, apply the tape on the two (2) most forward slider stops (B & C line only) using the following procedures:
  - a. Cut a 9-inch piece of 2-inch nylon tape. Measure and fold webbing under 2 ½-inches from each end forming a 4-inch length.

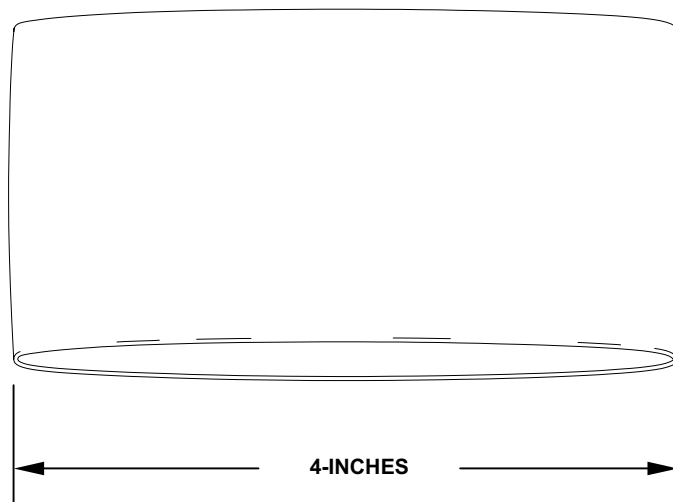

- b. Using a light-duty sewing machine, size E nylon thread and 7 to 11 stitches per inch, sew the 2-inch nylon tape to the inside of the stabilizer directly over the 2-inch tape on the outside.

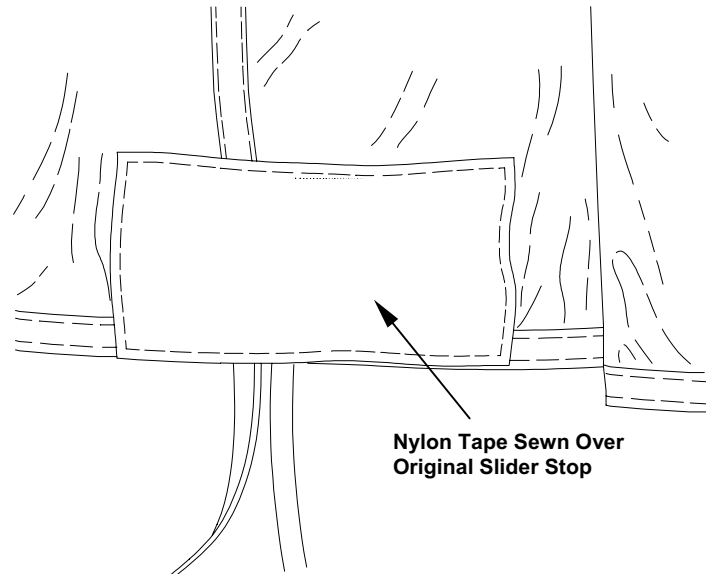

6. Using a double needle sewing machine with cloth puller, size E nylon thread, and 7 to 11 stitches per inch, re-sew the stabilizer to the canopy.
7. Using a 42-stitch bartack sewing machine and size E nylon thread, bartack the stabilizer as close to the original construction and stitch formation as possible.
8. Using a 42-stitch bartack sewing machine and size E nylon thread, bartack the suspension line and slider stops as close to the original construction and stitch formation as possible.

**END OF WORK PACKAGE**

---

**UNIT MAINTENANCE**  
**MC-4 RAM AIR FREE-FALL PERSONNEL PARACHUTE SYSTEM**  
**TAIL SEAM MAIN OR RESERVE CANOPY**

---

**THIS TASK COVERS:**

- Repair
- 

**INITIAL SETUP:**

**Tools**

Sewing Machine, Bartack (Table 1, WP 0015 00)  
Sewing Machine, Light-Duty (Table 1, WP 0015 00)  
Shears (Item 39, WP 0063 00)  
Stitch Removal Tool (Item 40, WP 0063 00)

**Personnel Required**

92R (10) Parachute Rigger

**Equipment Condition**

Layout on packing table or other suitable area.

**Material/Parts**

Cloth, Nylon, Ripstop, Type I (Item 9, WP 0076 00)  
Thread, Nylon, Size E (Item 43/44 WP 0076 00)

---

**REPAIR**

**CAUTION**

If needed, only one pleat between ribs is authorized on the top seam to align the ribs (pleat should be centered between two (2) ribs, with a maximum size of 1-inch).

1. Patch the top skin or bottom skin as required using miscellaneous canopy patching procedures outlined in WP 0015 00.
2. Carefully cut stitching securing the tail seam together.
3. If required, carefully cut stitching securing the rib to the tail seam.
4. If required, carefully cut the control line-attaching loop and lay aside.
5. Re-sew items removed above, in reverse order, using a light-duty sewing machine, size E nylon thread and 7 to 11 stitches per inch.

**END OF WORK PACKAGE**





---

**UNIT MAINTENANCE**  
**MC-4 RAM AIR FREE-FALL PERSONNEL PARACHUTE SYSTEM**  
**SLIDER MAIN AND RESERVE CANOPY**

---

**THIS TASK COVERS:**

- Repair
  - Replace
- 

**INITIAL SETUP:****Tools**

Die Set, Spur Grommet No. 8 (Item 13, WP 0063 00)  
Mallet, Rawhide (Item 27, WP 0063 00)  
Needle, Tacking (Item 29, WP 0063 00)  
Pliers, Large, Diagonal Cut (Item 32, WP 0063 00)  
Sewing Machine, Darning (Table 1, WP 0015 00)  
Sewing Machine, Light-Duty (Table 1, WP 0015 00)  
Sewing Machine, Medium-Duty (Table 1, WP 0015 00)  
Shears (Item 39, WP 0063 00)  
Tape Measure (Item 42, WP 0063 00)  
Wrench, <sup>7</sup>/<sub>16</sub>-IN., Open End (Item 45, WP 0063 00)

**Equipment Condition**

Lay out on packing table or other suitable area. Control lines removed from riser guide rings.

**Personnel Required**

92R (10) Parachute Rigger

**Follow-Up Procedure**

Initial receipt (WP 0004 00)

**Materials/Parts**

Cloth, Nylon, Ripstop, Type I (Item 9, WP 0076 00)  
Tape, Lacing and Tying (Item 33, WP 0076 00)  
Thread, Nylon, Size A (Item 45, WP 0076 00)  
Thread, Nylon, Size E (Item 43/44, WP 0076 00)

---

**REPAIR**

Slider repair is limited to restitching, darning, patching (basic patch only), and grommet replacement.

Restitching, darning, and patching. Repair slider by restitching, darning, or patching (basic patch only) in accordance with WP 0015 00. Darning is limited to two darns per slider; patching is limited to one basic patch per slider.

**REPLACE**

1. Grommet replace. Replace damaged grommets as follows:

---

**NOTE**

No reinforcement of fabric around grommet hole is permitted. If a grommet cannot be replaced without reinforcement, slider replacement is required.

- a. Cut crimped edge of damaged grommet at three or four points.
  - b. Remove grommet and washer.
  - c. Lock replacement grommet and grommet washers in place with die set.
2. Replace unserviceable slider as follows:
- a. Cut and remove tacking from risers.

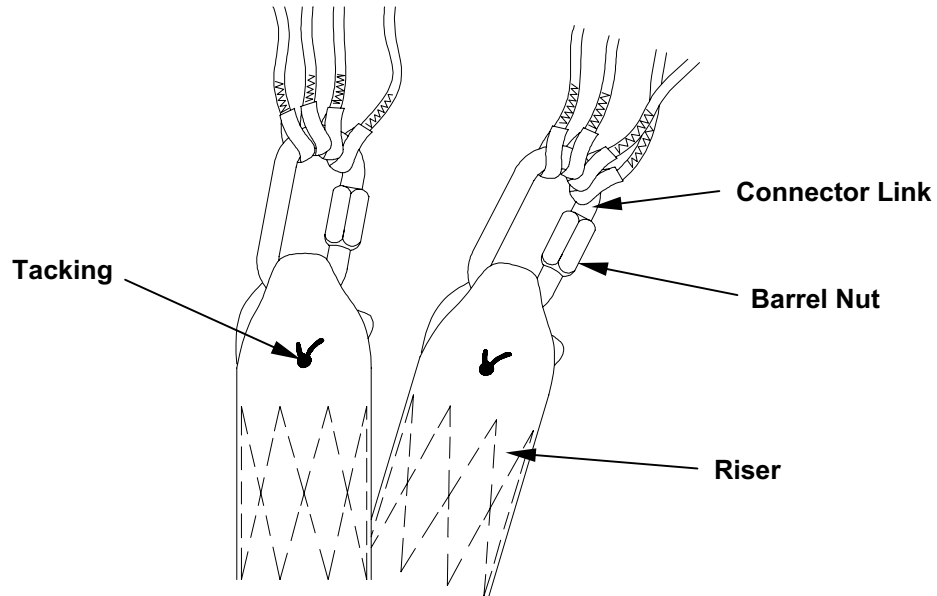

- b. Using a  $\frac{7}{16}$ -inch open-end wrench, loosen barrel nuts on connector links and remove risers.
- c. Remove connector links and control lines from risers.
- d. Remove slider from suspension lines and control lines.

**NOTE**

Ensure 28-inch side of slider faces to front or leading edge of canopy.

- e. Insert suspension lines, control lines, and connector links through corresponding grommets on slider. Slider is installed with reinforcement tapes facing toward canopy.

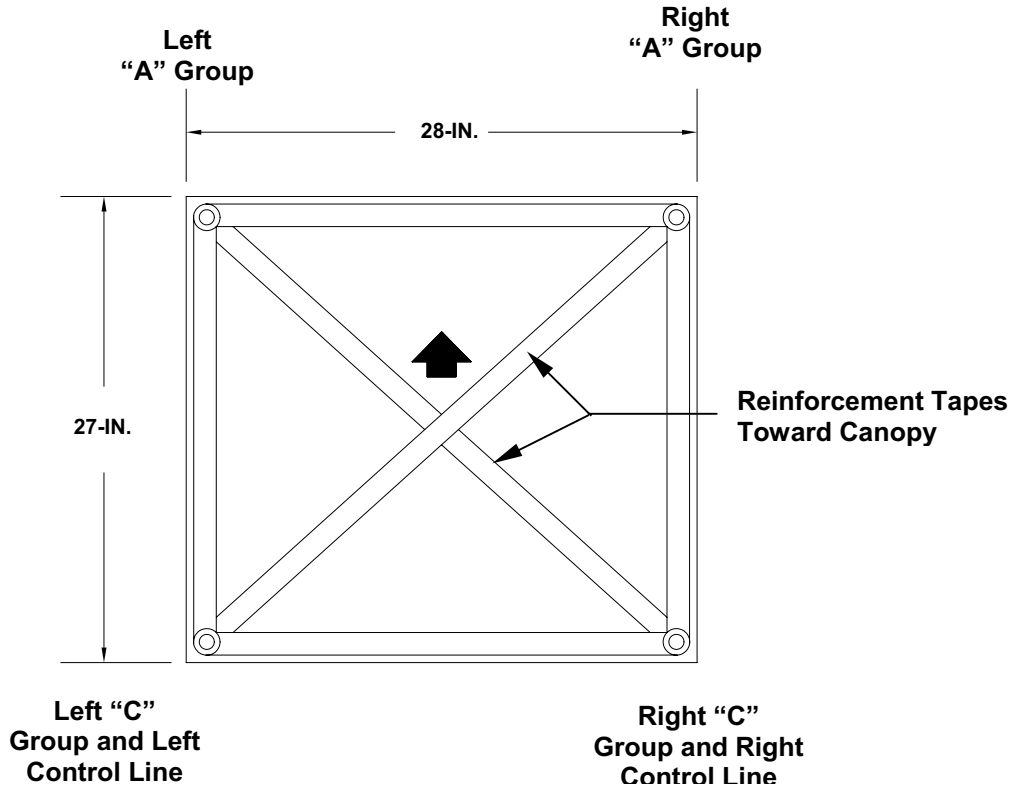

- f. Position connector links so that barrels face inboard and tighten upward.

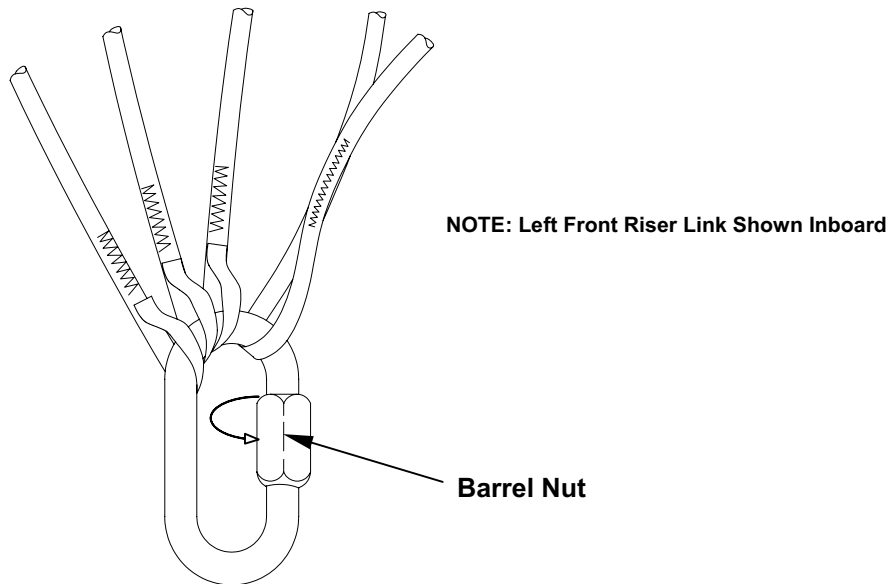

- g. Install risers onto applicable connector links.

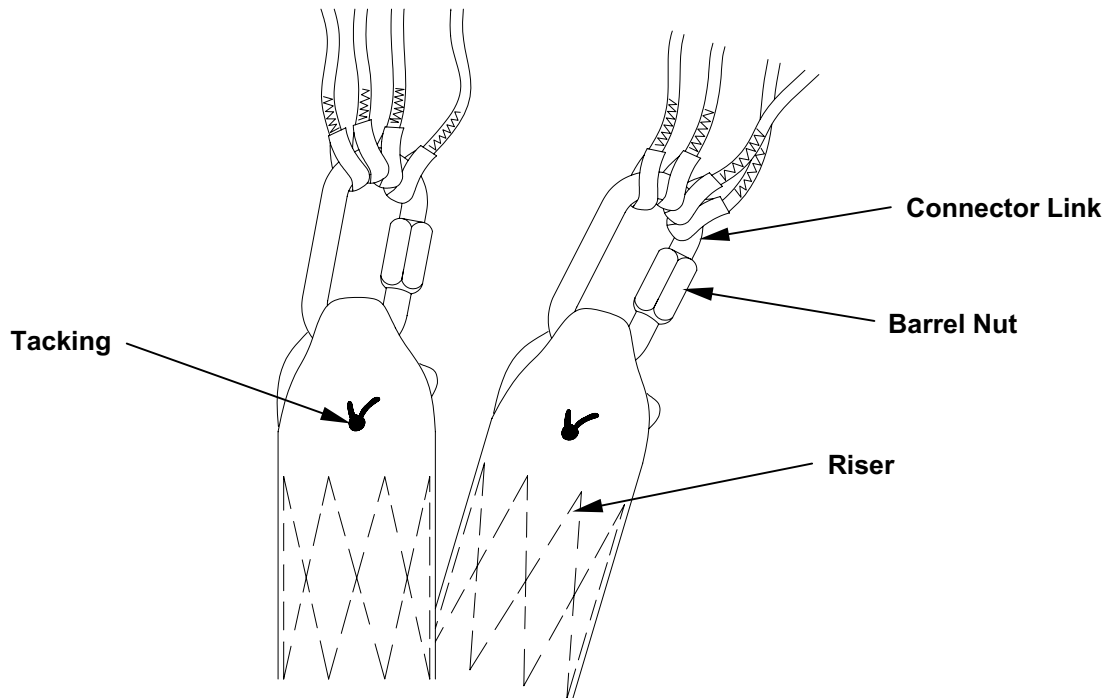

- h. Using a  $\frac{7}{16}$ -inch open-end wrench, tighten barrel nuts on connector links  $\frac{1}{4}$  turn past hand tight.
- i. Hand-tack each riser at connector link with one turn double nylon lacing tape.
- j. Perform follow-up procedure (WPs 0005 00 and 0006 00).

**END OF WORK PACKAGE**

---

**UNIT MAINTENANCE**  
**MC-4 RAM AIR FREE-FALL PERSONNEL PARACHUTE SYSTEM**  
**SLIDER STOP MAIN AND RESERVE CANOPY**

---

**THIS TASK COVERS:**

- Repair
- 

**INITIAL SETUP:****Tools**

Sewing Machine, Bartack (Table 1, WP 0015 00)  
Sewing Machine, Light-Duty (Table 1, WP 0015 00)  
Shears (Item 39, WP 0063 00)  
Stitch Removal Tool (Item 40, WP 0063 00)

**Personnel Required**

92R (10) Parachute Rigger

**Equipment Condition**

Layout on packing table or other suitable area.

**Materials**

Tape, Nylon, 2-IN. Wide (Item 35, WP 0076 00)  
Tape, Textile & Webbing,  $\frac{3}{8}$ -IN. Wide (Item 39, WP 0076 00)  
Thread, Nylon, Size E (Item 43/44, WP 0076 00)

---

**REPAIR****NOTE**

Mark a line at the bottom edge of the stabilizer before removing.  
This will aid in the re-attachment of the stabilizer.

1. Carefully cut and remove bartack stitching securing suspension line to stabilizer. Should the suspension line sustain damage during removal, it must be replaced IAW WP 0055 00.
2. Remove the 2-inch nylon tape.
3. Remove enough of the horizontal and vertical  $\frac{3}{8}$ -inch nylon tape to expose the damaged area and allow for patching.
4. Patch the stabilizer using procedures outlined in WP 0015 00 applying a basic or miscellaneous patch.
5. Ensure the patch is sewn to the inside of the stabilizer panel (the side the suspension line is sewn to).
6. Re-sew the vertical  $\frac{3}{8}$ -inch nylon tape back into place, using a light-duty sewing machine, size E nylon thread and 7 to 11 stitches per inch.
7. Re-sew the horizontal  $\frac{3}{8}$ -inch nylon tape back into place using a light-duty sewing machine, size E nylon thread and 7 to 11 stitches per inch.

8. Cut a 9-inch piece of 2-inch nylon tape. Measure and fold webbing under 2 ½-inches from each end forming a 4-inch length.

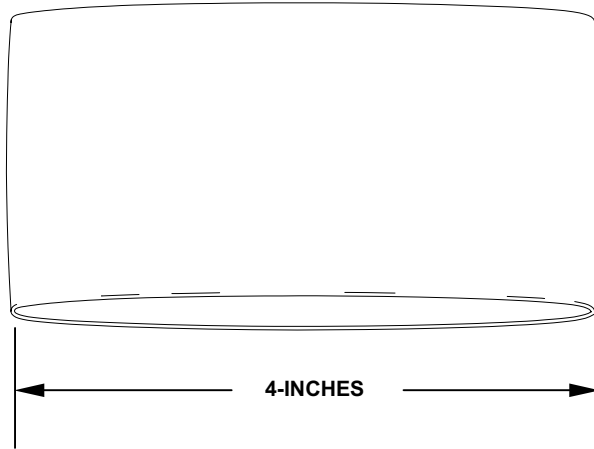

9. Position the plastic slider stop between the top two layers of the 2-inch webbing.
10. Using a light-duty sewing machine, size E nylon thread and 7 to 11 stitches per inch, sew the slider stop to the previously patched area on the outside of stabilizer ensuring the slider stop is positioned on the correct side of the vertical  $\frac{3}{8}$ -inch nylon tape (the first two plastic slider stops are on the rear of the vertical  $\frac{3}{8}$ -inch nylon tape, the last plastic slider stop is to the front of the vertical  $\frac{3}{8}$ -inch nylon tape). Ensure the 2-inch nylon tape is of equal distance on each side of the vertical  $\frac{3}{8}$ -inch nylon tape.

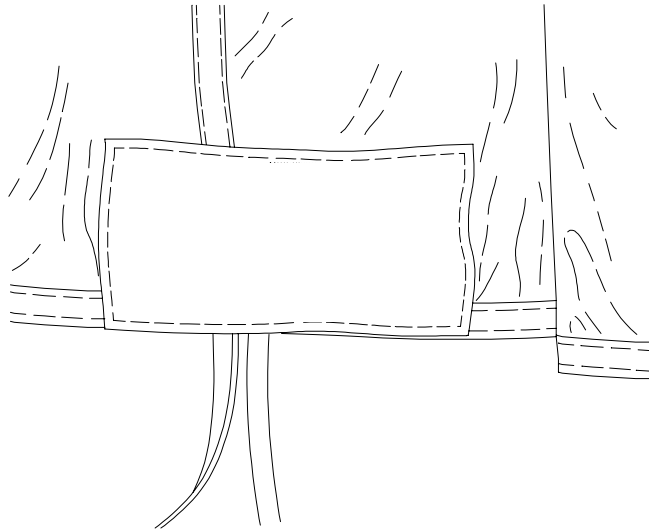

11. Obtain an additional 9-inch piece of 2-inch nylon tape from supply stock and fold it in the same manner as stated in step 8., above.
12. Using a light-duty sewing machine, size E nylon thread and 7 to 11 stitches per inch, sew the 2-inch nylon tape to the inside of the stabilizer, directly over the 2-inch tape on the outside of the stabilizer.

- Using a 42-stitch bartack sewing machine and size E nylon thread, bartack the suspension line back into place in accordance with original construction and stitch formation.

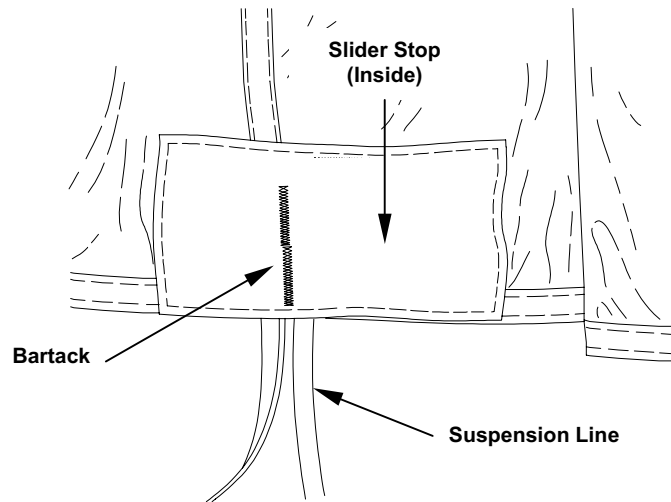

**NOTE**

Stabilizer float is 1/2-inch on B line, 1-inch on C line and 1 1/2-inches on D line.

- Using a 42-stitch bartack sewing machine and size E nylon thread, bartack the slider stop on the three sides of the 2-inch nylon tape in accordance with original construction and stitch formation.

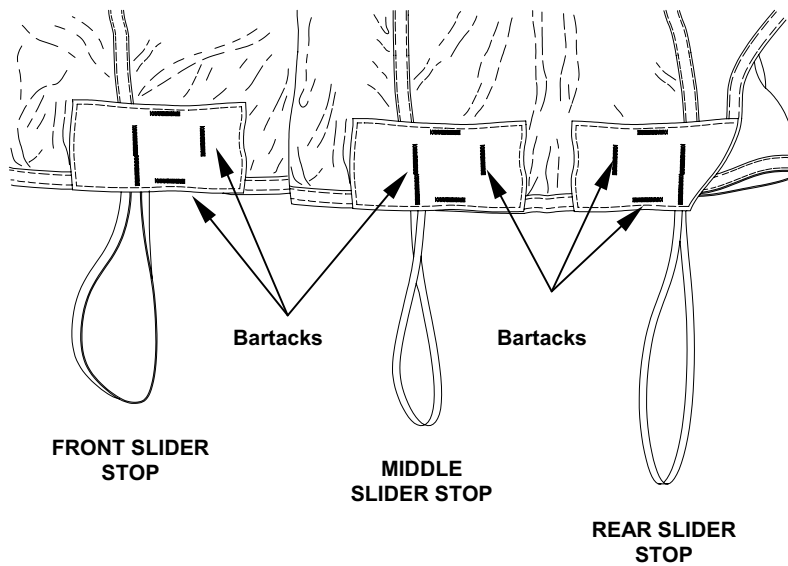

**END OF WORK PACKAGE**





**UNIT MAINTENANCE**  
**MC-4 RAM AIR FREE-FALL PERSONNEL PARACHUTE SYSTEM**  
**CONNECTOR LINKS MAIN AND RESERVE CANOPY**

**THIS TASK COVERS:**

- Replace

**INITIAL SETUP:**

**Tools**

Needle, Tacking (Item 29, WP 0063 00)  
 Shears (Item 39, WP 0063 00)  
 Wrench,  $\frac{7}{16}$ -IN., Open End (Item 45, WP 0063 00)

**Materials/Parts**

Link, Connector (Item 7, WP 0069 00)  
 Tape, Lacing and Tying (Item 33, WP 0076 00)

**Equipment Condition**

Lay out on packing table or other suitable area.

**Personnel Required**

92R (10) Parachute Rigger

**Follow-Up Procedure**

Initial receipt (WPs 0005 00 and 0006 00)

**REPLACE**

1. Cut and remove tacking from risers.

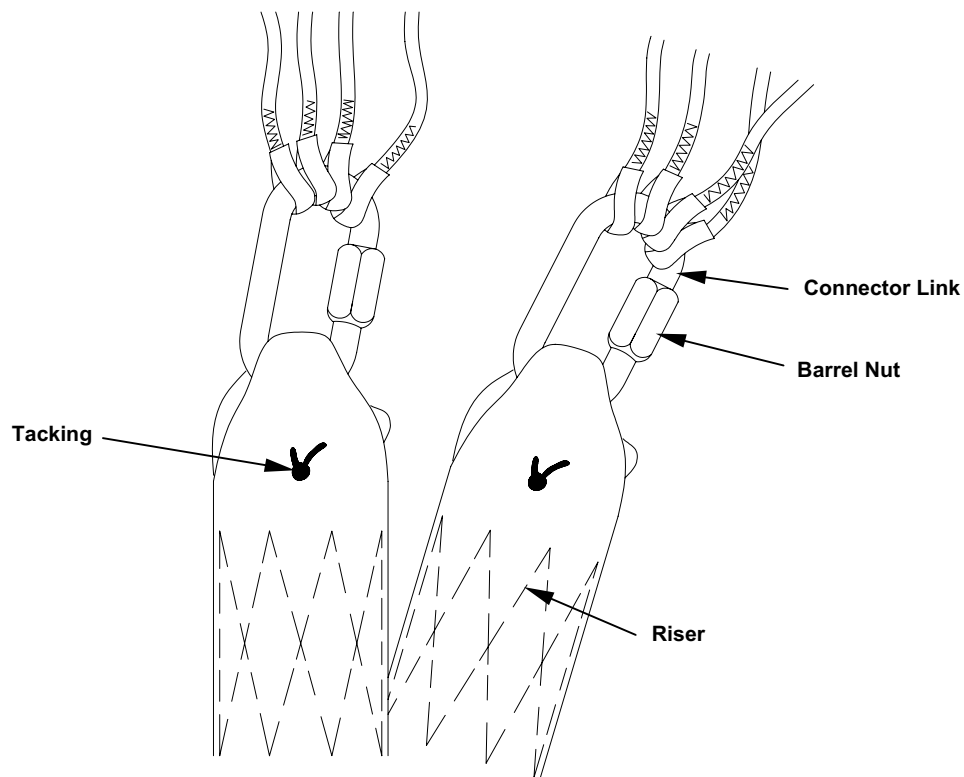

2. Using a  $\frac{7}{16}$ -inch open-end wrench, loosen barrel nuts on connector links and remove risers.
3. Remove suspension lines from connector links and discard unserviceable links.

4. Position replacement links so that barrels face Inboard and tighten upward. Attach suspension lines to their corresponding connector links without crossing.

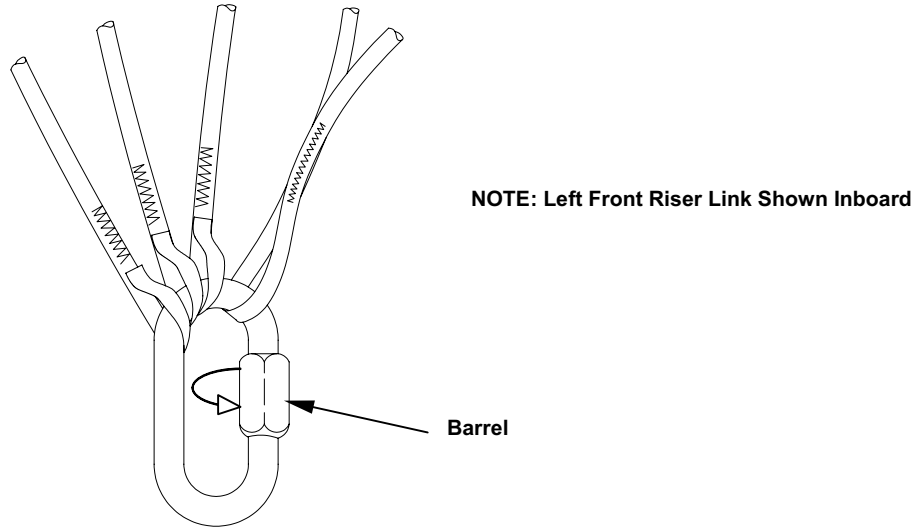

5. Install risers onto applicable connector links.

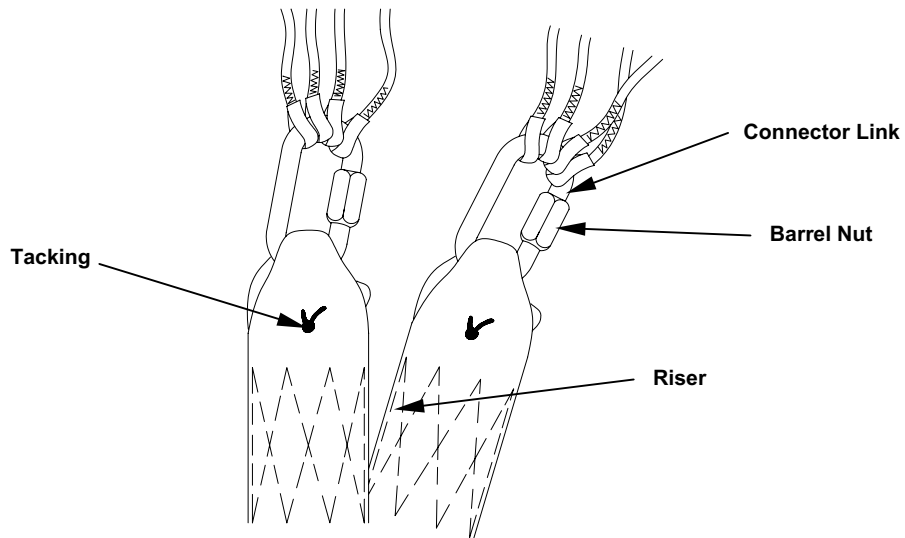

6. Using a  $\frac{7}{16}$ -inch open-end wrench, tighten barrel nuts on connector links  $\frac{1}{4}$  turn past hand tight.
7. Hand tack each riser at connector link with one turn double, tape, lacing and tying.
8. Perform follow-up procedure (WPs 0005 00 and 0006 00).

**END OF WORK PACKAGE**

**UNIT MAINTENANCE**  
**MC-4 RAM AIR FREE-FALL PERSONNEL PARACHUTE SYSTEM**  
**MAIN RISERS**

**THIS TASK COVERS:**

- Replace

**INITIAL SETUP:**

**Tools**

- Needle, Tacking (Item 29, WP 0063 00)
- Shears (Item 39, WP 0063 00)
- Wrench, Open End, <sup>7</sup>/<sub>16</sub>-IN. (Item 45, WP 0063 00)

**Materials/Parts**

- Riser Set, Main, 3-Ring (Item 11, WP 0065 00)
- Tape, Lacing and Tying (Item 33, WP 0076 00)

**Personnel Required**

92R (10) Parachute Rigger

**Equipment Condition**

Lay out on packing table or other suitable area.

**Follow-Up Procedure**

Initial receipt (WP 0006 00)

**REPLACE**

**NOTE**

Risers will be replaced in pairs.

1. Remove overhand knots on rear riser control toggles.

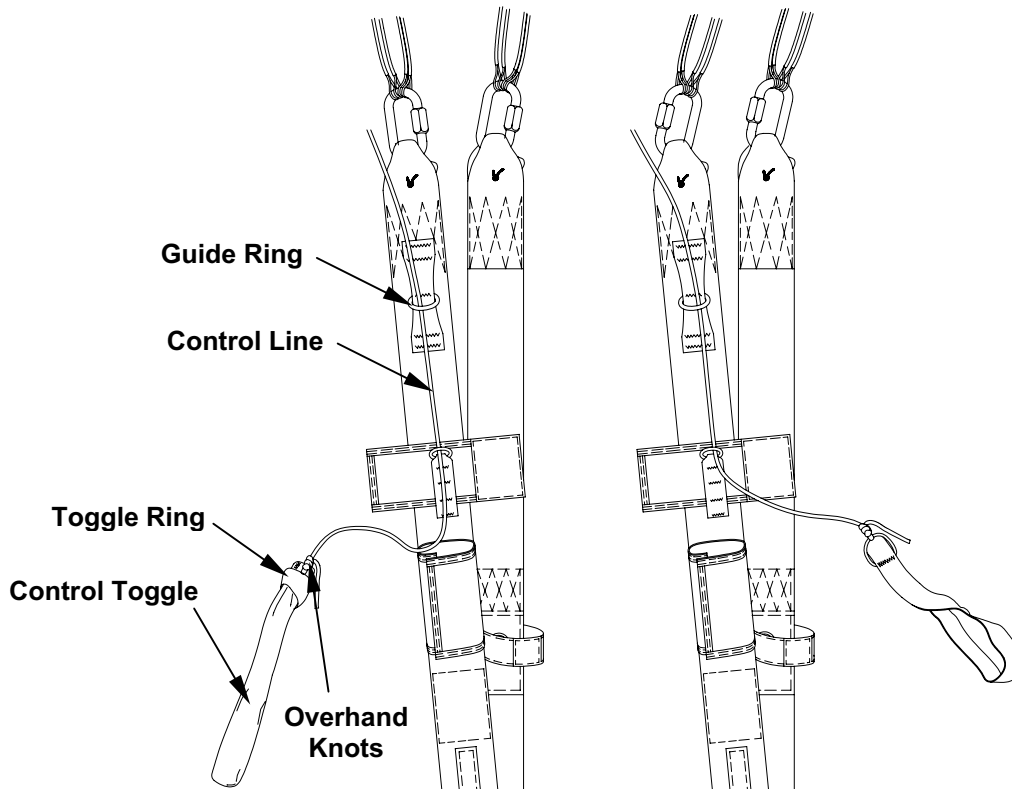

2. Pull control lines up through toggle rings and guide rings.
3. Cut and remove tacking from unserviceable risers.

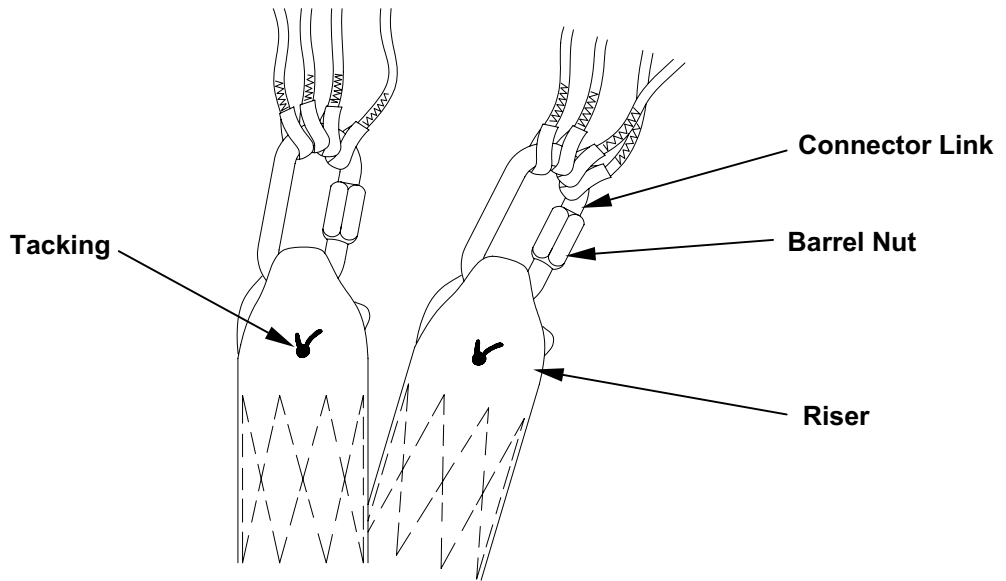

4. Using a  $\frac{7}{16}$ -inch open end wrench, loosen barrel nuts on connector links and remove risers.
5. Open snap fastener on reserve static line shackle.

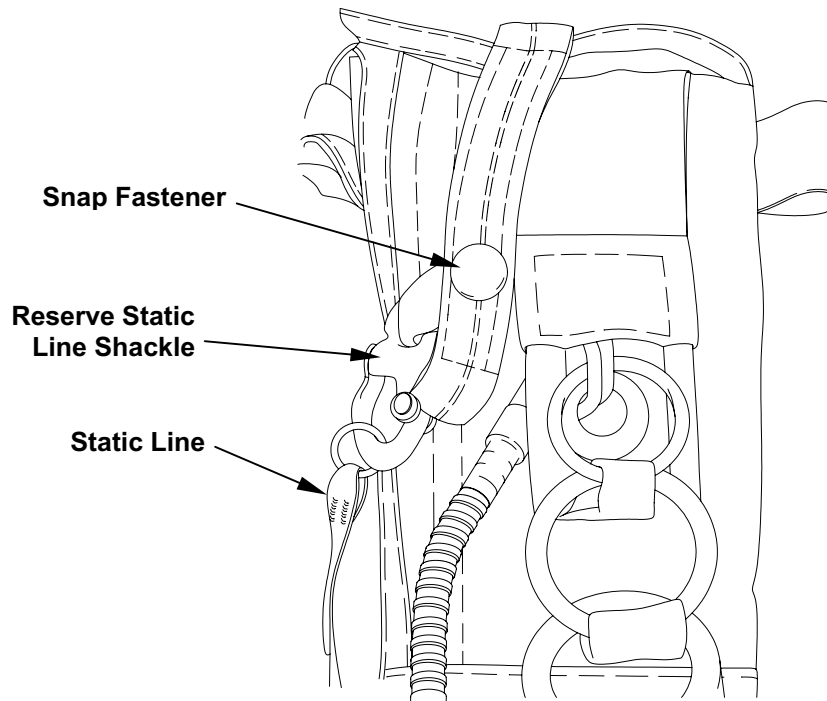

6. Remove static line from shackle.
7. Pull main canopy release ripcord. This allows the two rings on the risers to disengage from base ring and complete removal of risers.
8. Test replacement risers in accordance with WP 0011 00.
9. Compare replacement risers, ensuring there is not more than  $\frac{1}{2}$ -inch difference in length.

**CAUTION**

Ensure Clearslip #2™ Silicone Lubricant does not come in contact with any textile surface of the MC-4 RAPPs.

10. Apply a small amount of Clearslip #2™ silicone lubricant to a clean dry rag and wipe each single point release cable several times. Allow a few moments for evaporation. Route main canopy release cables through appropriate housings. Mate hook fastener on main canopy release ripcord to pile fastener on main ripcord pocket.

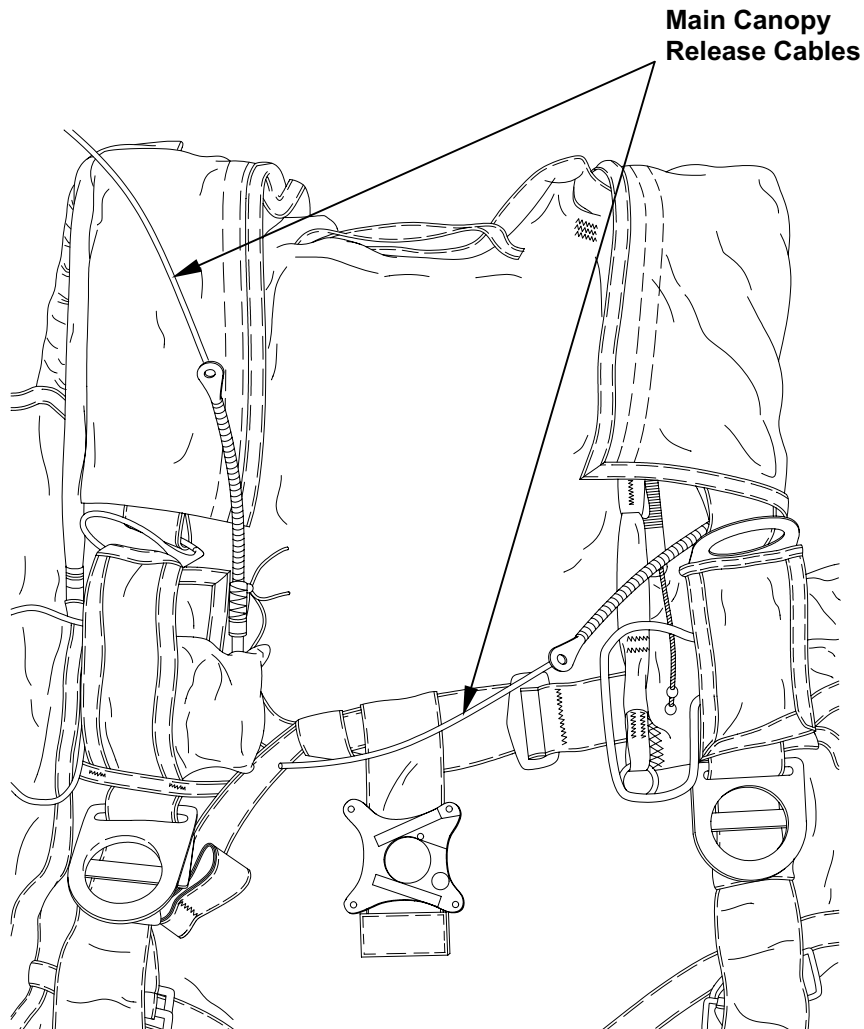

11. Position left riser on left side of harness and right riser on right side of harness.
12. Position medium sized ring on riser behind and through base ring on harness; then rotate upward.

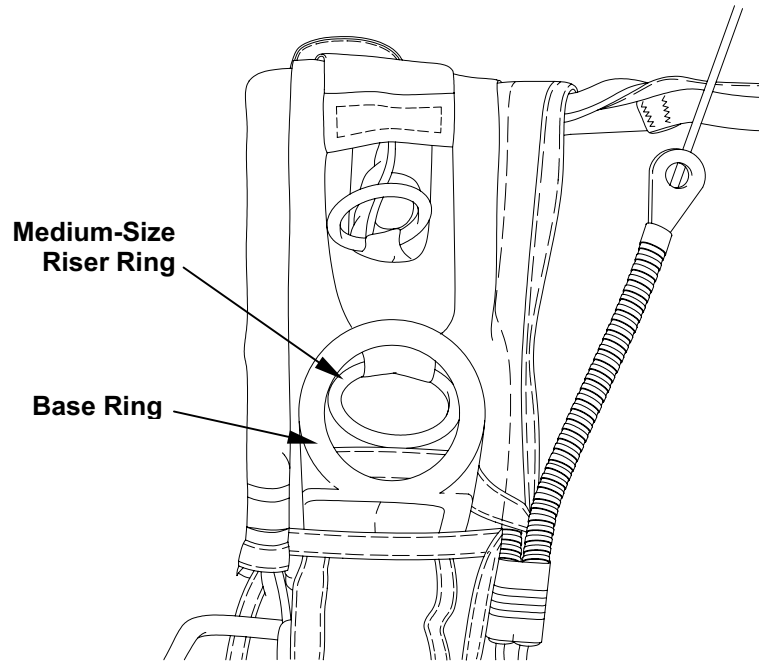

13. Position small ring on riser behind and through medium sized ring on riser; then rotate upward.

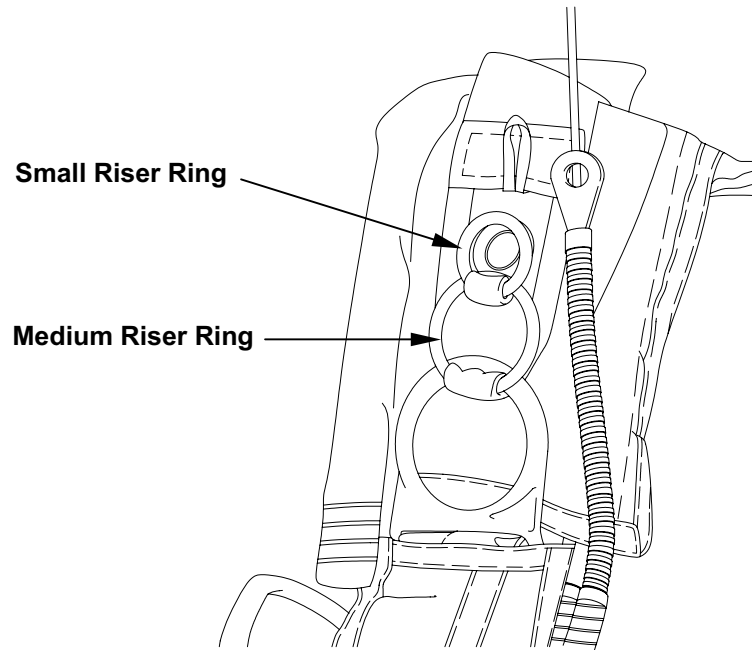

14. Route locking loop over and through small ring, then down through grommet on riser.

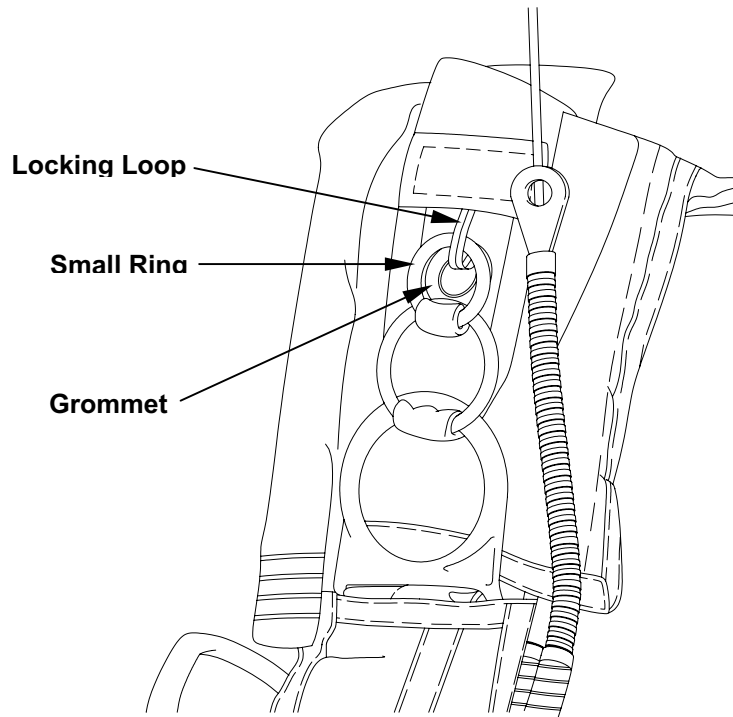

15. Route locking loop through end fitting of main canopy release housing. Ensure flat portion of end fitting is against riser. Route main canopy release cable through locking loop.

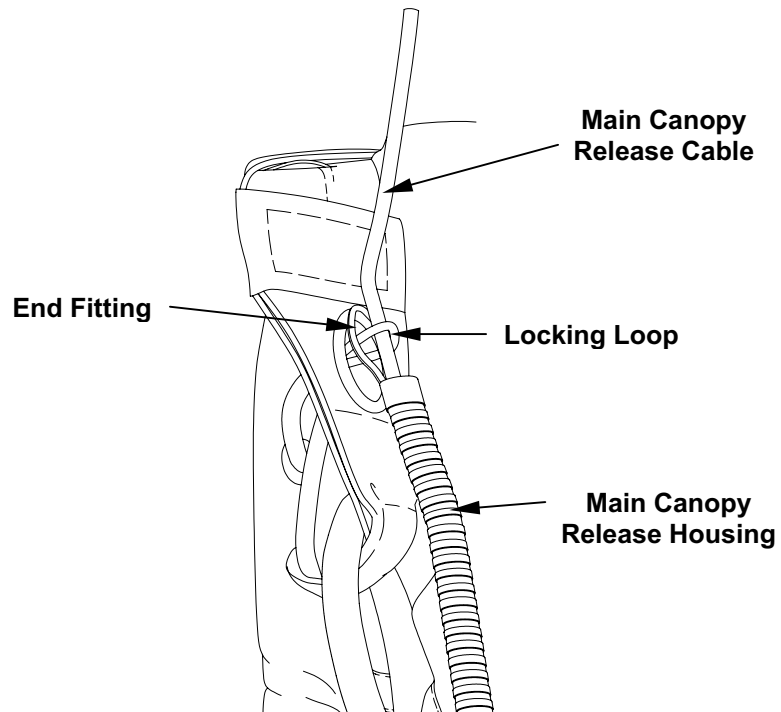

**NOTE**

Ensure riser locking loop is not twisted.

16. Pull main canopy release cable completely through locking loop and stow in channel provided on riser.

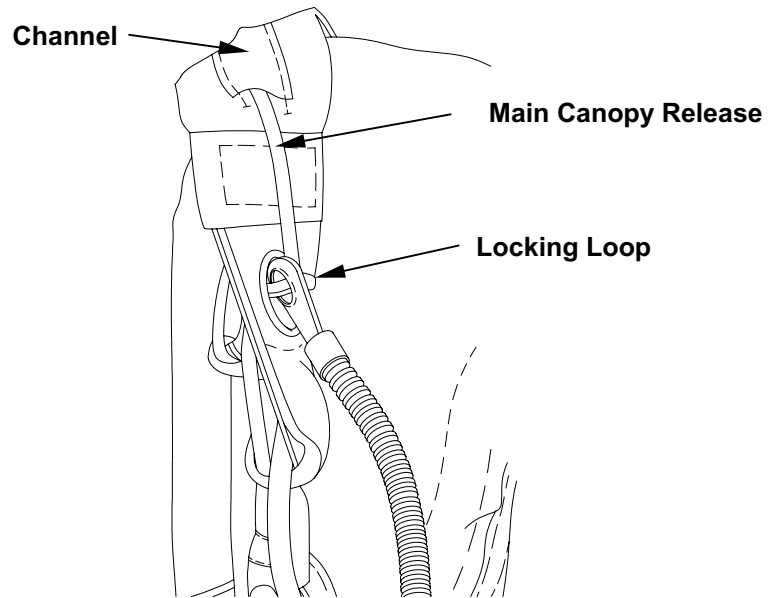

17. Repeat steps 9. through 16. to attach the other riser.

18. Install static line in shackle and close snap fastener.

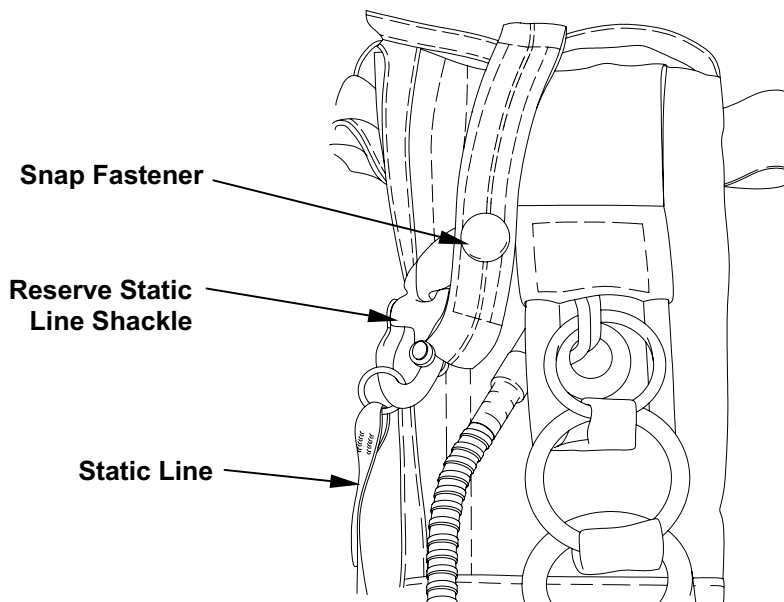



19. Attach main risers to the main canopy IAW WP 0006 00.
20. Perform follow-up procedure (WP 0006 00).

**END OF WORK PACKAGE**



---

**UNIT MAINTENANCE**  
**MC-4 RAM AIR FREE-FALL PERSONNEL PARACHUTE SYSTEM**  
**MAIN CANOPY RELEASE CABLE CHANNEL**

---

**THIS TASK COVERS:**

- Repair
  - Replace
- 

**INITIAL SETUP:****Tools**

Sewing Machine, Light-Duty (Table 1, WP 0015 00)  
 Shears (Item 39, WP 0063 00)  
 Stitch Removal Tool (Item 40, WP 0063 00)

**Equipment Condition**

Lay out on packing table or other suitable area.

**Materials/Parts**

Tape, Nylon, Type III, Class I,  $\frac{3}{4}$ -IN. Wide (Item 37, WP 0076 00)  
 Thread, Nylon, Size E (Item 43/44, WP 0076 00)

**Personnel Required**

92R (10) Parachute Rigger

---

**REPAIR**

If loose or broken threads are present, restitch with size E nylon thread in accordance with WP 0015 00.

**REPLACE**

Replace damaged release cable channel as follows:

1. Remove damaged nylon tape by carefully removing stitching securing it to riser.

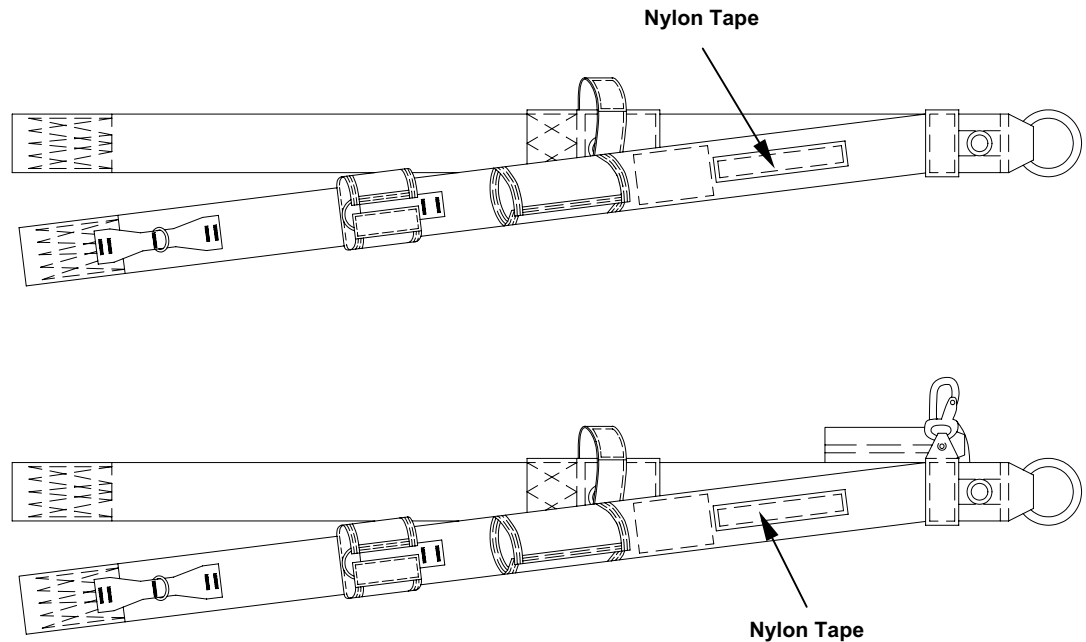

2. Using a 7-inch length of nylon tape, locate replacement tape directly over location where previously removed.
3. Fold ends of tape under 1/2-inch and sew in place using a light-duty sewing machine, size E nylon thread, 7 to 11 stitches per inch. Stitch over edge; then backstitch 1/2-inch.

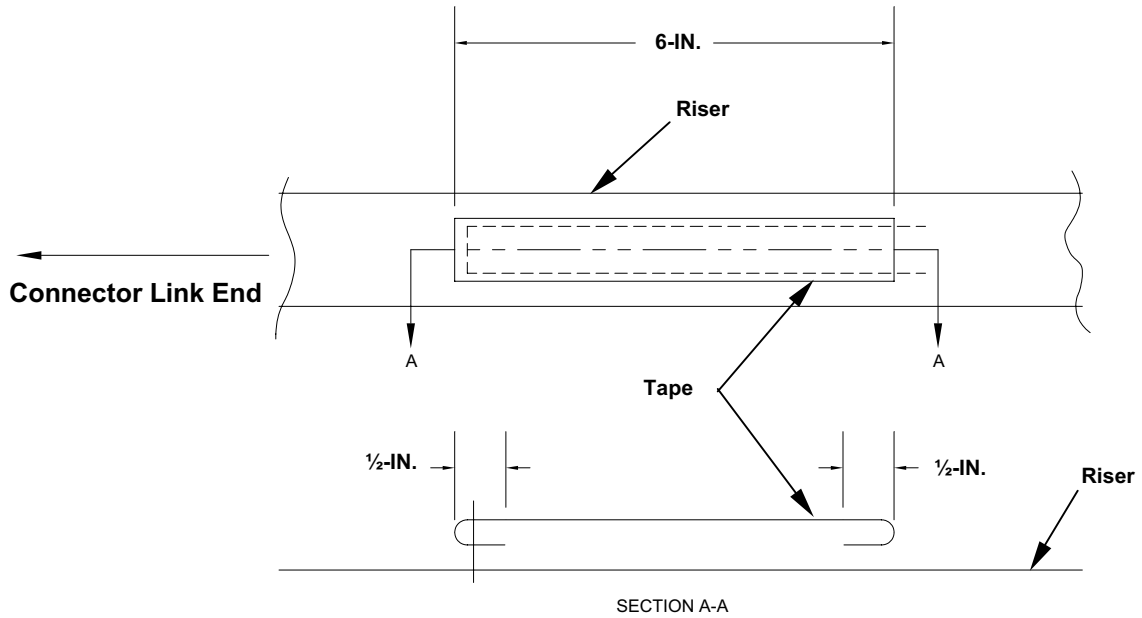

END OF WORK PACKAGE

---

**UNIT MAINTENANCE**  
**MC-4 RAM AIR FREE-FALL PERSONNEL PARACHUTE SYSTEM**  
**RISER HOOK AND PILE TAPES**

---

**THIS TASK COVERS:**

- Repair
  - Replace
- 

**INITIAL SETUP:****Tools**

Sewing Machine, Light-Duty (Table 1, WP 0015 00)  
Shears (Item 39, WP 0063 00)  
Stitch Removal Tool (Item 40, WP 0063 00)

**Personnel Required**

92R (10) Parachute  
Rigger

**Materials/Parts**

Fastener Tape, Hook, 1-IN. Wide, Type II, Class 1 (Item 15, WP 0076 00)  
Fastener Tape, Pile, 1-IN. Wide, Type II, Class 1 (Item 16, WP 0076 00)  
Fastener Tape, Pile, 2-IN. Wide, Type II, Class 1 (Item 17, WP 0076 00)  
Thread, Nylon, Size E (Item 43/44, WP 0076 00)

**Equipment Condition**

Lay out on packing  
table or other suitable  
area.

---

**REPAIR**

If loose or broken threads are present, restitch with size E nylon thread in accordance with WP 0015 00.

**REPLACE**

Replace damaged hook and pile tapes as follows:

---

**NOTE**

---

Damaged hook and pile tapes must be replaced in complete lengths.

1. Remove damaged tape by carefully removing stitching securing it to keeper.
2. Locate replacement tape directly over location where previously removed.
3. Sew in place with a light-duty sewing machine, size E nylon thread and 7 to 11 stitches per inch using original stitch pattern.

**END OF WORK PACKAGE**



---

**UNIT MAINTENANCE**  
**MC-4 RAM AIR FREE-FALL PERSONNEL PARACHUTE SYSTEM**  
**SUSPENSION LINE ATTACHING LOOP**

---

**THIS TASK COVERS:**

- Repair
- 

**INITIAL SETUP:****Tools**

Sewing Machine, Double Box-X (Table 1, WP 0015 00)  
Stitch Removal Tool (Item 40, WP 0063 00)

**Personnel Required**

92R (10) Parachute Rigger

**Materials/Parts**

Ink, Marking (Item 25/26, WP 0076 00)  
Thread, Nylon, Size E (Item 43/44, WP 0076 00)

**Equipment Condition**

Lay out on packing table or other suitable area.

---

**REPAIR**

1. If loose or broken threads are present, restitch with size E nylon thread in accordance with WP 0015 00.
2. The suspension line-attaching loop may need to be removed and reattached in order to repair a portion of the damaged canopy. Remove and reattach the suspension line attaching loop as follows:
  - a. Using an authorized marking aid of contrasting color, mark the original location of the suspension line-attaching loop using the adjoining loaded rib as a guide to determine where to reattach the suspension line-attaching loop.
  - b. Using the stitch removal tool, carefully remove the suspension line attachment loop from the canopy.
  - c. Repair canopy damage as outlined in the applicable WP.
  - d. Using a double box-X pattern sewing machine, size E nylon thread and 56 stitches per inch, reattach the suspension line-attaching loop over the original stitch pattern location previously marked.

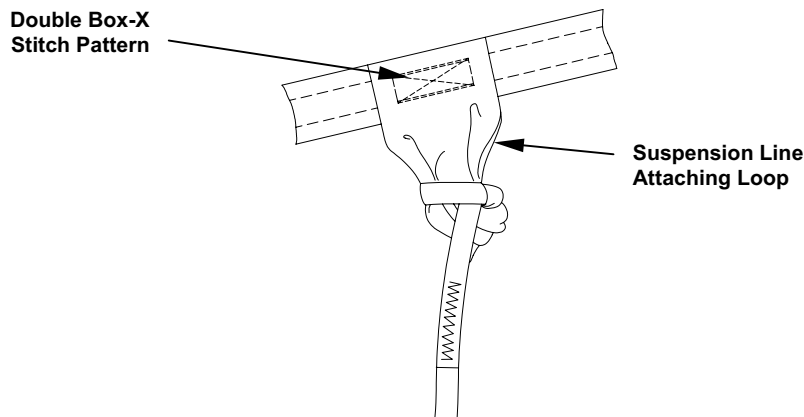

- e. Perform continuity check IAW WP 0005 00 or WP 0006 00

**END OF WORK PACKAGE**





---

**UNIT MAINTENANCE**  
**MC-4 RAM AIR FREE-FALL PERSONNEL PARACHUTE SYSTEM**  
**HARNES/CONTAINER**

---

**THIS TASK COVERS:**

- Repair
  - Replace
- 

**INITIAL SETUP:****Tools**

Bit, Drill,  $\frac{5}{8}$ -IN., Countersink (Item 3, WP 0063 00)  
 Drill, Electric,  $\frac{3}{8}$ -IN. Drive (Item 14, WP 0063 00)  
 Grommet Setting, Stainless Steel (Item 17/18, WP 0063 00)  
 Knife (Item 23, WP 0063 00)  
 Needle, Tacking (Item 29, WP 0063 00)  
 Sewing Machine, Darning (Table 1, WP 0015 00)  
 Sewing Machine, Double Needle (Table 1, WP 0015 00)  
 Sewing Machine, Light-Duty (Table 1, WP 0015 00)  
 Sewing Machine, Medium-Duty (Table 1, WP 0015 00)  
 Sewing Machine, Medium-Duty Zig-zag (Table 1, WP 0015 00)  
 Sewing Machine, Zig-zag (Table 1, WP 0015 00)  
 Shears (Item 39, WP 0063 00)  
 Stitch Removal Tool (Item 40, WP 0063 00)

**Equipment Condition**

Lay out on packing table or other suitable area. Canopy deployed.

**Personnel Required**

92R (10) Parachute Rigger

**Follow-Up Procedure**

Service upon receipt (WP 0004 00)

**Materials/Parts**

AAD Junction Plate (Item 15, WP 0071 00)  
 Cloth, Duck, Textured Nylon, CG (Item 7, WP 0076 00)  
 Fastener Tape, Hook, 1-IN. Wide (Item 15, WP 0076 00)  
 Fastener Tape, Pile, 1-IN. Wide (Item 16, WP 0076 00)  
 Flap Assembly Reserve (Item 26, WP 0071 00)  
 Stiffener, Left Flap (Item 18, WP 0071 00)  
 Stiffener, Main Bottom Flap (Item 13, WP 0071 00)  
 Stiffener, Main Top Flap (Item 14, WP 0071 00)  
 Stiffener, Main, Right Flap (Item 17, WP 0071 00)  
 Stiffener, Reserve (Item 25, WP 0071 00)  
 Tape, Lacing and Tying (Item 33, WP 0076 00)  
 Tape, Nylon (Binding),  $\frac{3}{4}$ -IN. (Item 37, WP 0076 00)  
 Thread, Nylon, Size E (Item 43/44, WP 0076 00)  
 Thread, Nylon, Size FF (Item 42, WP 0076 00)  
 Webbing, Elastic, 1-IN. (Item 47, WP 0076 00)  
 Webbing, Textile, Nylon, Type VII (Item 49, WP 0076 00)

---

**REPAIR**

Repair. Patching harness/container.

1. Small holes that are too large for darns can be patched using basic patching procedures as stated in WP 0015 00.
2. All patches are to be applied to the outside of the container.
3. Container fabric to be darned will be in areas of double nylon duck fabric. The damaged area may not exceed  $\frac{1}{2}$ -inch and stitching will extend  $\frac{1}{4}$ -inch beyond the damage. A maximum of two (2) darns per flap/panel, not closer than 4-inches to each other, is authorized. Accomplish machine darning IAW WP 0015 00 and the above limitations.

**REPLACE**

1. Replace unserviceable components of the harness/container as follows:
  - a. Remove unserviceable harness/container as follows:
    - (1) Open snap fastener on reserve static line shackle and remove static line from shackle.

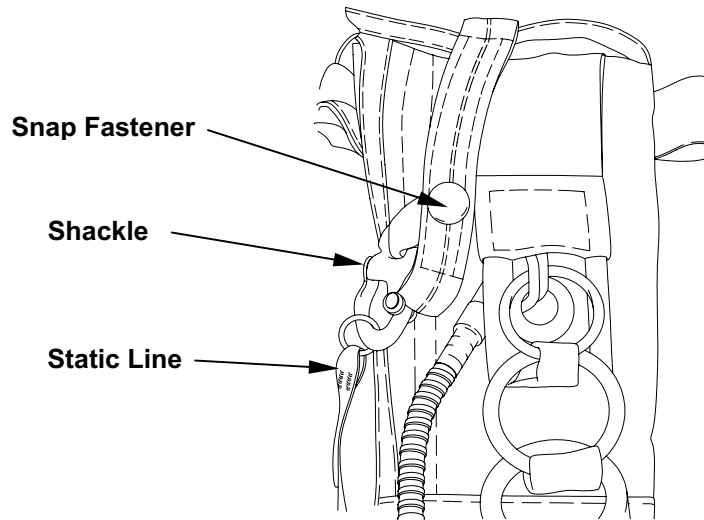

- (2) Pull main canopy release ripcord. This allows the two rings on the risers to disengage from base ring, completing removal of main risers.

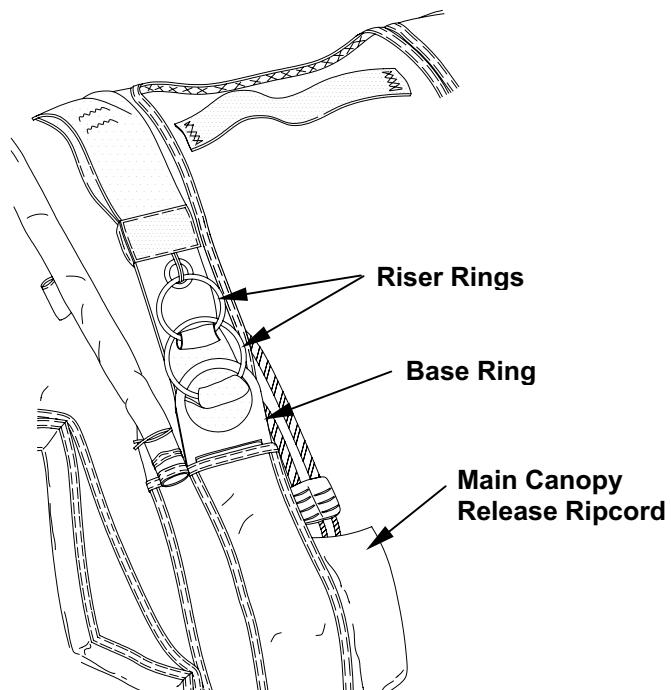

- (3) On reserve risers, remove control lines from toggle rings by untying overhand knots.

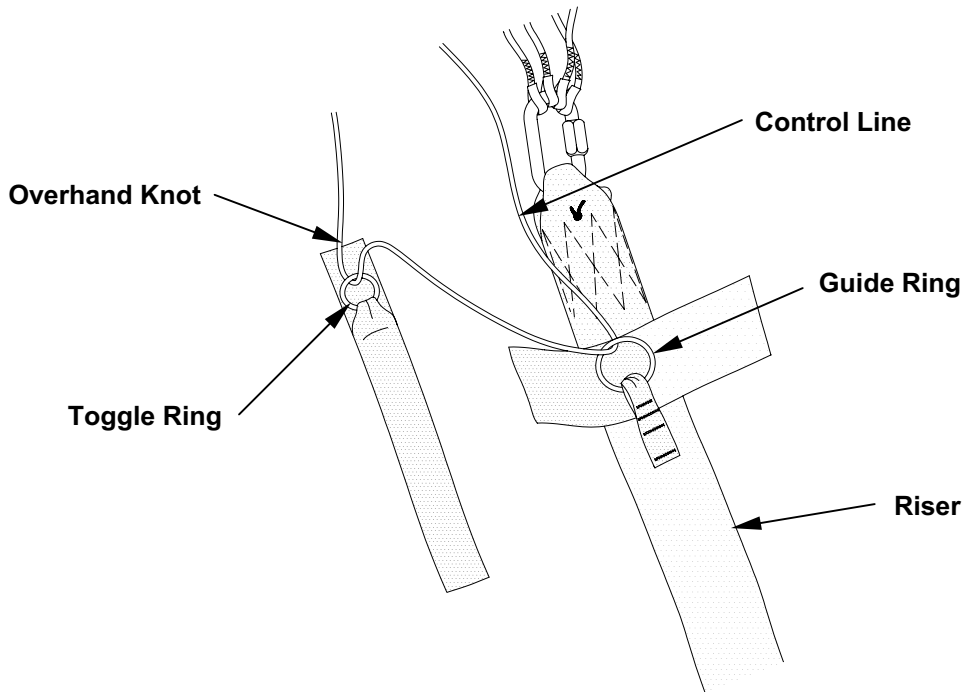

- (4) Pull control lines through guide rings on rear risers.
- (5) Cut and remove tacking from risers.

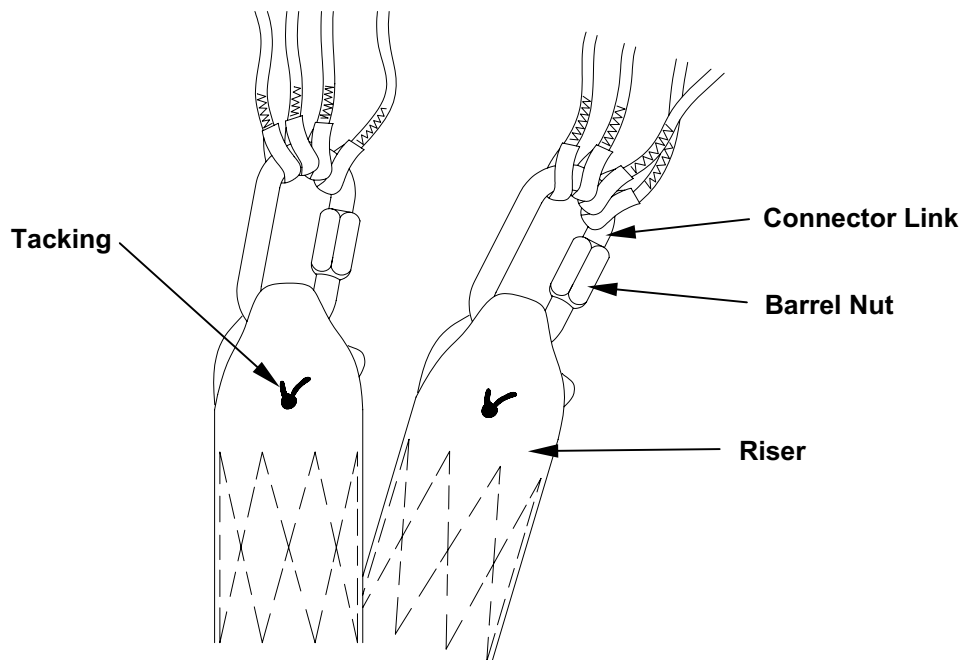

- (6) Using a  $\frac{7}{16}$ -inch open-end wrench, loosen barrel nuts on connector links.
  - (7) Remove connector links from risers.
  - (8) Reattach a serviceable harness/container IAW WP 0005 00 and WP 0006 00.
- b. Main Parachute Compartment. Replace top flap, bottom flap, left flap and right flap pack stiffeners as follows:
- (1) Replace the top flap pack stiffener as follows:
    - (a) Cut stitching and remove plastic pack stiffener from container.
    - (b) Obtain a new pack stiffener from supply stock.
    - (c) Reattach the new pack stiffener to the container using a medium-duty zigzag sewing machine, size FF thread, and 7 to 11 stitches per inch.
  - (2) Replace bottom and left flap pack stiffeners as follows:
    - (a) Remove the No. 0 grommet IAW WP 0038 00.
    - (b) Cut the single row of straight stitching on the inside of the container exposing the plastic pack stiffener.
    - (c) Remove broken stiffener.
    - (d) Obtain a new stiffener from supply stock.
    - (e) Replace the grommet IAW WP 0038 00.

**NOTE**

Ensure the pre-cut hole for the grommet is large enough to accommodate a new grommet. If not, enlarge the hole using a  $\frac{5}{8}$ -inch countersink drill and  $\frac{5}{8}$ -inch drill bit as required.

- (f) Replace stiffener and set a new grommet ensuring the grommet is rolled over washer and the washer is on the inside of the container.
  - (g) Using a medium-duty sewing machine, size E nylon thread and 7 to 11 stitches per inch, replace the single row of straight stitching removed in step (b), above.
- (3) Replace right flap pack stiffener as follows:
    - (a) Remove lacing tape on base plate.
    - (b) Remove the No. 2 grommet.
    - (c) Cut the single row of straight stitching on the inside of the container exposing the clear plastic.
    - (d) Remove broken plastic stiffener.

- (e) Obtain a new stiffener from supply stock.

NOTE

Ensure the pre-cut hole for the grommet is large enough to accommodate a new grommet. If not, enlarge the hole using a  $\frac{5}{8}$ -inch countersink drill and  $\frac{5}{8}$ -inch drill bit as required.

- (f) Replace stiffener and re-sew straight stitches removed in step (c) above, using a medium-duty sewing machine, size E nylon thread and 7 to 11 stitches per inch.
  - (g) Replace AAD Junction plate grommet and washer. Set the grommet ensuring the grommet is rolled over washer and that the washer is to the inside of the container.
  - (h) Align the AAD Junction plate with the tacking holes on the container.
  - (i) Hand tack AAD Junction plate to the container using procedures outlined in WP 0045 00.
- c. Reserve Parachute Compartment. Replace top flap, bottom flap, left flap and right flap pack stiffeners as follows:
- (1) Replace the top flap pack stiffener as follows:
    - (a) Remove approximately 2-inches of stitching that secures the hook and pile fastener tape on each side of the container.
    - (b) Carefully cut and remove only the upper tacking securing the reserve ripcord housing to the container.
    - (c) Carefully cut and remove the tacking securing the main canopy release ripcord housings.
    - (d) Remove the short housing and set aside, remove only the  $\frac{3}{4}$ -inch keepers and set aside.
    - (e) Cut stitching and remove the ripcord protector flap.
    - (f) Carefully cut stitching on the  $\frac{3}{4}$ -inch binding tape, which secures the pack stiffener to the container.
    - (g) Remove plastic stiffener from container.
    - (h) Using a medium-duty sewing machine, size E nylon thread and 7 to 11 stitches per inch, re-sew the main cable-housing keeper to the center of the container with one row of stitching.
    - (i) Obtain a new stiffener from supply stock.
    - (j) Using a medium-duty sewing machine, size E nylon thread and 7 to 11 stitches per inch, re-sew the new stiffener to the top of the container.
    - (k) Remove all excess thread from the  $\frac{3}{4}$ -inch binding tape and re-sew the tape back into place using a medium-duty sewing machine, size E nylon thread and 7 to 11 stitches per inch.

- (l) If the binding tape was damaged during removal, replace the damaged area as required using a double needle sewing machine with  $\frac{3}{4}$ -inch binding attachment, size E nylon thread and 7 to 11 stitches per inch.
  - (m) Using a medium-duty zig-zag sewing machine, size E nylon thread and 7 to 11 stitches per inch, reattach the protector flap to the container in accordance with the original stitch formation.
  - (n) Using a medium-duty sewing machine, size E nylon thread and 7 to 11 stitches per inch, re-sew the hook and pile fastener tape removed in step (a) above.
  - (o) Reroute the long and short housings and tack back into place using procedures outlined in WP 0042 00.
  - (p) Re-tack reserve ripcord housing IAW WP 0043 00.
- d. Replacing Ripcord Protector Flap. Replace the ripcord protector flap as follows:
- (1) Remove approximately 2-inches of stitching that secures the hook and pile fastener tape on each side of the container.
  - (2) Carefully cut and remove only the upper tacking securing the reserve ripcord housing to the container.
  - (3) Carefully cut and remove the tacking securing the main canopy release ripcord housings.
  - (4) Remove the short housing and set aside, remove only the  $\frac{3}{4}$ -inch keepers and set aside.
  - (5) Cut stitching and remove the ripcord protector flap.
  - (6) Obtain a new protector flap from supply stock.
  - (7) Using a medium-duty zig-zag sewing machine, size E nylon thread and 7 to 11 stitches per inch, reattach the protector flap to the container in accordance with the original and stitch formation.
  - (8) Using a medium-duty sewing machine, size E nylon thread and 7 to 11 stitches per inch, re-sew the hook and pile fastener tape removed in step (1) above.
  - (9) Reroute the long and short housings and tack back into place using procedures outlined in WP 0042 00.
  - (10) Re-tack reserve ripcord housing IAW WP 0043 00.

- e. Replace Waistband. Replace waistband as follows:
- (1) Carefully cut the stitching at the bottom of the container securing the back pad to the container exposing the waistband.
  - (2) Carefully cut the zig-zag stitching securing the back straps to the container.
  - (3) Carefully cut the zig-zag stitching on the left flap, which secures the waistband end adjuster.
  - (4) Carefully cut the boxed stitch formation, which secures the waistband to the container.
  - (5) Remove the type VIII nylon from the friction adapter located on the FF-2 pocket flap and remove the waistband.
  - (6) Obtain an appropriate length of type VII nylon webbing from supply stock.
  - (7) Using the old waistband, mark the new waistband where it is to be sewn to the container.
  - (8) Using a medium-duty sewing machine, size E nylon thread and 7 to 11 stitches per inch, sew the box stitch formation securing the waistband to the container.
  - (9) Using a medium-duty zig-zag sewing machine, size FF nylon thread and 7 to 11 stitches per inch, sew the back straps back into place.
  - (10) Using a medium-duty zig-zag sewing machine, size FF nylon thread and 7 to 11 stitches per inch, secure the waistband end adjuster to the left flap.
  - (11) Replace the type VIII nylon removed in item (5) above.
  - (12) Using a medium-duty sewing machine, size E nylon thread and 7 to 11 stitches per inch, re-sew the back pad to the container.
  - (13) Using a medium-duty zig-zag sewing machine, size E nylon thread and 7 to 11 stitches per inch, re-sew the zig-zag stitching on both sides of each back strap.
- f. Replace Slack Retainer. Replace slack retainer as follows:

NOTE

If the waistband extension (02 pocket) slack retainer is unserviceable, the use of a retainer band may be used to secure the waistband extension temporarily in lieu of the 02 slack retainer until such time as the slack retainer can be replaced.

- (1) Carefully cut and remove damaged slack retainer.
  - (2) Cut a 2 ½-inch length of 1-inch elastic webbing. Using a searing device, sear running ends of tape.
  - (3) Using a double needle sewing machine with a binding attachment, size E nylon thread and 7 to 11 stitches per inch, bind the raw edge of the elastic webbing with ¾-inch binding tape.
  - (4) Using a medium-duty zig-zag sewing machine, size E nylon thread and 7 to 11 stitches per inch, sew the new slack retainer to the flap of the container as close to the original position, construction and stitch formation as possible.
- g. Harness/Container Hook and Pile Tapes. Repair/replace harness/container hook and pile tapes as follows:
- (1) Repair. If loose or broken threads are present, restitch with size E nylon thread in accordance with WP 0015 00.
  - (2) Replacement. Replace damaged hook and pile tapes as follows:

NOTE

Damaged hook and pile tapes must be replaced in complete lengths.

- (a) Remove damaged tape by carefully removing stitching securing it to container.
  - (b) Locate replacement tape directly over location where previously removed.
  - (c) Sew in place with light-duty sewing machine, size E nylon thread and 7 to 11 stitches per inch using original stitch pattern.
- h. Hook and Pile Tape on Ripcord Protector Flap. Replace hook and pile tape on ripcord protector flap as follows:

NOTE

Stitching will be visible on the flap after the hook and pile tape is replaced on the pack stiffener.

- (1) Remove unserviceable hook and pile tape as required.
  - (2) Replace hook and pile tape as required and sew using a medium-duty sewing machine, size E nylon thread and 7 to 11 stitches per inch.
- i. Hook and Pile Tape on the Pack Stiffener. Replace hook and pile tape on the pack stiffener as follows:
- (1) Remove unserviceable hook and pile tape as required.



- (2) Replace hook and pile tape as required and sew using a medium-duty sewing machine, size E nylon thread, and 7 to 11 stitches per inch.

j. AR2 Power Cable Sleeve. Replace AR2 Power Cable Sleeve as follows:

- (1) Cut a 18 inch length of Tape, Nylon, Type III, OD, 3/4-inch wide binding tape. ■
- (2) Cut and sear an 16 1/2-inch x 3-inch piece of green, textured nylon duck cloth. ■

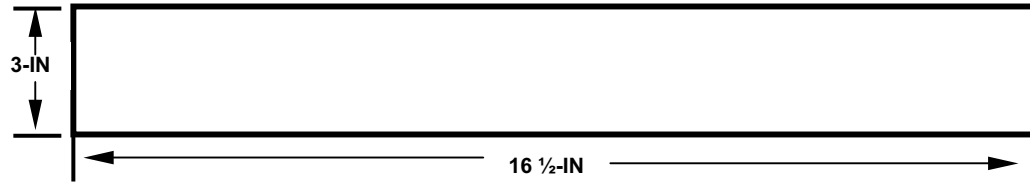

- (3) On the 3-inch length, fold ends under 1/2-inch and sew with a light-duty sewing machine, type 301, and size E nylon thread, 7 to 11 stitches per inch. Backstitch not less than 1/2-inch.

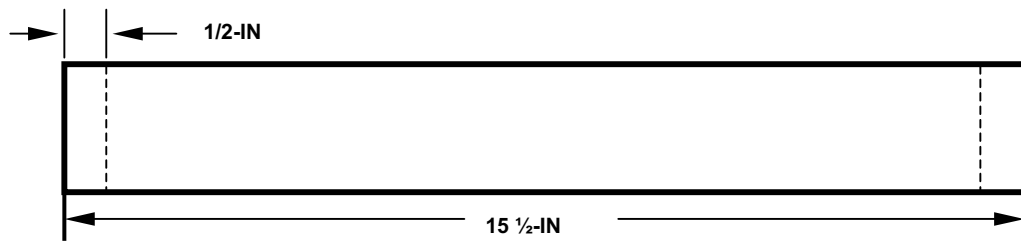

- (4) With raw edges inside, fold in half, lengthwise. Join folded fabric together using 3/4-inch green nylon binding tape. Equal the excess length of binding tape on both ends of the sleeve. Sew one (1) row with a light-duty sewing machine, type 301, and size E nylon thread, 7 to 11 stitches per inch. Backstitch not less than 1/2-inch.

- (5) Pre-mark sleeve on both sides of binding tape. Starting from one end, measure 1-inch, 7 1/2-inches and 8 1/2-inches. From the other end, measure 1-inch.

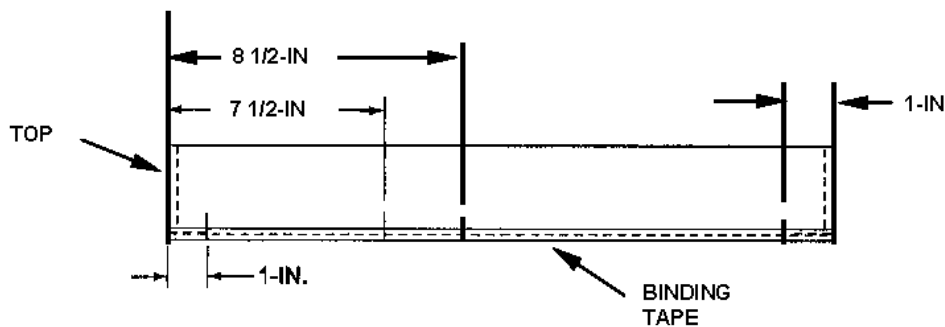

---

**NOTE**

---

Prior to installing the AR2 power cable sleeve, the main and reserve parachutes must be completely unpacked.

- (6) Position harness/container assembly on work surface with pack tray facing down and AR2 padded pocket at the bottom right.
- (7) Stitch AR2 power cable sleeve to harness/container assembly seam that secures the reserve compartment side panel and top to back panel as follows:

---

**NOTE**

---

Ensure reserve container flap is clear of sewing area.

- (8) Measure and mark 2-inches from center of the power cable opening located at the top of the harness/container assembly between the risers.
- (9) Align the TOP end of the AR2 power cable sleeve end with the harness/container assembly's 2-inch mark.
- (10) Fold under the excess binding tape and stitch AR2 power cable sleeve to the container with three (3) continuous rows of backstitching from the end of the sleeve to the 1-inch mark with a medium-duty sewing machine, type 301, and size FF thread, 6 to 9 stitches per inch.
- (11) The portion of the sleeve (approximately 6 ½-inches) to the 7 ½-inch location mark, as identified in the illustration below, is not attached to the container.
- (12) Align the 7 ½-inch location mark on the AR2 power cable sleeve with the top of the harness/container assembly weapon tie down loop.
- (13) At this location, stitch remainder of AR2 power cable sleeve to harness/container assembly with three (3) continuous rows of backstitching for 1-inch.
- (14) Fold under excess binding tape. Sew remainder of the sleeve (approximately 8 inches) to the container and finish with a total of three (3) continuous rows of 1-inch backstitching.

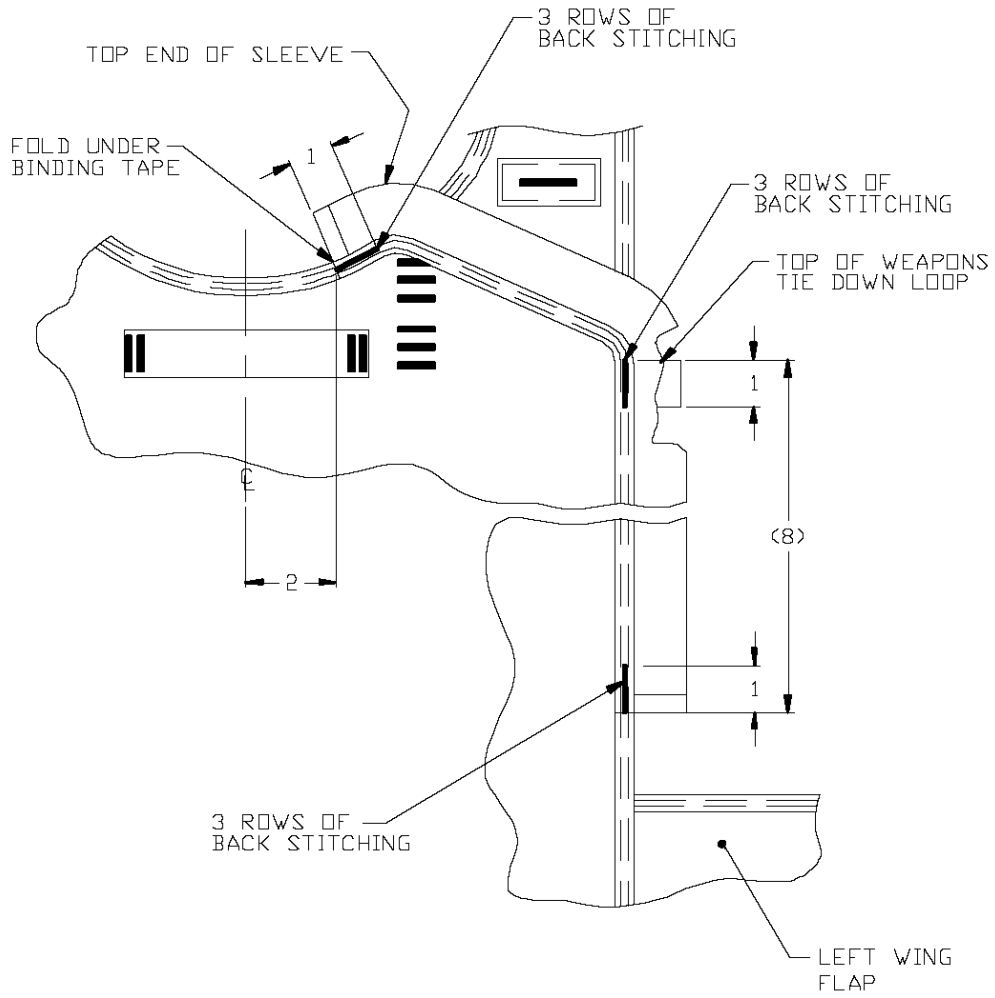

**END OF WORK PACKAGE**



---

**UNIT MAINTENANCE**  
**MC-4 RAM AIR FREE-FALL PERSONNEL PARACHUTE SYSTEM**  
**GROMMETS**

---

**THIS TASK COVERS:**

- Repair
  - Replace
- 

**INITIAL SETUP:****Tools**

Die Sets, Spur Grommet, Size 0 (Items 17, WP 0063 00)  
Die Sets, Spur Grommet, Size 2 (Items 18, WP 0063 00)  
Die Sets, Spur Grommet, Size 5 (Items 12, WP 0063 00)  
File, Flat, 1-IN. (Item 15, WP 0063 00)  
Knife, Hot, Metal (Item 24, WP 0063 00)  
Mallet, Rawhide (Item 27, WP 0063 00)  
Pliers, Large, Diagonal Cut (Item 32, WP 0063 00)  
Sewing Machine, Medium-Duty (Table 1, WP 0015 00)  
Shears (Item 39, WP 0063 00)

**Personnel Required**

92R (10) Parachute Rigger

**Equipment Condition**

Lay out on packing table or other suitable area.

**Materials/Parts**

Cloth, Abrasive (Item 6, WP 0076 00)  
Grommets, Rolled Rim, Spur Washer, No. 0, 305 Stainless Steel (Items 23, WP 0076 00)  
Grommets, Rolled Rim, Spur Washer, No. 2, 305 Stainless Steel (Items 24, WP 0076 00)  
Grommets, Rolled Rim, Spur Washer, No. 5, Type III, Class 2 (Items 22, WP 0076 00)  
Thread, Nylon, Size E (Item 43/44, WP 0076 00)  
Webbing, Nylon, Type II (Item 48, WP 0076 00)

---

**REPAIR**

Repair grommets as follows:

1. Remove burrs, rough spots, rust, or corrosion from an installed grommet by filing with a file or by buffing with an abrasive cloth.
2. Reseat a loose grommet using procedures listed in the REPLACE procedures detailed below.
3. If fabric area around original grommet has been damaged, repair area by applying a reinforcement patch to outside of flap. Use a 1-inch square of seared type II nylon webbing.

---

**NOTE**

---

Reinforcement is allowed only on the bottom, left, and right closing flaps of the reserve parachute container.

**REPLACE**

Replace grommets as follows:

1. Remove original grommet as follows:
  - a. Using suitable type tool, lift edge of original washer at one point.
  - b. Grip lifted washer edge with diagonal cutters and roll washer edge back to lift washer from original grommet. Remove original grommet from material.

2. Insert barrel of replacement grommet through accommodating hole in material and ensure grommet flange is located on same side of material as original grommet.
3. Position the grommet on the die with barrel facing up and place washer over grommet barrel. Ensure grommet barrel and washer are aligned to prevent off-center setting of grommet.
4. Using a punch and rawhide mallet or other non-steel impact device, spread grommet barrel by hammering until barrel collar is rolled down smooth on washer. If grommet barrel splits during hammering, remove and replace installed grommet with a serviceable item from stock. Repeat the procedure in steps 2. and 3., above.

**END OF WORK PACKAGE**

---

**UNIT MAINTENANCE**  
**MC-4 RAM AIR FREE-FALL PERSONNEL PARACHUTE SYSTEM**  
**SNAP FASTENERS**

---

**THIS TASK COVERS:**

- Repair
  - Replace
- 

**INITIAL SETUP:****Tools**

Anvil, Chuck Fastener (Item 1, WP 0063 00)  
Chuck (Items 6/7, WP 0063 00)  
Die (Items 8/9, WP 0063 00)  
Holder, Die Fastener (Item 20, WP 0063 00)  
Key, Socket Head Set (Item 22, WP 0063 00)  
Knife, Hot Metal (Item 24, WP 0063 00)  
Mallet, Rawhide (Item 27, WP 0063 00)  
Pliers, Large, Diagonal Cut (Item 32, WP 0063 00)  
Sewing Machine, Medium-Duty (Table 1, WP 0015 00)  
Shears (Item 39, WP 0063 00)

**Equipment Condition**

Lay out on packing table or other suitable area.

**Personnel Required**

92R (10) Parachute Rigger

**Materials/Parts**

Fastener, Snap, Button (Item 18, WP 0076 00)  
Fastener, Snap, Eyelet (Item 19, WP 0076 00)  
Fastener, Snap, Socket (Item 20, WP 0076 00)  
Fastener, Snap, Stud (Item 21, WP 0076 00)  
Thread, Nylon, Size E (Item 43/44, WP 0076 00)  
Webbing, Nylon, Type II (Item 48, WP 0076 00)

---

**REPAIR**

Snap fastener repair is limited to reseating which will be accomplished using the applicable procedures and tools prescribed in the replace procedures detailed below.

**REPLACE**

A snap fastener that is defective or cannot be reseated will be replaced with a serviceable item from stock. However, if only one part of a fastener is defective, such as the socket or stud, just that particular portion of the fastener assembly requires replacement. Replace a damaged snap fastener as follows:

1. Original snap fastener removal.
  - a. Cut crimped edge of applicable snap fastener assembly part at three or four points with diagonal cutters.
  - b. Using a suitable type tool, pry back fastener crimped edges and remove applicable defective fastener parts.

---

**NOTE**

---

Reinforcement is not authorized on the inner top main container closing flap or in the area of the left riser static line snap fastener.

2. Reinforcement of original snap fastener area. If fabric area around original snap fastener is damaged, repair area by applying a reinforcement patch to the outside of the material. Use a 1-inch square of seared type II nylon webbing.

3. Hand-held method. Proceed as follows:

- a. Place selected chuck in open end of holder and secure chuck in place using locking screw located on one side of holder. Then place the die into anvil.

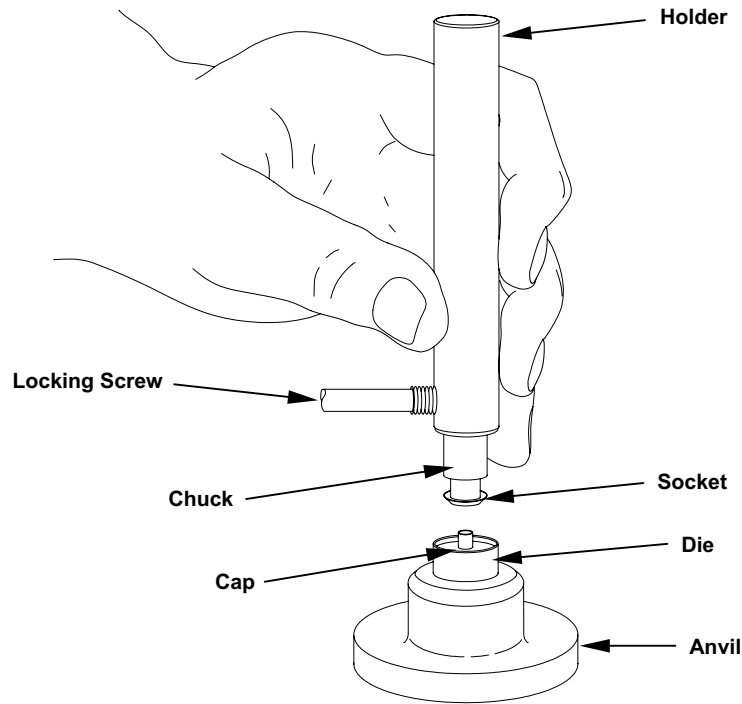

**NOTE**

In most instances, a chuck will be installed in the hand held holder and a die will be placed in the anvil. However, there may be some occasions that require the location of the chuck and die to be reversed. This situation may also apply to the hand or foot operated press.

- b. Fit socket or stud, as applicable, on chuck lower end. Place cap or post, as applicable, on die with barrel facing up.
- c. Position material over barrel of cap or post. Ensure that fastener socket or stud is located on proper side of material for subsequent fastener engagement.
- d. Place socket or stud on barrel of cap or post. With a mallet, strike holder, clinching the two snap fastener components to material.
- e. Remove clinched snap fastener components from chuck and die set and check seating of joined components. If applicable components are not properly seated, repeat procedures in step d., above.



- f. Check engagement of installed snap fastener components with opposite mating components to ensure open and closed snapping process without hindrance. If snap engaging process cannot be accomplished without difficulty, replace opposite mating snap fastener components using procedures in steps a. through e., above. As required, remove chuck and die from applicable snap fastener tools by reversing procedures in step 1., above.
4. Hand or foot operated press method. Installation of a snap fastener assembly by hand or foot operated press may be accomplished using the procedures in step 3., above, except one uses the hand or foot to press the two pieces together, and the chuck and die will be secured within the applicable press assembly using the available locking screws.

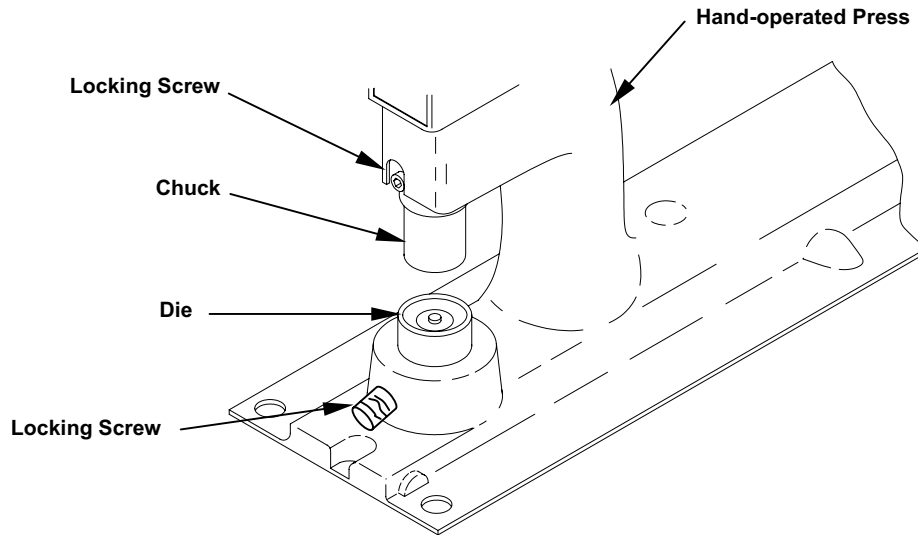

**END OF WORK PACKAGE**



**UNIT MAINTENANCE**  
**MC-4 RAM AIR FREE-FALL PERSONNEL PARACHUTE SYSTEM**  
**MAIN RIPCORD POCKET**

**THIS TASK COVERS:**

- Repair
- Replace

**INITIAL SETUP:**

**Tools**

- Sewing Machine, Bartack (Table 1, WP 0015 00)
- Sewing Machine, Light-Duty (Table 1, WP 0015 00)
- Sewing Machine, Zig-Zag (Table 1, WP 0015 00)
- Shears (Item 39, WP 0063 00)
- Stitch Removal Tool (Item 40, WP 0063 00)

**Personnel Required**

92R (10) Parachute Rigger

**Equipment Condition**

Lay out on packing table or other suitable area. Main ripcord and main canopy release ripcord removed.

**Materials/Parts**

- Pocket, Main Ripcord (Item 23, WP 0071 00)
- Thread, Nylon, Size E (Item 43/44, WP 0076 00)

**Follow-Up Procedure**

Ripcord Pin Pull-Force Check (WP 0014 00).

**REPAIR**

Main ripcord pocket repair is limited to restitching. Restitch over original stitch pattern using size E nylon thread, and 7 to 11 stitches per inch.

**REPLACE**

Replace an unserviceable main ripcord pocket as follows:

1. Carefully remove stitching (straight and zig-zag) attaching main ripcord pocket to container. Remove unserviceable pocket.

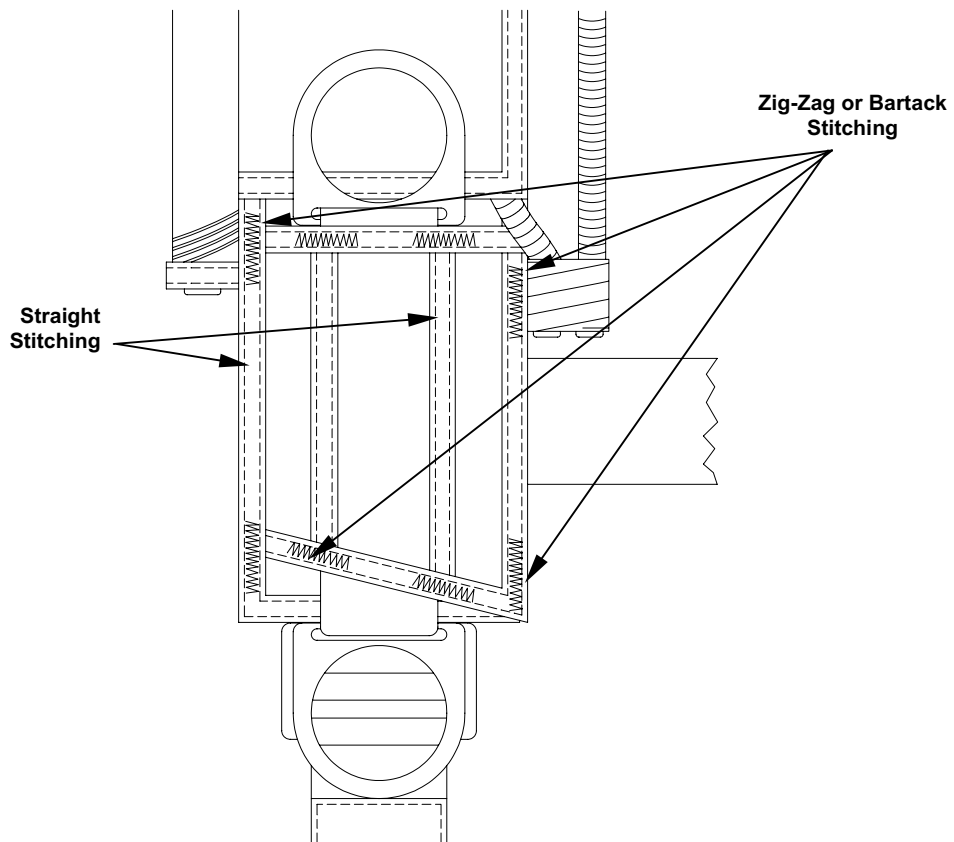

2. Place replacement ripcord pocket in position on container directly over position of removed pocket. Pocket is installed under tape on outside edge of container.
3. Using a light-duty sewing machine and size E nylon thread, sew in place on inside and outside edges of container using two (2) rows of stitching, 7 to 11 stitches per inch.
4. Reinforce the four (4) corners with either a zig-zag or bartack sewing machine (type 308 stitching), size E nylon thread, 8 to 12 stitches per inch.
5. Perform follow-up procedure (WP 0014 00).

**END OF WORK PACKAGE**

---

**UNIT MAINTENANCE**  
**MC-4 RAM AIR FREE-FALL PERSONNEL PARACHUTE SYSTEM**  
**RESERVE RIPCORD POCKET**

---

**THIS TASK COVERS:**

- Repair
  - Replace
- 

**INITIAL SETUP:****Tools**

Sewing Machine, Bartack (Table 1, WP 0015 00)  
 Sewing Machine, Light-Duty (Table 1, WP 0015 00)  
 Sewing Machine, Zig-Zag (Table 1, WP 0015 00)  
 Shears (Item 39, WP 0063 00)  
 Stitch Removal Tool (Item 40, WP 0063 00)

**Personnel Required**

92R (10) Parachute Rigger

**Equipment Condition**

Lay out on packing table or other suitable area.  
 Reserve ripcord removed.

**Materials/Parts**

Pocket, Reserve Ripcord (Item 21, WP 0071 00)  
 Thread, Nylon, Size E (Item 43/44, WP 0076 00)

**Follow-Up Procedure**

Ripcord Pin Pull-Force Check (WP 0013 00).

---

**REPAIR**

Reserve ripcord pocket repair is limited to restitching. Restitch over original stitch pattern using nylon thread, size E, 7 to 11 stitches per inch.

**REPLACE**

Replace an unserviceable reserve ripcord pocket as follows:

1. Carefully remove stitching (straight and zig-zag) attaching reserve ripcord pocket to container. Remove unserviceable pocket.

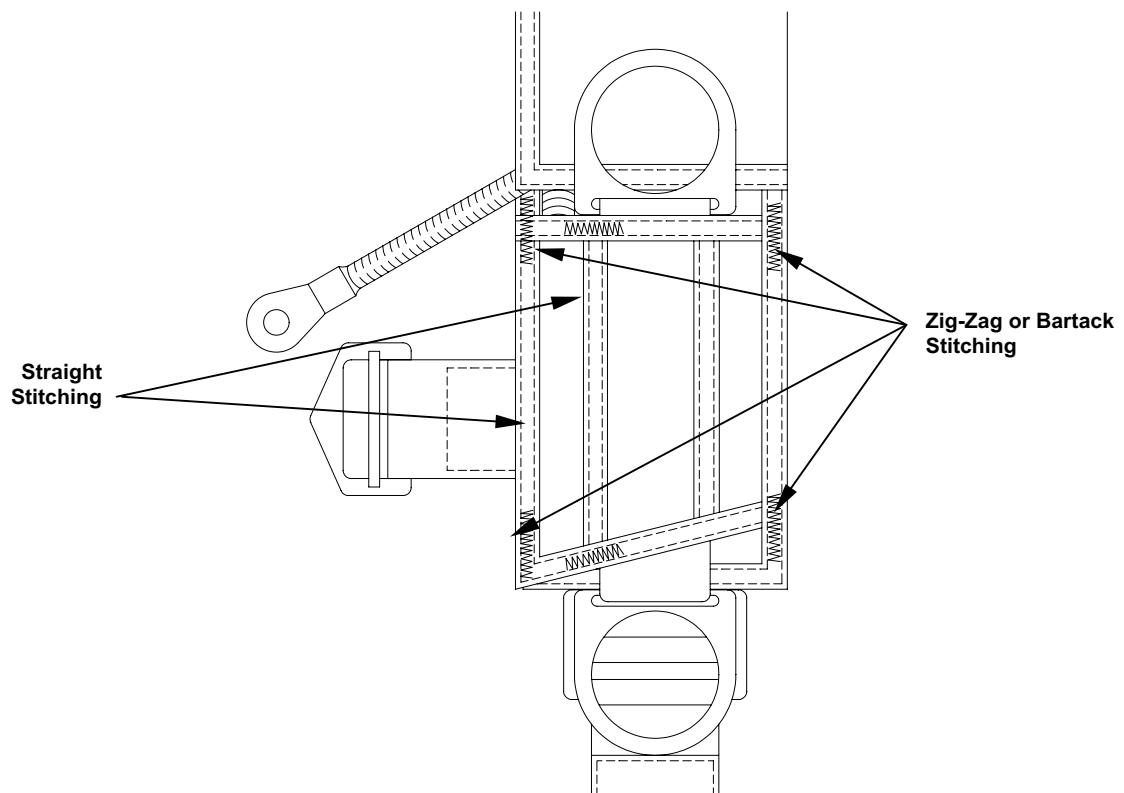

2. Place replacement ripcord pocket in position on container directly over position of removed pocket. Pocket is installed under tape on outside edge of container.
3. Using a light-duty sewing machine and size E nylon thread, sew in place on inside and outside edges of container using two rows of stitching, 7 to 11 stitches per inch.
4. Reinforce the four corners with either a zig-zag or bartack sewing machine (type 308 stitching), size E nylon thread, 8 to 12 stitches per inch.
5. Perform follow-up procedure (WP 0013 00).

**END OF WORK PACKAGE**

---

**UNIT MAINTENANCE**  
**MC-4 RAM AIR FREE-FALL PERSONNEL PARACHUTE SYSTEM**  
**MAIN CANOPY RELEASE RIPCORD AND HOUSING**

---

**THIS TASK COVERS:**

- Replace
- 

**INITIAL SETUP:****Tools**

Needle, Tacking (Item 29, WP 0063 00)  
Shears (Item 39, WP 0063 00)  
Tape Measure (Item 42, WP 0063 00)

**Materials/Parts**

Housing, Main Release, Long (Item 20 WP 0071 00)  
Housing, Main Release, Short (Item 24, WP 0071 00)  
Tape, Lacing and Tying (Item 33, WP 0076 00)

**Personnel Required**

92R (10) Parachute Rigger

**Equipment Condition**

Lay out on packing table or other suitable area.

---

**REPLACE**

1. Pull main release ripcord from its keeper and remove ripcord from housings.

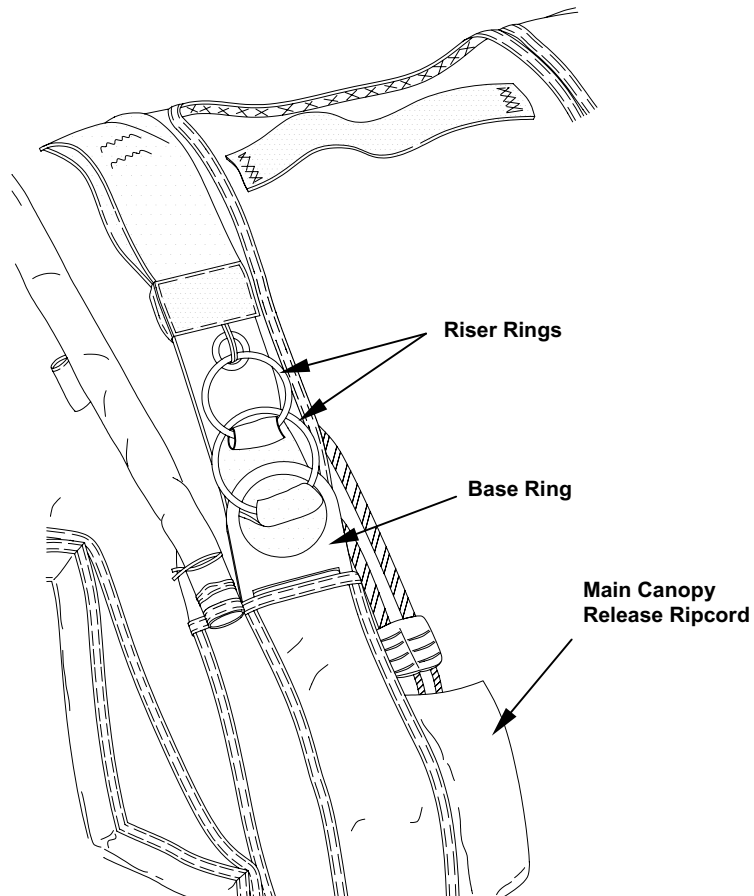

2. Carefully cut and remove tacking securing housings in harness keeper.
3. Remove short housing from keeper.

4. Open hook and pile tapes to expose long housing.
5. Carefully cut and remove tacking securing long housing to upper harness diagonal.
6. Pull long housing through keepers and remove from harness.

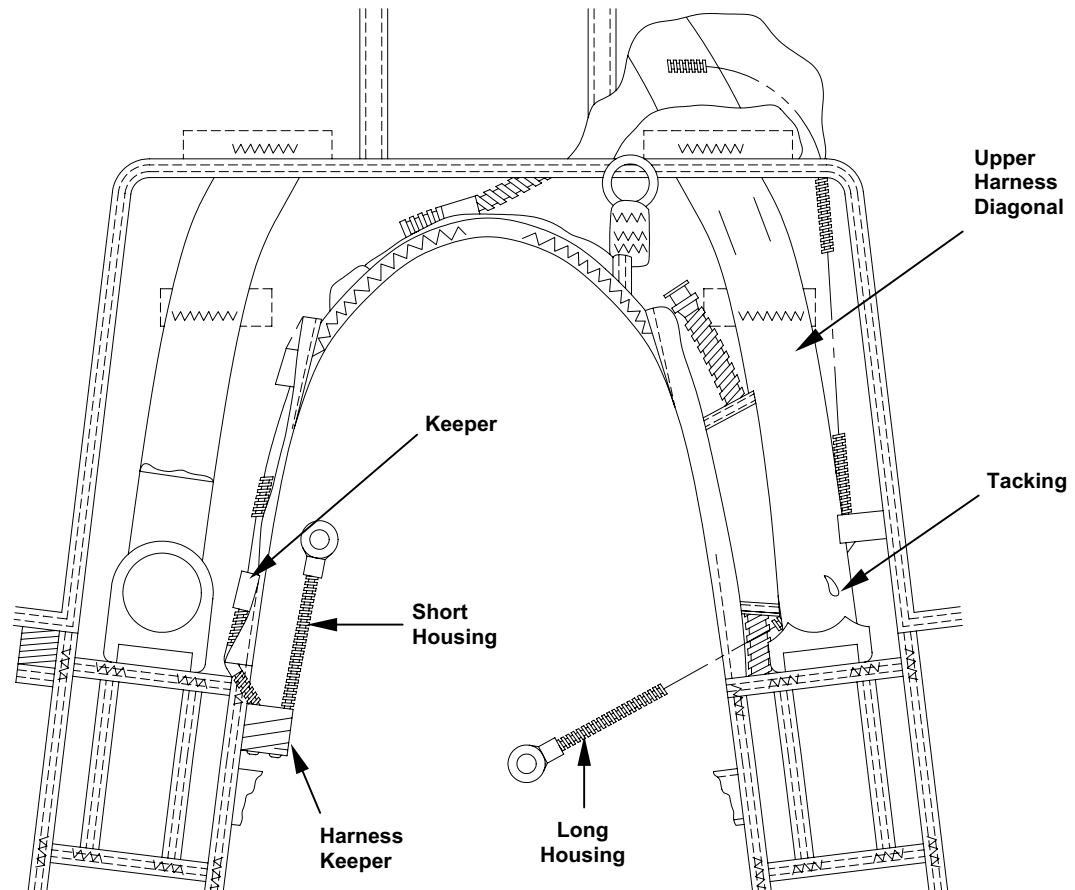

7. Route replacement long housing through four harness keepers and behind attachment point of upper harness diagonal and container.
8. Position housing so that 5 ¼-inches exists between center of terminal fitting and inside edge of upper harness diagonal.
9. Tack housing in position from underside of upper harness diagonal strap. Use two (2) turns of nylon tape, lacing and tying, doubled. Secure with a surgeon's knot and locking knot. Trim free ends ¾-inch from knot.



10. Position replacement short housing and opposite end of long housing in keeper next to main ripcord pocket. Tack housings in place from rear of keeper. Use tape, lacing and tying, doubled. Make one turn around short housing, three turns around both housings, then one turn around long housing. Secure with surgeon's knot and locking knot. Trim free ends  $\frac{3}{4}$ -inch from knot.

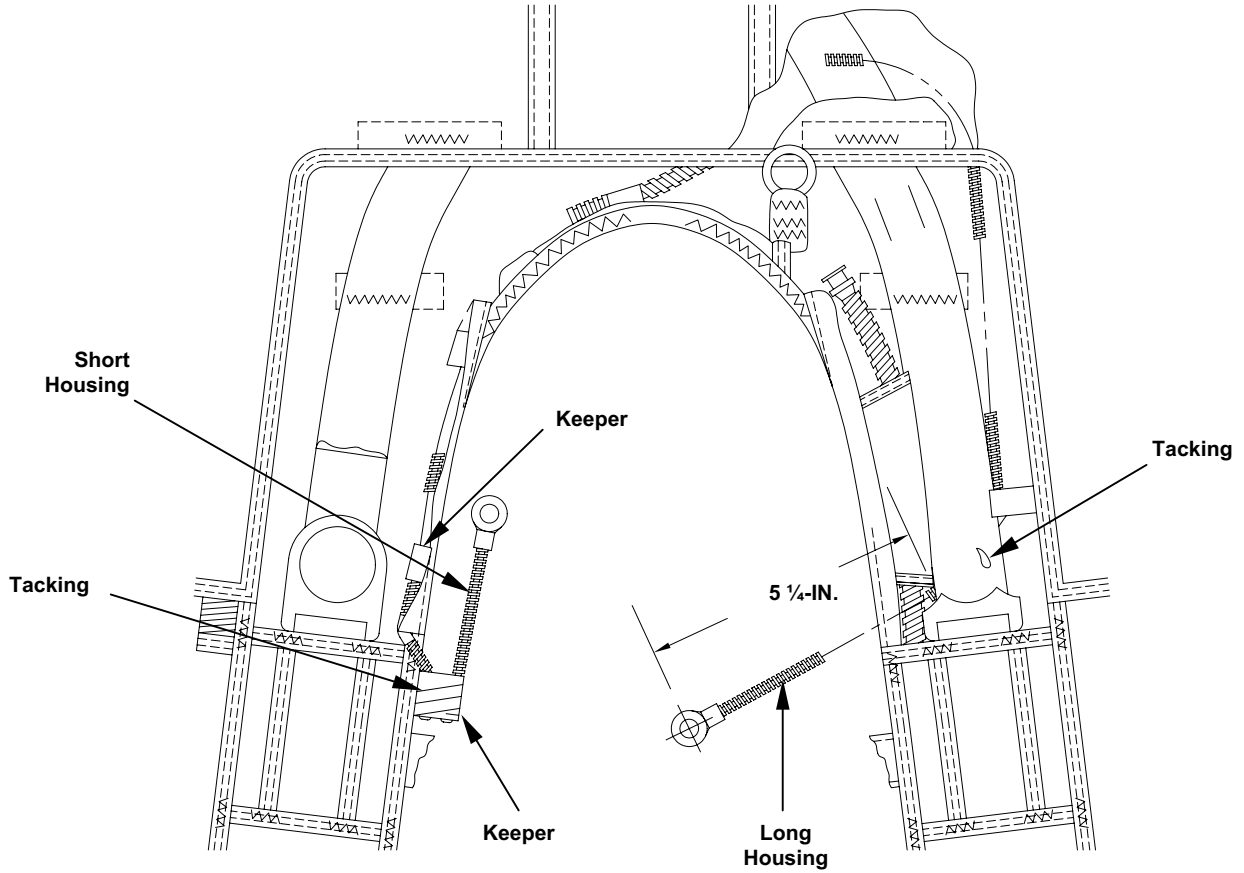

**END OF WORK PACKAGE**



---

**UNIT MAINTENANCE**  
**MC-4 RAM AIR FREE-FALL PERSONNEL PARACHUTE SYSTEM**  
**RESERVE RIPCORD HOUSING**

---

**THIS TASK COVERS:**

- Replace
- 

**INITIAL SETUP:****Tools**

Needle, Tacking (Item 29, WP 0063 00)  
Shears (Item 39, WP 0063 00)  
Tape Measure (Item 42, WP 0063 00)

**Materials/Parts**

Housing, Ripcord, Reserve, 11-IN. (Item 19, WP 0071 00)  
Tape, Lacing and Tying (Item 33, WP 0076 00)

---

**Personnel Required**

92R (10) Parachute Rigger

**Equipment Condition**

Lay out on packing table or other suitable area.

**REPLACE**

1. Remove reserve ripcord grip from pocket and pull, removing ripcord cable from housing.
2. Carefully cut and remove two (2) tackings securing housing to container and remove housing.

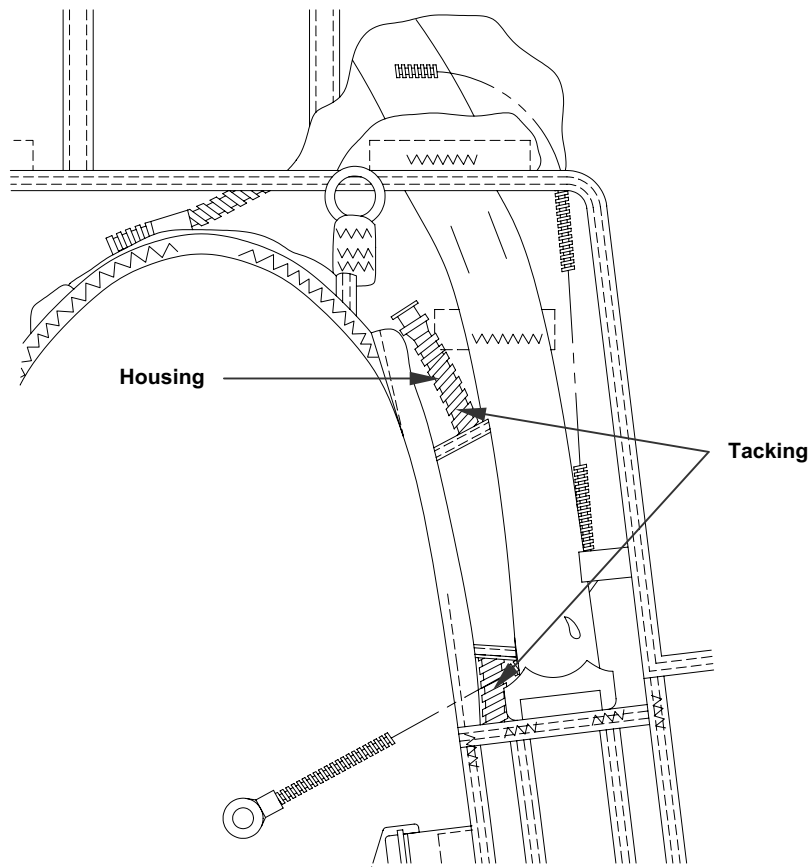

3. Insert replacement ripcord housing through cover on container.

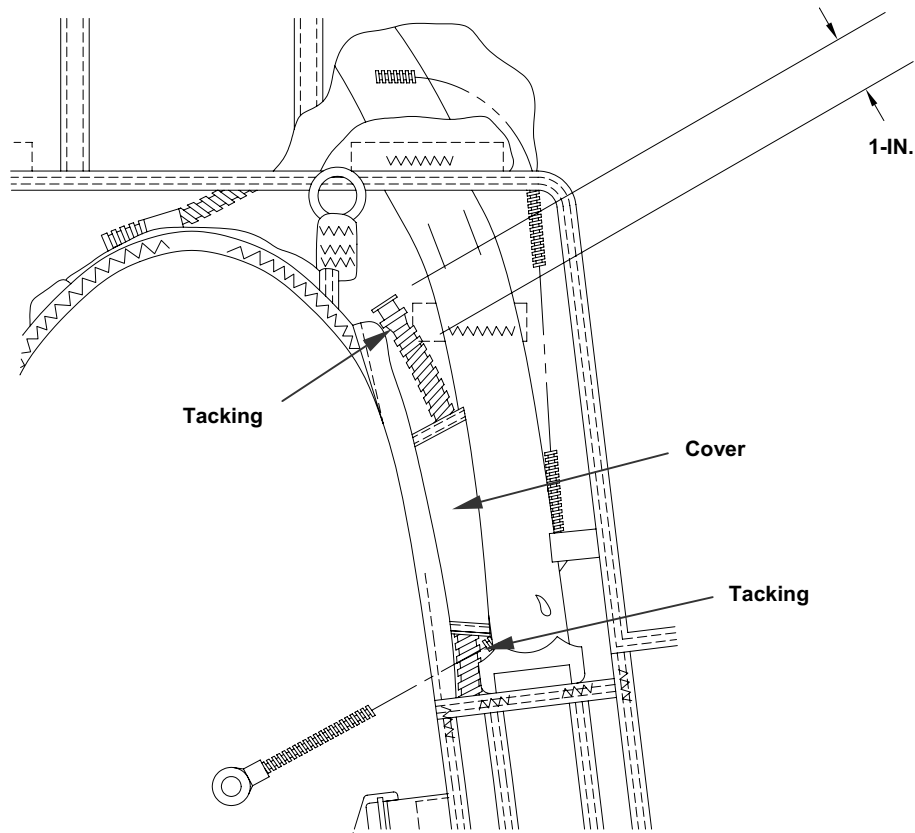

4. Tack lower end of housing in position from underside of container. Use five, turns of nylon lacing tape, doubled. Fifth turn is placed over fourth turn around groove in ferrule. Secure with surgeon's knot and locking knot. Trim free ends  $\frac{3}{4}$ -inch from knot.
5. Leaving 1-inch of housing free to flex, tack other end of housing in position from underside of container. Use five (5) turns of nylon lacing tape, doubled. Fifth turn is placed over fourth turn at ferrule end. Secure with surgeon's knot and locking nut. Trim free ends  $\frac{3}{4}$ -inch from knot.

**END OF WORK PACKAGE**

---

**UNIT MAINTENANCE**  
**MC-4 RAM AIR FREE-FALL PERSONNEL PARACHUTE SYSTEM**  
**MAIN RIPCORD HOUSING**

---

**THIS TASK COVERS:**

- Replace

**INITIAL SETUP:****Tools**

Needle, Tacking (Item 29, WP 0063 00)  
Shears (Item 39, WP 0063 00)  
Tape Measure (Item 42, WP 0063 00)

**Equipment Condition**

Lay out on packing table or other suitable area.

**Materials/Parts**

Housing, Ripcord, 33-IN. (Item 12, WP 0071 00)  
Tape, Lacing and Tying (Item 33, WP 0076 00)

**Personnel Required**

92R (10) Parachute Rigger

---

**REPLACE**

1. Remove main ripcord grip from pocket and pull, removing ripcord cable from housing.
2. Carefully cut and remove tacking at upper end of housing.

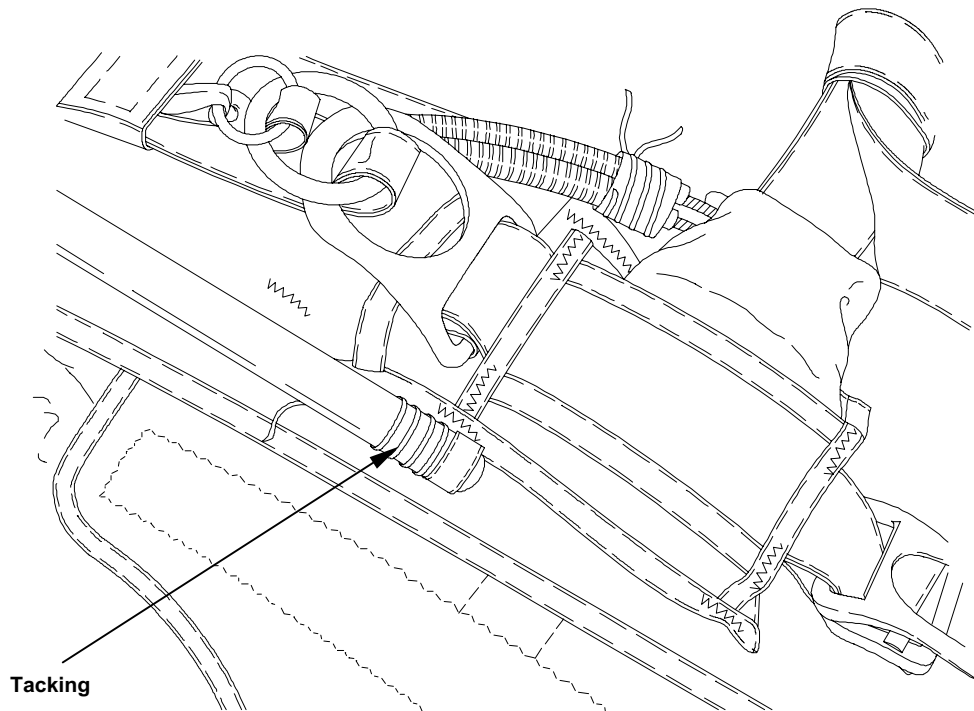

3. At lower end of housing, carefully cut and remove tacking from housing and housing cover. Remove housing from cover.

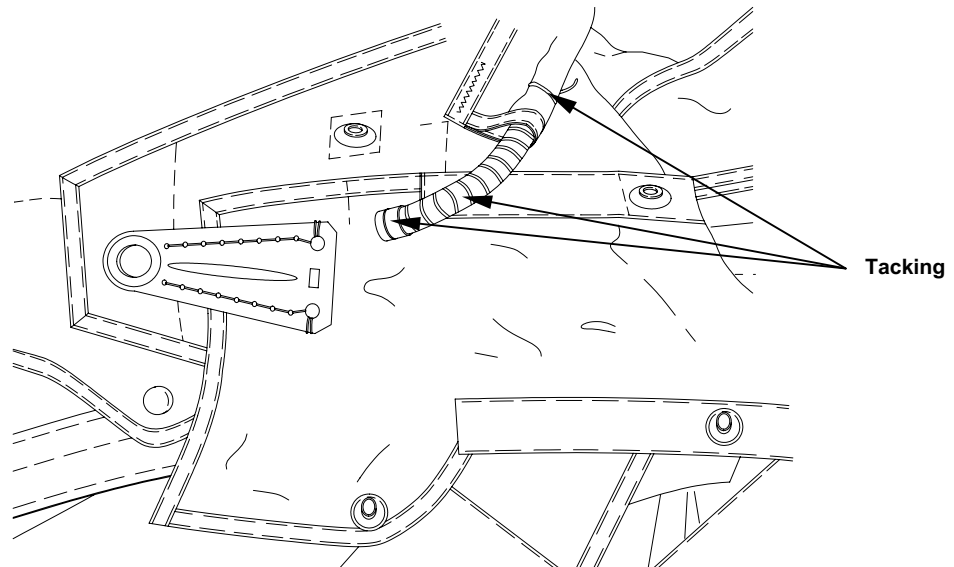

4. Insert replacement ripcord housing through cover on container. Align upper end of housing with end of housing cover and tack in place from underside of cover. Use four turns of tape, lacing and tying, doubled. Secure with surgeon's knot and locking knot. Trim free ends  $\frac{3}{4}$ -inch from knot.

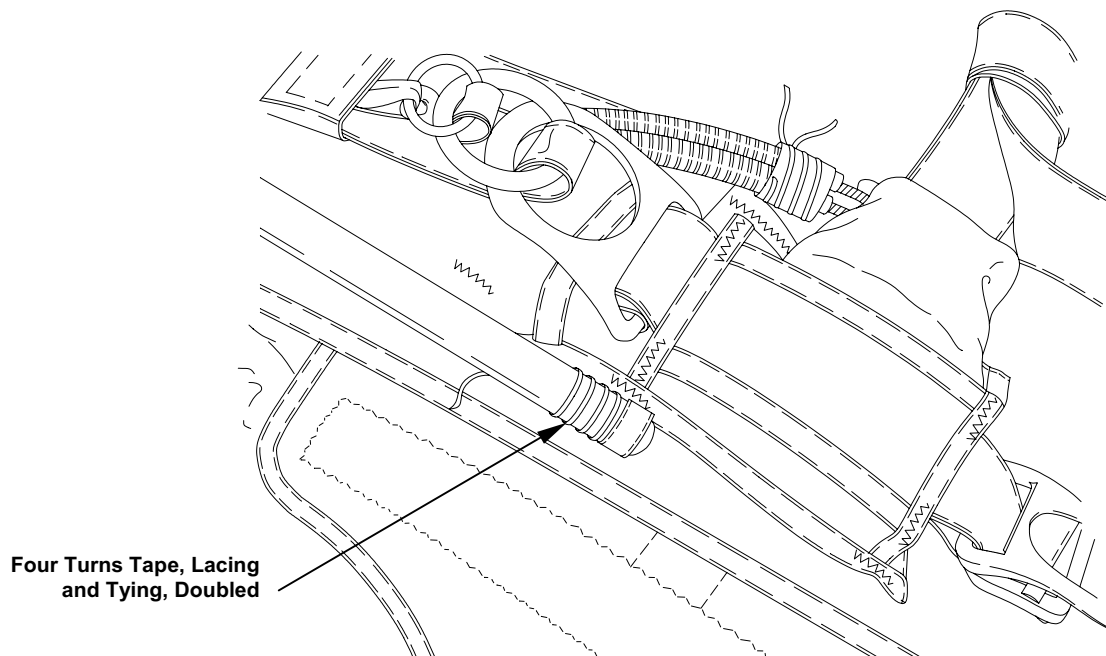

5. Tack other end of cover around housing with one turn of tape, lacing and tying, doubled. Secure with surgeon's knot and locking knot. Trim free ends  $\frac{3}{4}$ -inch from knot. Tack lower end of housing to container with four turns of tape, lacing and tying, doubled. Secure with surgeon's knot and locking knot. Trim free ends  $\frac{3}{4}$ -inch from knot.

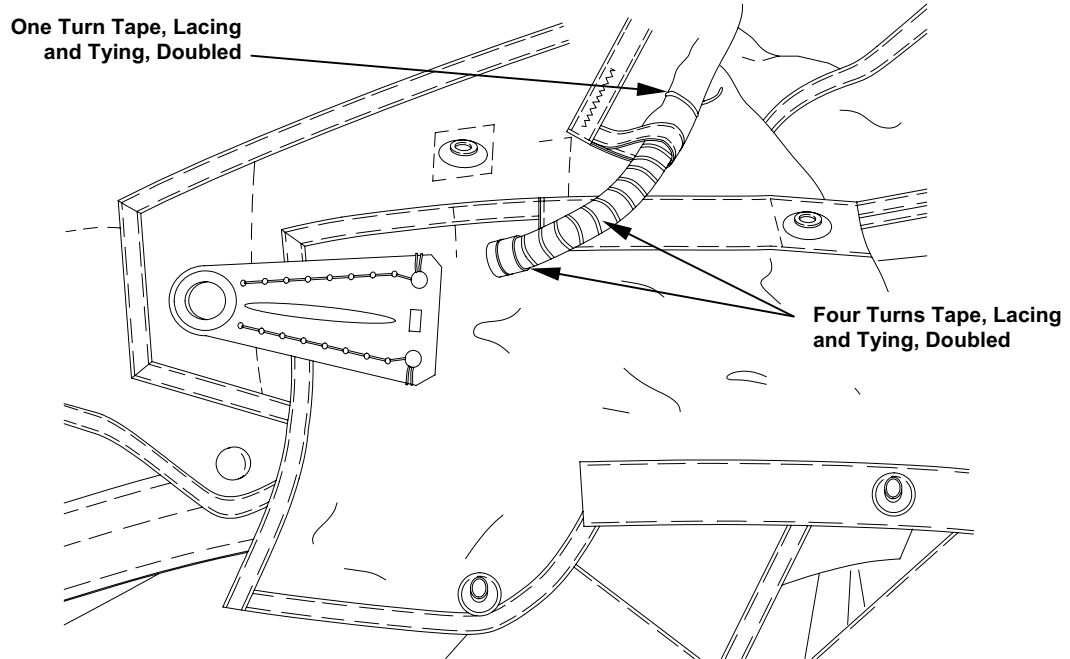

**END OF WORK PACKAGE**





---

**UNIT MAINTENANCE**  
**MC-4 RAM AIR FREE-FALL PERSONNEL PARACHUTE SYSTEM**  
**AAD JUNCTION PLATE**

---

**THIS TASK COVERS:**

- Replace
- 

**INITIAL SETUP:**

**Tools**

Die Sets, Spur Grommet, No. 2 (Item 18, WP 0063 00)  
 Knife, Hot Metal (Item 24, WP 0063 00)  
 Mallet, Rawhide (Item 27, WP 0063 00)  
 Needle, Tacking (Item 29, WP 0063 00)  
 Pliers, Large, Diagonal Cut (Item 32, WP 0063 00)  
 Shears (Item 39, WP 0063 00)

**Equipment Condition**

Main canopy removed from container. Lay out on packing table or other suitable area.

**Personnel Required**

92R (10) Parachute Rigger

**Materials/Parts**

AAD Junction Plate (Item 15, WP 0071 00)  
 Cloth, Abrasive (Item 6, WP 0076 00)  
 Grommet, Rolled Rim, Spur Washer, 305 Stainless Steel, No. 2 (Item 24, WP 0076 00)  
 Tape, Lacing and Tying (Item 33, WP 0076 00)

---

**REPLACE**

1. Carefully cut and remove tacking securing base plate to container side flap.

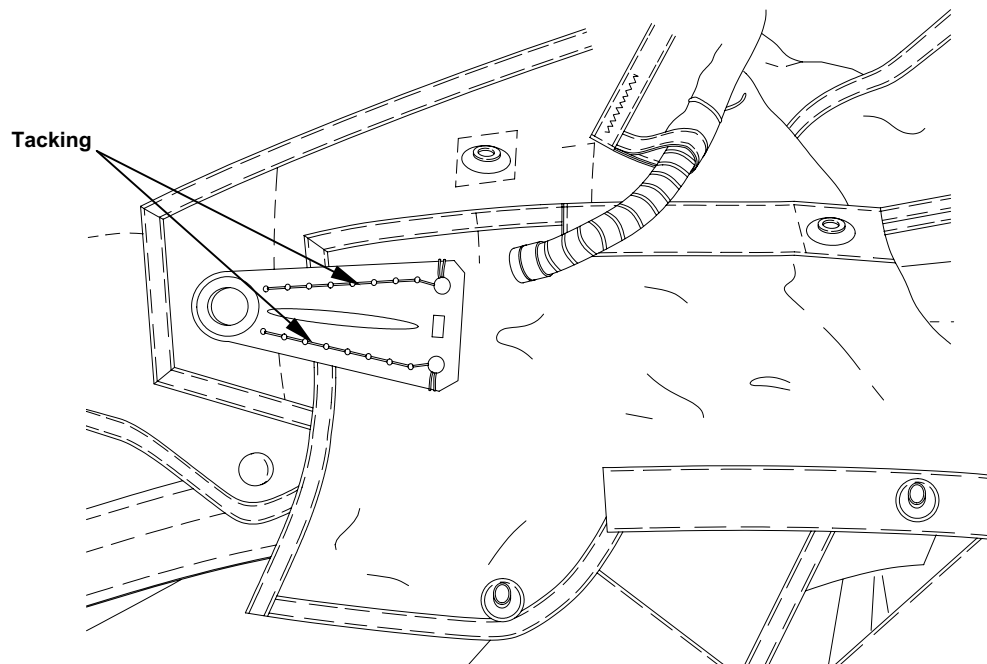

2. Remove original grommet as follows:
  - a. Using diagonal cut/lineman pliers, lift edge of original washer at one point.
  - b. Grip lifted washer edge with pliers and roll washer edge back to lift washer from original grommet. Remove original grommet from material.
  - c. Remove AAD Junction plate.

NOTE

If replacing the AAD Junction Plate ONLY, due to an unserviceable AAD Junction Plate, follow the mounting instructions IAW paragraph 3., below.

If replacing the AAD Junction Plate due to an unserviceable right flap plastic stiffener, drill holes may not be present in the stiffener preventing the entire AAD Junction plate from being tacked down. Follow the mounting instructions IAW step 7., detailed on the following page.

3. Position replacement AAD Junction plate in same location as unserviceable AAD Junction plate.
4. Tack AAD Junction plate to side flap using tape, lacing and tying, single. Starting on inside of side flap, pass lacing tape up through one of the large round holes on wide end of AAD Junction plate. Continue to stitch through holes on that side of AAD Junction plate until opposite end is reached, then return stitching through holes back to starting point. Secure with surgeon's knot and locking knot. Trim free ends  $\frac{3}{4}$ -inch from knot.
5. Repeat step 4., on other side of AAD Junction plate.
6. Replace grommet as follows:
  - a. Insert barrel of replacement grommet through accommodating hole in material and ensure grommet flange is located on same side of material as original grommet.
  - b. Position grommet on die with barrel facing up and place washer over grommet barrel. Ensure grommet barrel and washer are aligned to prevent off-center setting of grommet.

- c. Using a punch and rawhide mallet or other non-steel impact device, spread grommet barrel by hammering until barrel collar is rolled down smooth on washer. If grommet barrel splits during hammering, remove and replace installed grommet with a serviceable item from stock. Repeat the procedure in steps b. and c., above.

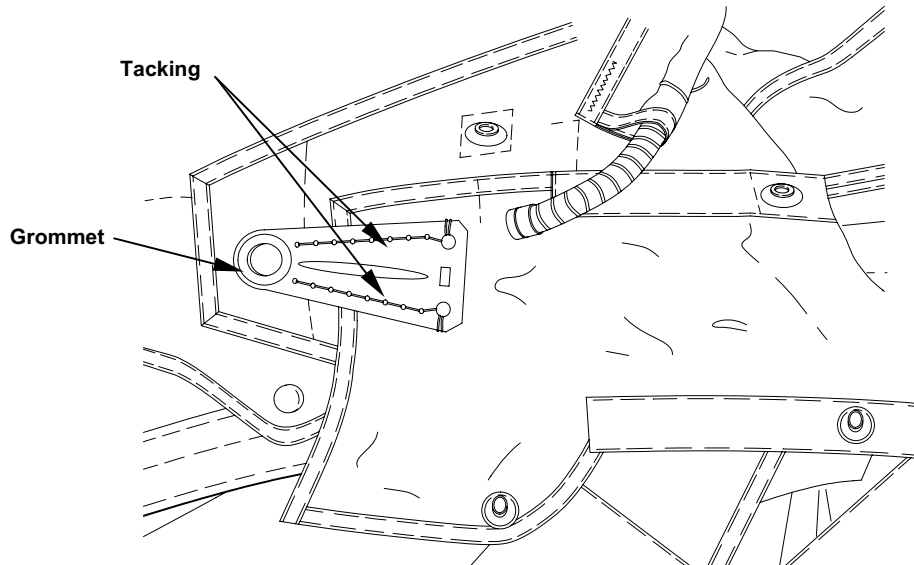

7. Tack AAD Junction plate to side flap using tape, lacing and tying, single. Starting on inside of side flap, pass lacing tape up through one of the large round holes on wide end of AAD Junction plate. Continue to tack through holes on that side of AAD Junction plate until reaching the stitching securing the stiffener (6<sup>th</sup> small hole), then return stitching through holes back to starting point. Secure with surgeon's knot and locking knot. Trim free ends  $\frac{3}{4}$ -inch from knot.
8. Repeat step 7., on other side of AAD Junction plate.
9. Replace grommet IAW step 6., above.

**END OF WORK PACKAGE**



**UNIT MAINTENANCE**  
**MC-4 RAM AIR FREE-FALL PERSONNEL PARACHUTE SYSTEM**  
**AR2 RIPCORD RELEASE POCKET (PADDED)**

**THIS TASK COVERS:**

- Replace (Mounting)

**INITIAL SETUP:**

**Tools**

Sewing Machine, Medium-Duty (Table 1, WP 0015 00)  
 Sewing Machine, Zig-Zag (Table 1, WP 0015 00)  
 Stitch Removal Tool (Item 40, WP 0063 00)

**Material/Parts**

Pocket, Assembly (Padded), AR2 (Item 15, WP 0065 00)  
 Thread, Nylon, Size E (Item 43/44, WP 0076 00)  
 Thread, Nylon, Size FF (Item 42, WP0076 00)

**Personnel Required**

92R (10) Parachute Rigger

**Equipment Condition**

Layout on packing table or other suitable area.

**REPLACE (Mounting)**

1. Remove the stitching that secures the waistband end adjuster to the left wing flap.
2. Place a mark  $\frac{1}{8}$ -inch from the flap/container seam. Place an additional mark on the lower edge binding  $2\frac{1}{2}$ -inches from the flap/container seam.
3. Position the AR2 Pocket on the outside of the left wing flap.

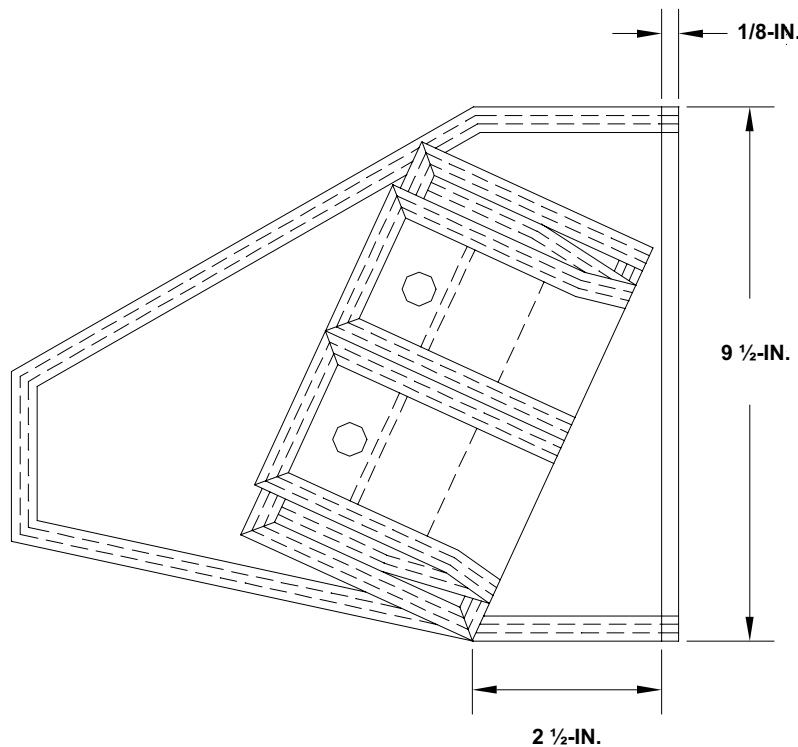

4. After aligning the upper and lower right corners of the pocket, the pocket may overhang in other places. If this occurs, do not change the angular orientation of the pocket, just capture as much of the pocket boarder when attaching to the wing flap. Also, if the attaching stitching cannot be continuous, backstitch where appropriate in order to lock the stitch.
5. Using a medium-duty sewing machine and size FF nylon thread, 5 to 8 stitches per inch, or two (2) rows of size E nylon thread, 7 to 11 stitches per inch, secure the pocket to the flap.
6. Using a medium-duty zig-zag sewing machine, and size E nylon thread, re-secure the waistband adjuster to the left wing flap with two (2) rows of stitching.

**END OF WORK PACKAGE**

---

**UNIT MAINTENANCE**  
**MC-4 RAM AIR FREE-FALL PERSONNEL PARACHUTE SYSTEM**  
**AR2 POWER CABLE ASSEMBLY INSTALLATION/MOUNTING**

---

**THIS TASK COVERS:**

- Repair
  - Replace
  - Installation of AR2 Power Cable Assembly, Reserve
  - Installation of AR2 Power Cable Assembly, Main
  - Removal of AR2 Power Cable Assembly, Reserve
  - Removal of AR2 Power Cable Assembly, Main
- 

**INITIAL SETUP:****Tools**

Bit, Drill,  $\frac{5}{32}$ -IN. (Item 2, WP 0063 00)  
 Drill, Electric,  $\frac{3}{8}$ -IN. (Item 14, WP 0063 00)  
 Punch, Center (Item 36, WP 0063 00)  
 Screwdriver, Phillips (Item 38, WP 0063 00)  
 Sewing Machine, Bartack, (42 stitch) (Table 1, WP 0015 00)  
 Sewing Machine, LD (Table 1, WP 0015 00)  
 Sewing Machine, MD (Table 1, WP 0015 00)  
 Sewing Machine, MD Zig-Zag (Table 1, WP 0015 00)  
 Stitch Removal Tool (Item 40, WP 0063 00)  
 Wrench, Adjustable, 6-IN. (Item 46, WP 0063 00)

**Personnel Required**

92R (10) Parachute Rigger

**Equipment Condition**

Layout on packing table or other suitable area.

**Material Parts**

AAD Junction Plate, Main (Item 15, WP 0071 00)  
 Alcohol, Isopropyl (Anhydrous) (Item 3, WP 0076 00)  
 Clamp (Item 10, WP 0071 00)  
 Cloth, Lint Free, Cleaning (Item 8, WP 0076 00)  
 Cloth, Duck, Textured Nylon, CG (Item 7, WP 0076 00)  
 Nut (Item 11, WP 0071 00)  
 Plate, Backing (Item 9, WP 0071 00)  
 Screw (Item 2, WP 0071 00)  
 Tape, Lacing and Tying (Item 33, WP 0076 00)  
 Tape, Nylon, Type III,  $\frac{3}{4}$ -IN. Wide (Item 37, WP 0076 00)  
 Thread, Nylon, Size E (Item 43/44, WP 0076 00)  
 Thread, Nylon, Size FF (Item 42, WP 0076 00)

---

**REPAIR**

If loose or broken threads are present, restitch with size FF thread in accordance with this WP and WP 0015 00.

**REPLACE**

Replace damaged power cable sleeve as follows:

---

**NOTE**

---

If packed, unpack both main and reserve parachutes. Disconnect main parachute. It is not required to disconnect reserve parachute.

1. Cut and sear an 18 1/2-inch length of Tape, Nylon, Type III, OD, 3/4-inch wide binding tape.
2. Cut and sear a 16 1/2-inch x 3-inch piece of green textured nylon duck cloth.

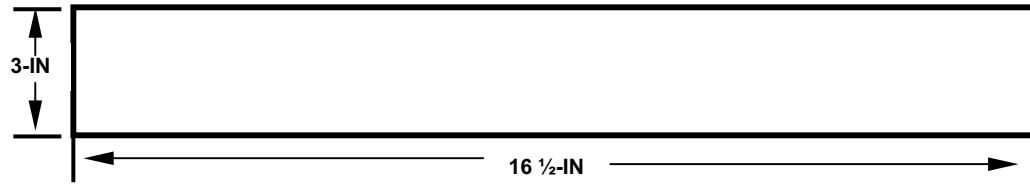

3. On the 3-inch length, fold ends under 1/2-inch and sew with a light-duty sewing machine, type 301, and size E nylon thread, 7 to 11 stitches per inch. Backstitch not less than 1/2-inch.

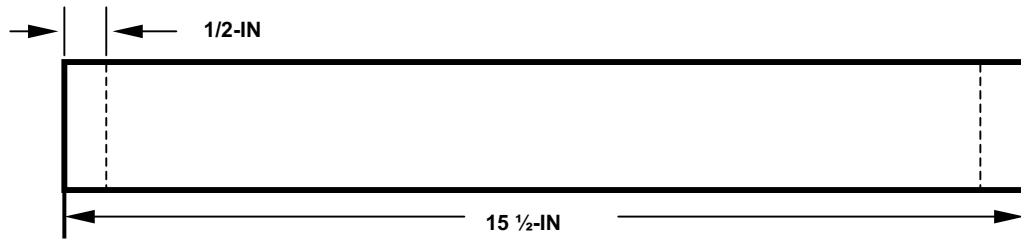

4. With raw edges inside, fold in half, lengthwise. Join folded fabric together using 3/4-inch green nylon binding tape. Equal the excess length of binding tape on both ends of the sleeve. Sew one (1) row with a light-duty sewing machine, type 301, and size E nylon thread, 7 to 11 stitches per inch. Backstitch not less than 1/2-inch.
5. Pre-mark sleeve on both sides of binding tape. Starting from one end, measure 1-inch, 7 1/2-inches, and 8 1/2-inches. From other end, measure 1-inch.

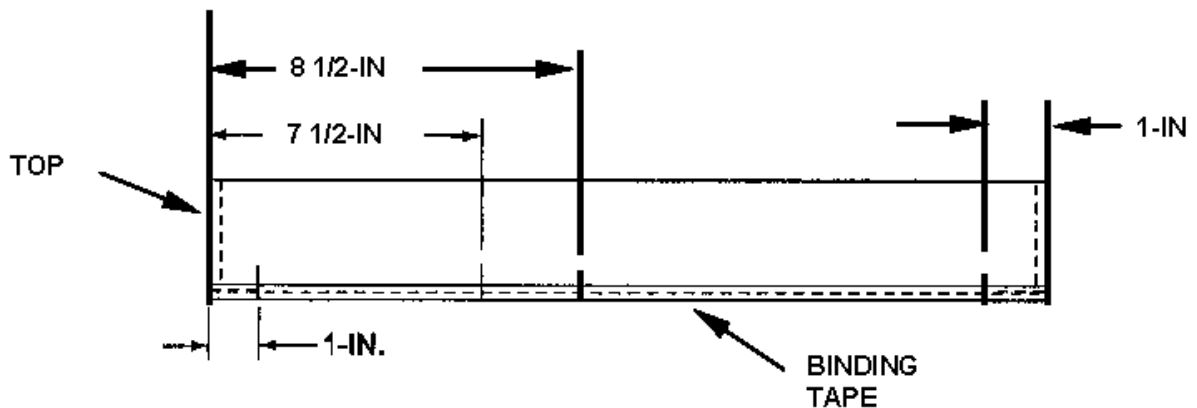



---

**INSTALLATION OF AR2 POWER CABLE ASSEMBLY, RESERVE**

1. Install AR2 power cable sleeve as follows:

NOTE

Prior to installing the AR2 power cable sleeve, the main and reserve parachutes must be completely unpacked.

- a. Position harness/container assembly on work surface with pack tray facing down and AR2 padded pocket at the bottom right.
- b. Measure and mark 2-inches from center of the power cable opening located at the top of the harness/container assembly between the risers.
- c. Align the TOP end of the AR2 power cable sleeve end with the harness/container assembly's 2-inch mark.
- d. Make a mark approximately 2-inches long, parallel to top of the weapon tie-down loop.
- e. Fold under the excess binding tape and stitch AR2 power cable sleeve to the container with three (3) continuous rows of backstitching from the end of the sleeve to the 1-inch mark with a medium-duty sewing machine, type 301, and size FF thread, 6 to 9 stitches per inch.
- f. The portion of the sleeve (approximately 6 ½-inches) to the 7 ½-inch location mark, as identified in the illustration, is not attached to the container.
- g. Align the 7 ½-inch location mark on the AR2 power cable sleeve with the top of the harness/container assembly weapon tie down loop.
- h. At this location, stitch remainder of AR2 power cable sleeve to harness/container assembly with three (3) continuous rows of backstitching for 1-inch.
- i. Fold under excess binding tape. Sew remainder of the sleeve (approximately 8-inches) to the container and finish with a total of three (3) continuous rows of 1-inch backstitching.

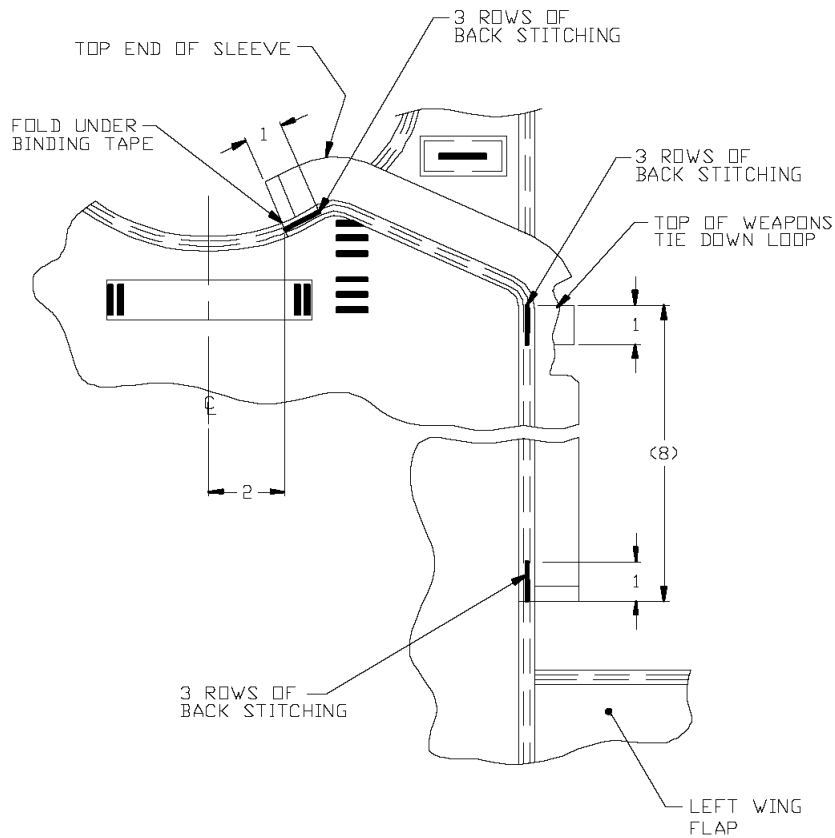

2. Install AR2 Power Cable Assembly, Reserve as follows:

- a. Place container on work surface with pack tray facing down and AR2 pocket at the bottom right.

**NOTE**

Periodic maintenance of the power cable assembly is required to insure proper operation. As a guide, follow the interval periods contained in TM 10-1670-305-23&P, WP 0018 00. If required, removal, disassembly, cleaning, inspection and assembly instructions are also contained in TM 10-1670-305-23&P, WP 0019 00.

- b. Clean exterior of power housing by wiping with a clean, lint-free cloth moistened with anhydrous isopropyl alcohol.
- c. Clean all metal parts (except power housing) by washing in anhydrous isopropyl alcohol and dry thoroughly.
- d. Visually inspect all components for wear or damage.
- e. Discard worn or damaged parts.

- f. Visually inspect entire power cable for fraying of cable or broken strands of wire. Discard if worn or damaged.
- g. Route the AR2 power cable through the lower open end of the AR2 power cable sleeve located above the AR2 padded pocket.
- h. Continue routing the AR2 power cable from bottom of AR2 power cable sleeve to top of AR2 power cable sleeve opening. Route AR2 power cable between the reserve parachute top flap and the reserve ripcord pin protector flap.
- i. Secure the end of the AR2 power cable to the reserve base plate assembly, using the clamp, screws and locking nuts.
- j. Pack main and reserve parachute assemblies.
- k. Conduct the Slack Checker Test (WP 0011 00) and Stroke Simulator Test (WP 0013 00).

### INSTALLATION OF AR2 POWER CABLE ASSEMBLY, MAIN

1. Prepare the AR2 Power Cable Assembly, Main as follows:

#### NOTE

The following Harness/Container modification procedures are applicable for MC-4s or Harness/Containers (spare parts) that were purchased prior to June 2002. All MC-4s and Harness/Containers purchased after June 2002 have been manufactured with a modified Automatic Activation Device (AAD) Junction Plate and an existing hole above the left wing flap to accommodate the mounting of the AR2 Power Cable, Main.

- a. Remove reserve parachute from container.
- b. Place container on work surface with pack tray facing down and AR2 pocket at the bottom right.
- c. Measure up 9 ½-inches from the bottom edge of the left wing flap and mark.
- d. From the 9 ½-inch mark, measure up 1 ¾-inches and mark. Remove the stitching to construct an opening 1 ¾-inches in length.
- e. Make a one-inch stitch (backstitch) on both sides of the 1 ¾-inch hole utilizing either a bartack or zig-zag sewing machine. If a Bartack sewing machine is used, use thread, nylon, size E, 42 to 48 stitches per inch. If a zig-zag sewing machine is used, use thread, nylon, size FF, 20 stitches per inch leaving a 1 ¾-inch power cable opening.
- f. Measure up 5 ½-inches up from the bottom edge of the right wing flap, along the seam where the flap is sewn to the container and mark.
- g. From the 5 ½-inch mark, measure up 1 ¾-inches and mark. Remove the stitching to construct an opening 1 ¾-inches in length.

- h. Make a one-inch stitch (backstitch) on both sides of the 1 3/4-inch hole utilizing either a bartack or zig-zag sewing machine. If a bartack sewing machine is used, use thread, nylon, size E, 42 to 48 stitches per inch. If a zig-zag sewing machine is used, use thread, nylon, size FF, 6 to 9 stitches per inch leaving a 1 3/4-inch power cable opening.

NOTE

If possible, use NEW component parts (AAD Junction plate, clamp, screws and nuts) to mount the AR2 Power Cable Assembly to the MC-4 main parachute. However, if the clamp has been removed from the reserve flap, replace the screws and nuts.

- 2. Modify the AAD Junction Plate as follows:

NOTE

If modifying an existing junction plate manually, the user MUST ensure that an accurate measuring device (metal scale) is used to establish the critical dimensions as shown below.

- a. Carefully measure and pre-mark the junction plate. Measurements are to the center of the holes.
- b. Using a 5/32-inch drill bit, drill two holes to accommodate placement of the clamp as shown.

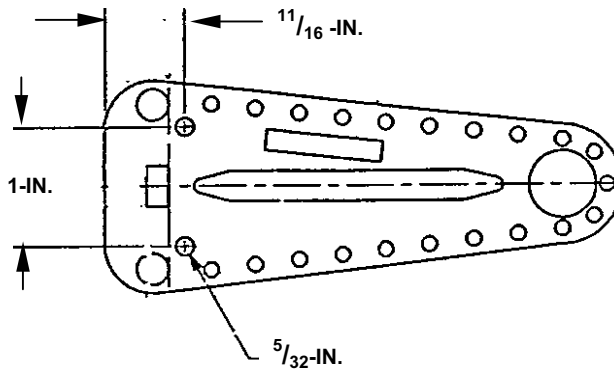

- c. Place backing plate on the backside of the junction plate and install clamp using two screws and two nuts. Hand-tighten at this time.

3. Install AR2 Power Cable Assembly, Main follows:

- a. Starting at the left wing flap, route the power cable housing through the 1 3/4-inch hole located above the AR2 pocket.

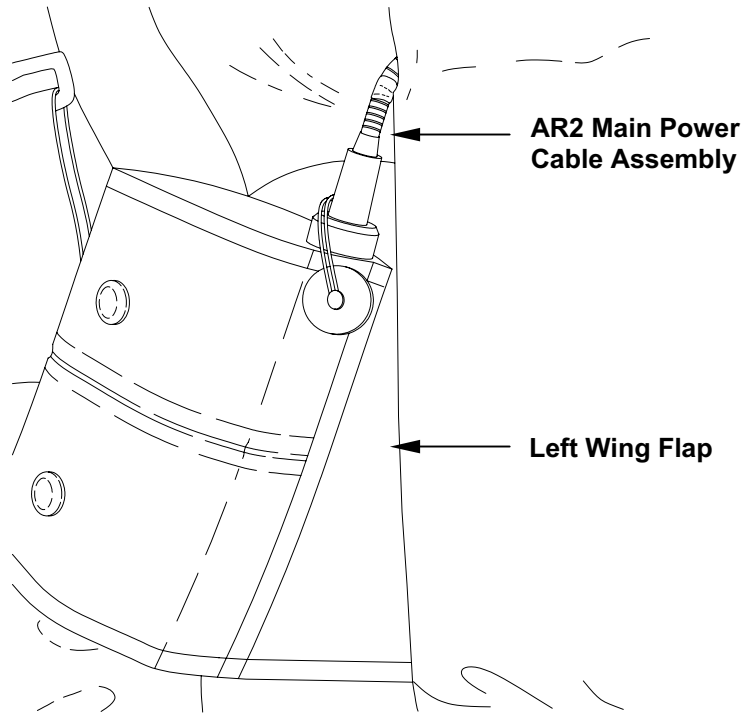

- b. Pass the power cable through the inside of the container, ensuring the power cable passes over the diagonal back straps, and out through the 1 3/4-inch hole on the right side of the container.

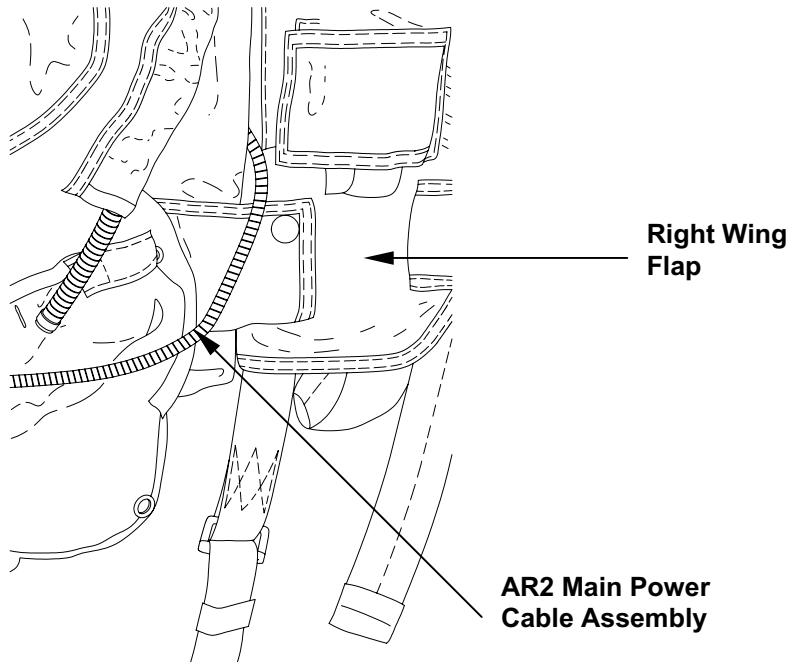

- c. Using the adjustable wrench and a Phillips head screwdriver, secure the end of the power cable to the AAD junction plate utilizing the clamp previously installed. Wrench tight approximately  $\frac{1}{4}$  turn.

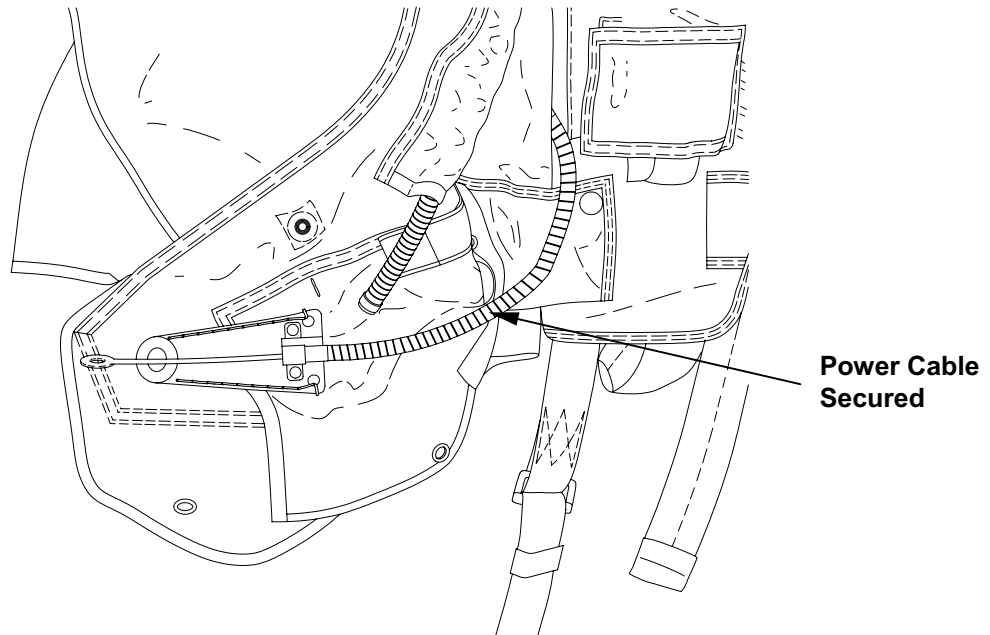

- d. Conduct the Stroke Simulator Test (WP 0014 00).

#### REMOVAL OF AR2 AND POWER CABLE ASSEMBLY, RESERVE

1. Ensure that the AR2 JUMP/OFF switch is in the OFF position.

#### NOTE

If AR2 has not actuated, go to step 6.

2. If the AR2 has actuated, remove the AR2 and its power cable assembly from the reserve base plate assembly by removing the two screws, nuts and clamp. These parts (hardware) are accessories attached to the reserve base plate.
3. Remove the power cable from between the reserve parachute top flap and the reserve ripcord pin protector flap.
4. Remove the AR2 from the pocket and slowly pull down on the AR2 and power cable removing the cable through the lower open end of the power cable sleeve.
5. Insert a screwdriver or other suitable tool through eye of power cable to form a T-handle. Secure AR2. Pull eye of power cable until the AR2 mechanism reaches the cocked position and power cable remains extended from power housing (requires approximately 70-pounds pull).

6. Remove the AR2 and Power Cable Assembly as follows:
  - a. Remove AR2 from pocket and unscrew power-housing retainer from spring housing and remove the AR2 from power cable assembly by disengaging ball of power cable from piston rod. Attach storage cable and piston rod cap to AR2.

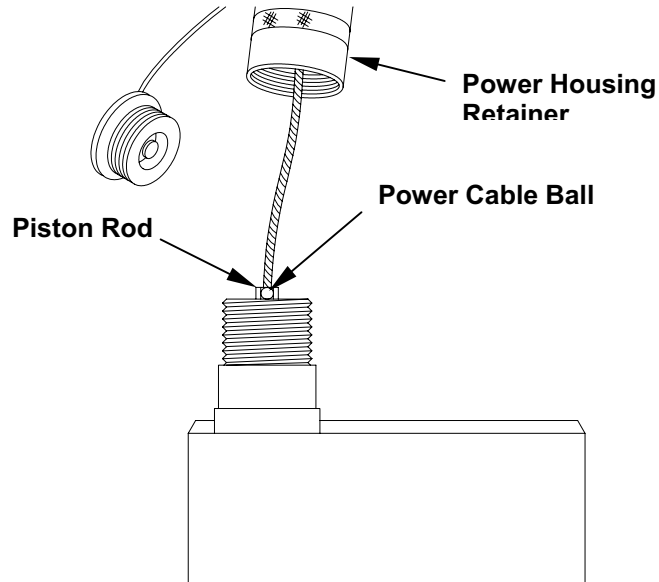

- b. Remove the power cable assembly from the parachute by removing the two (2) screws, nuts and clamp. These parts (hardware) are accessories attached to the reserve base plate.
- c. Remove the power cable from between the reserve parachute top flap and the reserve ripcord pin protector flap.
- d. Slowly pull down on the power cable removing it through the lower open end of the power cable sleeve.

#### REMOVAL OF AR2 AND POWER CABLE ASSEMBLY, MAIN

1. Ensure that the AR2 JUMP/OFF switch is in the OFF position.

#### NOTE

- If AR2 has not actuated, go to step 5.
2. If the AR2 has actuated, remove the AR2 and its power cable assembly from the AAD Junction plate by removing the two screws, nuts, backing plate and clamp. These parts (hardware) are accessories attached to the AAD Junction plate.
  3. Remove the AR2 from the pocket and slowly pull the AR2 and power cable through the 1 3/4-inch hole on the right side of the container, through the inside of the container and out through the 1 3/4-inch hole located above the AR2 pocket.

4. Insert a screwdriver or other suitable tool through eye of power cable to form a T-handle. Secure AR2. Pull eye of power cable until the AR2 mechanism reaches the cocked position and power cable remains extended from power housing (requires approximately 70-pounds pull).
5. Remove the AR2 and Power Cable Assembly as follows:
  - a. Remove AR2 from pocket and unscrew power-housing retainer from spring housing and remove the AR2 from power cable assembly by disengaging ball of power cable from piston rod. Attach storage cable and piston rod cap to AR2.

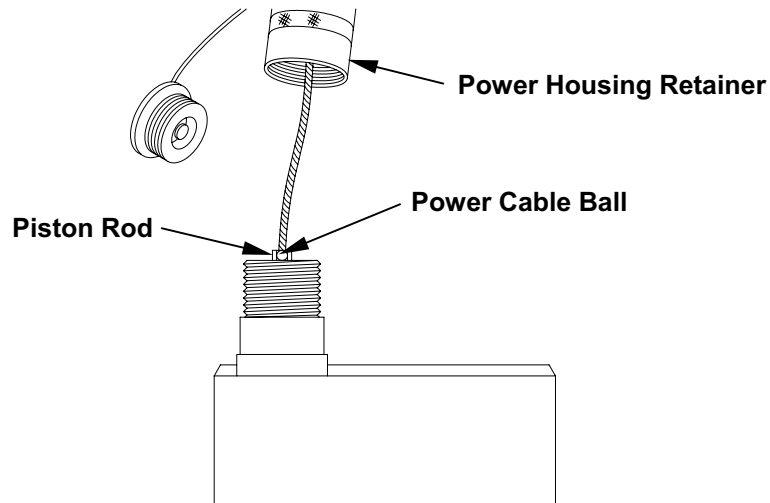

- b. Remove the power cable assembly from the AAD Junction plate by removing the two (2) screws, nuts, backing plate and clamp. These parts (hardware) are accessories attached to the AAD Junction plate.
- c. Remove the power cable through the 1  $\frac{3}{4}$ -inch hole on the right side of the container, through the inside of the container and out through the 1  $\frac{3}{4}$ -inch hole located above the AR2 pocket.

**END OF WORK PACKAGE**



---

**UNIT MAINTENANCE  
MC-4 RAM AIR FREE-FALL PERSONNEL PARACHUTE SYSTEM  
POROSITY PROCEDURES**

---

**THIS TASK COVERS:**

- Inspection
- 

**INITIAL SETUP:****Tools**

Porosity Machine (Item 33, WP 0063 00)

**Personnel Required**

92R (10) Parachute Rigger

**Equipment Condition**

Layout on packing table or other suitable area.

---

**POROSITY INSPECTION CRITERIA**

1. The following techniques and standards have been provided to summarize and/or clarify the desired design characteristics regarding factors deemed important to the inflation reliability of military ram air canopies. These standards are intended to assist military riggers responsible for the inspection and maintenance of ram air personnel parachutes in the identification of canopies, which possess characteristics, which have been associated with non-airworthy canopies.
2. Where none had previously existed, tolerances are added to standards, which are intended to define the maximum acceptable limits of deviation from these desired characteristics. A point system was devised which will be used to determine the degree of compliance of a particular canopy to the desired design characteristics. This point scoring system appropriately prioritizes and emphasizes the issues affecting inflation reliability and general canopy airworthiness. Although a canopy may not exceed any of the established tolerances, the cumulative effect of multiple minor deviations may also condemn a canopy.
3. These procedures are intended to assist the inspecting rigger in identifying canopies, which may exhibit non-airworthy characteristics. The below procedures will be added to the current standard inspection criteria and be conducted during in-servicing, every year for land rigs, every five (5) jumps or one year for water rigs (whichever comes first), and when canopies exhibit poor performance characteristics during deployment, flight, and/or landing. When a canopy exhibits non-airworthy characteristics and a permeability-testing machine is not available, the canopy will be removed from service regardless of the remaining service life.
4. These procedures apply exclusively to the MC-4, however, the MTI-X, and MTI-S model canopies are also considered within the family of Ram-Air Personnel Parachute Systems (RAPPS). The procedures, techniques and parameters are as follows:
  - a. Procedure number 1. Fabric Permeability Test:
    - (1) This procedure requires use of a permeability-testing machine. The machine should be calibrated and operated in accordance with the manufacturer's specifications. Record permeability measurements at a 0.5-inch (water) pressure head (vacuum) differential.

---

**NOTE**

---

Testing the fabric along the nose of the top surface is intended to characterize a canopy's ability to inflate in a reasonable period of time. Users are encouraged to test other areas of the canopy to identify sources of other flight performance problems. For example, high permeability readings in the tail section may be indicative of a reduction in flair maneuver performance. If certain sections have unusually high readings, the rigger should use his/her judgment as to what corrective action needs to be taken.

**NOTE**

Personnel conducting permeability tests should be alert to anomalies in the color of the canopy fabric. Localized discolorations are evidence of exposure to environmental contaminants. A change in color shade from one (1) canopy section/surface to another is an indication that the canopy may have been manufactured from different lots of fabric. In either case, a permeability check should be made on these areas of concern.

- (2) For best results, the canopy should lie in an unpacked, unstressed condition for 24-hours prior to testing. Care should be taken not to physically stress the canopy fabric during handling and testing.
- (3) Take a permeability reading in each cell of the canopy on the top surface (i.e. the MC-4 is a seven (7) cell canopy so seven readings will be taken). Readings can be taken from either sub cell. Readings should be taken approximately 18-inches aft of the leading edge nose tape and should be roughly centered within the sub cell.
- (4) If it is necessary to take a second reading within a cell, move to an untested area of fabric at least 6-inches away (in any direction) from the location of the previous measurement.
- (5) Calculate the average permeability of all readings recorded along the top surface nose section of the canopy. Record this value.
- (6) The desired average permeability for a new canopy manufactured with PIA-C-44378 (1.1 oz.) fabric should be in the range of 0-5 ft.<sup>3</sup>/min./ft.<sup>2</sup> (cfm).
- (7) The maximum limit for a new, unused canopy is 6.0-cfm. Any new, unused canopy having a permeability value of 6.0-cfm or greater will not be placed in service since its useful life can be expected to be shorter than that of a properly manufactured canopy.
- (8) During the service life of a canopy, if the average permeability along the top surface nose is 12.0-cfm or greater, the canopy will be immediately and permanently removed from service.

b. Procedure number 2. Measurement of Top Surface Cell Widths:

- (1) This procedure requires use of a tape measure. Lay the canopy out spanwise on a clean surface. Using approximately two pounds of tension, measure the nose tape span of each cell along the top surface of the canopy, from loaded rib to loaded rib (see illustration below). Loaded ribs are those which have V-tapes and line attachment points.

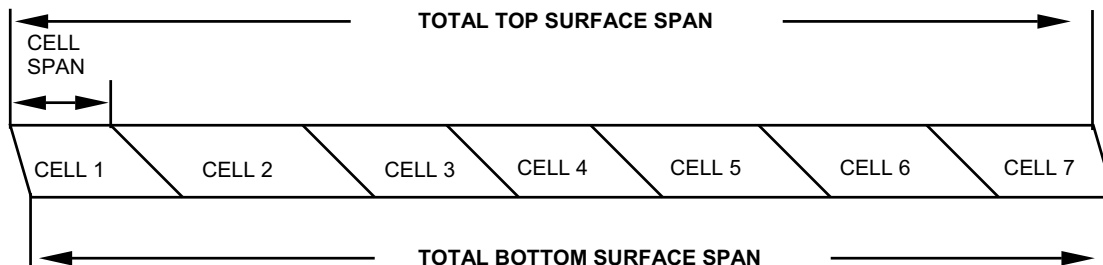

- (2) Record the span measurement for each cell along with the corresponding cell identifier (i.e. Cell 1, 2, 3, etc.).
- (3) Calculate the average cell span for the canopy. Record this value.
- (4) The relevant cell span measurements are:

CANOPY MODEL	LOWER LIMIT	DESIRED RANGE	UPPER LIMIT
MC-4	47-inches	48 to 50-inches	50-inches
MTI-X	45-inches	46 to 48-inches	48-inches
MTI-S	47-inches	48 to 50-inches	50-inches

- (5) Any canopy, that has a cell span, that falls below the corresponding lower limit or exceeds the upper limit, will be deemed unacceptable and will be immediately and permanently removed from service.

c. Procedure number 3. Measurement of Top/Bottom Surface Span Differential:

- (1) This procedure requires use of a tape measure. In the same manner as above, measure and record the nose tape span for each cell along the bottom surface of the canopy from loaded rib to loaded rib.
- (2) Calculate the sum of all top surface nose tape span measurements to determine the total top surface span. Record this value.

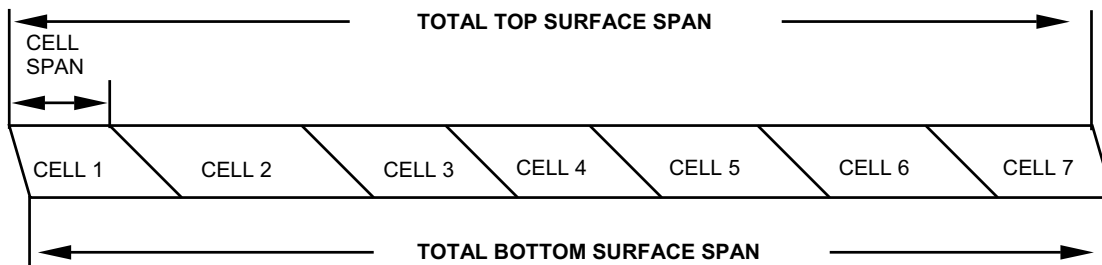

- (3) Calculate the sum of all bottom surface nose tape span measurements to determine the total bottom surface span. Record this value.
- (4) Subtract the total bottom surface span from the total top surface span to obtain a top/bottom surface span differential. Record this value.
- (5) Top/bottom surface span differentials should fall within the following ranges:

CANOPY MODEL	LOWER LIMIT	DESIRED RANGE	UPPER LIMIT
MC-4	5-inches	6 <sup>1</sup> / <sub>8</sub> to 17 <sup>1</sup> / <sub>2</sub> -inches	19-inches
MTI-X	5-inches	6 to 15-inches	17-inches
MTI-S	3-inches	4 to 13-inches	15-inches

- (6) Any canopy which has a span differential that falls below the corresponding lower limit or exceeds the upper limit should be deemed unacceptable and will be immediately and permanently removed from service.

**NOTE**

This canopy scoring technique is intended to determine airworthiness/non-airworthiness of RAPPS canopies. In general, this technique will alert the unit level rigger to the existence of traits that have been observed in non-airworthy canopies. Armed with this information, the rigger can decide to closely monitor the performance of such canopies or remove them from service altogether. This will reduce the number of reserve activations necessitated by failure of the main to inflate.

d. Procedure number 4. Rating the Canopy's Airworthiness:

- (1) Conduct the following scoring procedure to obtain an overall rating for the canopy's airworthiness. This scoring procedure is intended only for canopies that successfully met the criteria in procedures a. through c., above.

CRITERIA		SCORE
1.	The average top surface nose permeability is:	
a.	12.0 cfm or greater	0 points (Not Airworthy)
b.	10.0 cfm to 11.99 cfm	1 point
c.	8.0 cfm to 9.99 cfm	2 points
d.	0.0 cfm to 7.99 cfm	3 points
2.	Top/bottom surface span differential is within the "Desired Range"? (procedure #3)	3 points
3.	For each cell, the top surface span is within the "Desired Range"? (procedure #2)	½ point/cell
4.	For each end cell, the top surface span is within the "Desired Range"? (procedure #2)	½ point/end cell
5.	Average top surface cell span is within the "Desired Range"? (procedure #2)	1 point
6.	Total the number of points, which the canopy has received. Locate the canopy's score on the appropriate canopy-scoring chart (Figs. 2,3) to determine its degree of airworthiness.	

CANOPY MODEL	SCORE	ACTION
MC-4 and MT1-X	11.5-9.5	Nose of canopy is dimensionally well constructed. Permeability is good. Airworthiness should not be a concern unless users report problems.
	9.0-7.5	Nose of canopy has a few dimensional problems or degraded permeability. Airworthiness should not be a concern unless users report problems. Document any anomalies in the canopy's performance.
	7.0-6.0	Nose of canopy has some of the characteristics that have been observed in non-air worthy canopies. Canopy should be fully inspected by a qualified rigger. Document any anomalies in the canopy's performance. Removal from service may be necessary.
	Less than 6.0	Nose of canopy has many of the characteristics that have been observed in non-air worthy canopies. Remove from service.

CANOPY MODEL	SCORE	ACTION
MT1-S	10.5-9.5	Nose of canopy is dimensionally well constructed. Permeability is good. Airworthiness should not be a concern unless users report problems.
	9.0-7.5	Nose of canopy has a few dimensional problems or degraded permeability. Airworthiness should not be a concern unless users report problems. Document any anomalies in the canopy's performance.
	7.0-6.0	Nose of canopy has some of the characteristics that have been observed in non-air worthy canopies. Canopy should be fully inspected by a qualified rigger. Document any anomalies in the canopy's performance. Removal from service may be necessary.
	Less than 6.0	Nose of canopy has many of the characteristics that have been observed in non-air worthy canopies. Remove from service.

NOTE

Any canopy having an average permeability reading along the top surface nose section of 12.0-cfm or greater will be removed from service.

**END OF WORK PACKAGE**

---

**UNIT MAINTENANCE**  
**MC-4 RAM AIR FREE-FALL PERSONNEL PARACHUTE SYSTEM**  
**CONVERSION (RESERVE CANOPY TO A MAIN CANOPY)**

---

**THIS TASK COVERS:**

- Conversion
- 

**INITIAL SETUP:****Tools**

Brush, Stenciling (Item 5, WP 0063 00)  
Machine, Stencil Cutting (Item 26, WP 0063 00)  
Shears (Item 39, WP 0063 00)  
Wrench,  $\frac{7}{16}$ -IN, Open End (Item 45, WP 0063 00)

**Personnel Required**

92R (10) Parachute Rigger

**Equipment Condition**

Layout on packing table or other suitable area.

**Materials/Parts**

3-Ring, Set, Riser, Main (Item 11, WP 0065 00)  
Control Line Assembly, Main, Set (Item 9, WP 0068 00)  
Ink, Marking, Parachute (Item 25/26, WP 0076 00)  
Stencil Board, Oiled (Item 31, WP 0076 00)

---

**CONVERTING RESERVE CANOPY TO MAIN CANOPY****NOTE**

Reserve canopies converted to main canopies retain their service/age life from the original date of the canopy being placed in-service/date of manufacture.

1. Using a  $\frac{7}{16}$ -inch open end wrench, disconnect the reserve canopy from the reserve risers at the connector links.
2. Perform a 100% Technical Rigger/Inspection on the canopy and suspension lines IAW WP 0011 00.
3. Perform a permeability test on the canopy IAW WP 0048 00. Canopies having an average top skin permeability value of 6.0 cubic feet per minute (CFM) or greater are not eligible for conversion to main canopies.
4. Replace the reserve control lines with main control lines IAW WP 0057 00.
5. Perform a suspension line continuity check IAW WP 0006 00.
6. Attach a set of main risers, to the connector links IAW WP 0006 00.
7. Using parachute marking ink, stencil the following near the data block: "Converted to P/N 11-1-3518-0" and date converted.

**END OF WORK PACKAGE**





**CHAPTER 4**  
**DIRECT SUPPORT MAINTENANCE INSTRUCTIONS**  
**FOR**  
**MC-4 RAM AIR FREE-FALL**  
**PERSONNEL PARACHUTE SYSTEM**



---

**DIRECT SUPPORT MAINTENANCE  
MC-4 RAM AIR FREE-FALL PERSONNEL PARACHUTE SYSTEM  
GENERAL REPAIR PROCEDURES**

---

**THIS TASK COVERS:**

- Basting and Temporary Tacking
  - Stitching and Restitching
  - Darning
  - Zig-Zag Sewing
  - Patching
- 

**INITIAL SETUP:****Equipment Condition**

Unpacked. Canopy with defects recorded. Clean.

**Personnel Required**

92R(10) Parachute Rigger

**Tools**

Specified in paragraph applicable to the item being repaired.

**Materials/ Parts**

Specified in paragraph applicable to the item being repaired.

---

NOTE

Sewing requirements will vary according to the type of item being repaired and the type of repair being made. The type of sewing machine, type of thread, the stitch range, and the stitch pattern (if applicable) required to accomplish a sewing procedure will be specified in the paragraph applicable to the item being repaired. Immediately after the accomplishment of a machine sewing procedure, trim thread ends to a point as close as possible to the material that has been sewn.

NOTE

Repair and replacement of parachute components is performed in accordance with the repair instruction in this section and in specific paragraphs applicable to the item being repaired.

**BASTING AND TEMPORARY TACKING**

Basting and temporary tacking are hand-sewing methods used to temporarily hold layers of cloth fabric together while a repair is being performed. The following is a list of procedures that apply to basting and temporary tacking actions:

1. Basting and temporary tacking should be made using thread that is of a contrasting color to the material being worked.
2. Basting and temporary tacking will be performed using a single strand of size A, nylon thread, or ticket No. 24/4 cotton thread.
3. When basting, do not tie knots at any point in the thread length. Also, the sewing should be made with two (2) stitches per inch.
4. Immediately upon completion of a repair, remove previously made basting or temporary tacking.

**STITCHING AND RESTITCHING**

Perform stitching and re-stitching as follows, refer to Tables 1 and 2.

1. Parachute canopy assemblies. The stitching and re-stitching made on parachute canopies should be accomplished with thread that is contrasting in color to the fabric being re-stitched. If contrasting color thread is not available, thread of matching color may be used, providing all other specifications are met. Straight stitching and re-stitching on parachute canopy assemblies should be locked by at least 2-inches at each end of a stitch row, when possible. Zig-Zag stitching does not require locking; however, zig-zag re-stitching should extend at least ¼-inch into undamaged stitching at each end, when possible. When re-stitching parachute canopy assemblies, stitch directly over the original stitching and follow the original stitch pattern as closely as possible.

**Table 1. Sewing Machine Code Symbols**

<b>CODE SYMBOL</b>	<b>SEWING MACHINE</b>
LD	SEWING MACHINE, INDUSTRIAL: General Sewing; 301 Stitch; Light-Duty; NSN 350-01-177-8590.
MD ZZ	SEWING MACHINE, INDUSTRIAL: Zig-Zag; 308 Stitch; Medium-Duty; NSN 3530-01-181-1421.
LD ZZ	SEWING MACHINE, INDUSTRIAL: Zig-Zag; 308 Stitch; Light-Duty; NSN 3530-01-181-1420.
HD	SEWING MACHINE, INDUSTRIAL: General Sewing; 301 Stitch; Heavy-Duty; NSN 3530-01-177-8588.
MD	SEWING MACHINE, INDUSTRIAL: General Sewing; 301 Stitch; Medium-Duty; NSN 3530-01-177-8591.
DN	SEWING MACHINE, INDUSTRIAL: Darning; Lock Stitch; NSN 3530-01-177-8589.
LHD	SEWING MACHINE, INDUSTRIAL: 301 Stitch; Light-Heavy Duty; NSN 3530-01-186-3079.
ND	SEWING MACHINE, INDUSTRIAL: 301 Stitch; Double-Needle; NSN 3530-01-182-2873.
BT	SEWING MACHINE, AUTOMATIC: Box -X; (Local purchase, Herbert Jaffe/JF PN HJ1615X1X56, Model Number 3334)
BT	SEWING MACHINE, INDUSTRIAL: Bartack, 42 stitch (Local purchase, Recommended PN HJ1466-1X42)

**Table 2. Stitching and Re-stitching Specifications**

<b>Component</b>	<b>Recommended Sewing Machine (code symbol)</b>	<b>Stitches per Inch</b>	<b>Thread Size</b>
Canopy	DN		A
Panel, Stabilizer	LD, MD, BT	7 to 11/42	E
Ribs	LD, MD	7 to 11	E
Line, Suspension	BT, ZZ	42	E
Line, Control	BT, ZZ	42	E

2. Other parachute items. Stitching and re-stitching on other parachute items constructed from cloth, canvas, and webbing should be accomplished with thread that matches the color of the original stitching, when possible. All straight stitching should be locked by backstitching at least  $\frac{1}{2}$ -inch. Re-stitching should be locked by over stitching each end of the stitch formation by  $\frac{1}{2}$ -inch. Zig-zag stitching does not require locking; however, zig-zag re-stitching should extend at least  $\frac{1}{4}$ -inch into undamaged stitching at each end, when possible. Re-stitching should be made directly over the original stitching; follow the original stitch pattern as closely as possible.

### DARNING

(Refer to Tables 1 and 2). Darning is a sewing procedure used to repair limited size holes, rips, and tears. A darning repair may be made either by hand or by sewing machine, depending upon the method preferred and the availability of equipment. However, a darning machine should be used to darn small holes and tears where fabric is missing. A darning repair will be performed using the following procedures, as appropriate:

1. Machine darning. Proceed as follows:
  - a. Using an authorized marking aid of contrasting color, mark a square around the damaged area and ensure the marking is at least  $\frac{1}{4}$ -inch back from each edge of the damaged area.
  - b. Darn the damaged area by sewing the material in a back and forth manner, using size A or E nylon thread.
  - c. Turn material and stitch back and forth across stitching made in b., above until hole or tear is completely darned.

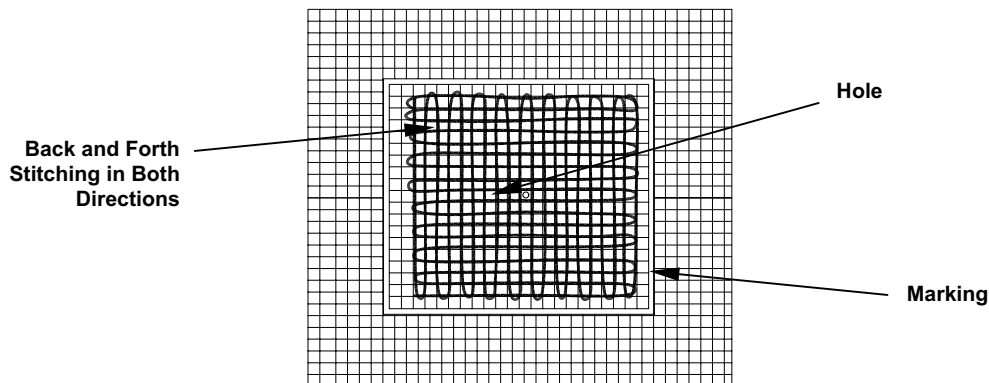

- d. If applicable, restencil informational data or identification marks using the criteria in WP 0052 00.
2. Hand darning. When repair of a hole or tear is made by hand darning, the darn should match the original weave of the damaged material as closely as possible. Hand darning is performed as follows:
    - a. Using an authorized marking aid of contrasting color, mark a square around the damaged area and ensure that the marking is at least  $\frac{1}{4}$ -inch back from each edge of the damaged area.

- b. Using darning needle and a length of size A or E nylon thread, begin darning at one corner of marked area. Working parallel with the marking, pass needle and thread back and forth through material until opposite diagonal corner of marked area is reached as shown in illustration A, below.

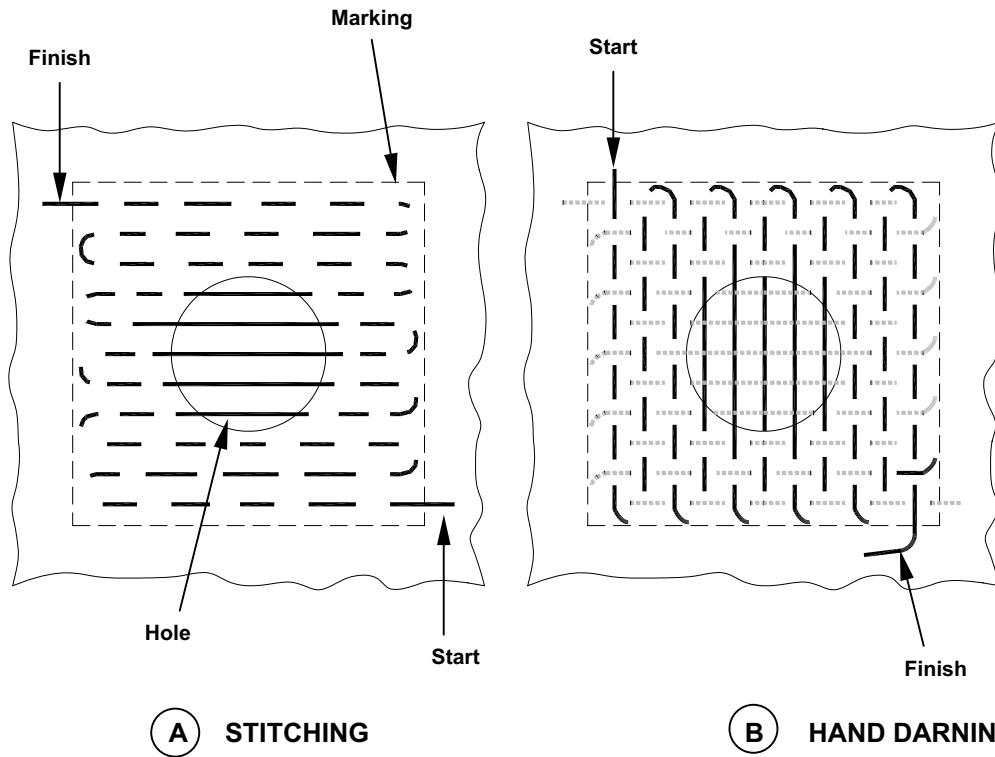

- c. Turn material and weave needle and thread back and forth across stitching made in b., above, until hole is completely darned as shown in b., above.
  - d. If applicable, restencil informational data or identification marks as outlined in WP 0052 00.
3. Zig-zag Sewing. (Refer to tables 1 and 2) Components of the MC-4, except parachute canopy, that have sustained cut or tear damage may be repaired by zig-zag sewing provided the applicable damaged area does not have any material missing and the cut or tear is straight or L-shaped. Should the damaged area be irregular shaped or have material missing, the repair will be achieved by either darning or patching, as required. A zig-zag sewing repair is accomplished using a zig-zag sewing machine as follows:
- a. Set sewing machine to maximum stitch width.
  - b. Beginning at a point 1/4-inch beyond one end of cut or tear, stitch lengthwise along damaged area to a point 1/4-inch beyond opposite end of cut or tear.



(A) STRAIGHT CUT OR TEAR STITCHING

- c. The cited stitching procedure also applies to an L-shaped cut or tear.

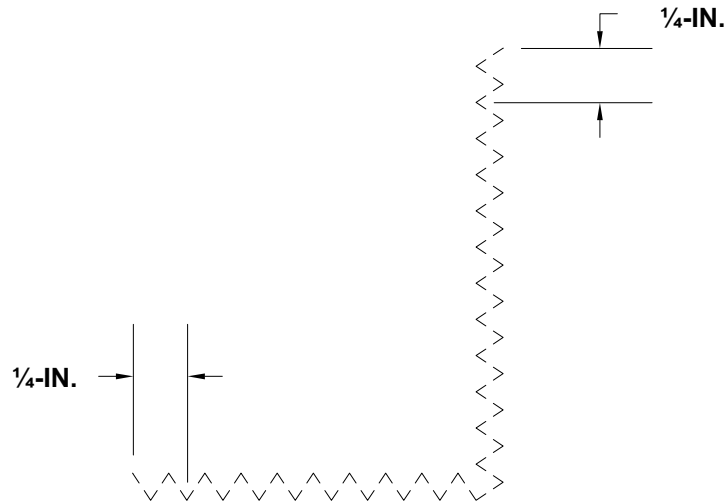

**(B) L-SHAPED CUT OR TEAR STITCHING**

- d. If applicable, restencil information data or identification marks as prescribed in WP 0052 00.
4. Patching Procedures. Patching is a procedure used to repair holes that cannot be darned.
- a. Patching limitations for the parachute canopy and container. The following is a list of patching limitations for the MC-4 parachute canopy and container.
    - (1) A patch will not be applied to a damaged area that has been previously patched.
    - (2) There will be no more than two (2) darns and three (3) patches per section, rib, or stabilizer, not to exceed 50 percent. A canopy section is defined as an area between loaded ribs (on the left and right side rigger view) and from seam to seam from nose to tail.
    - (3) A rib and a stabilizer are each considered as one (1) section. A finished basic patch shall not be closer than one-inch from a sewn seam. However, determination should be made as to the lowest economical method to be used (i.e., two (2) or more patches verses one (1) large patch or one (1) large patch verses a section replacement).

**NOTE**

Patches must be cut with their edges parallel to the warp and weft of the fabric and are to be applied with the warp and weft threads parallel to those of the material under repair.

**Canopy damage chart.** A canopy damage chart is provided for local reproduction. The canopy damage chart is used to record canopy damage and repair action.

**TOP SKIN**

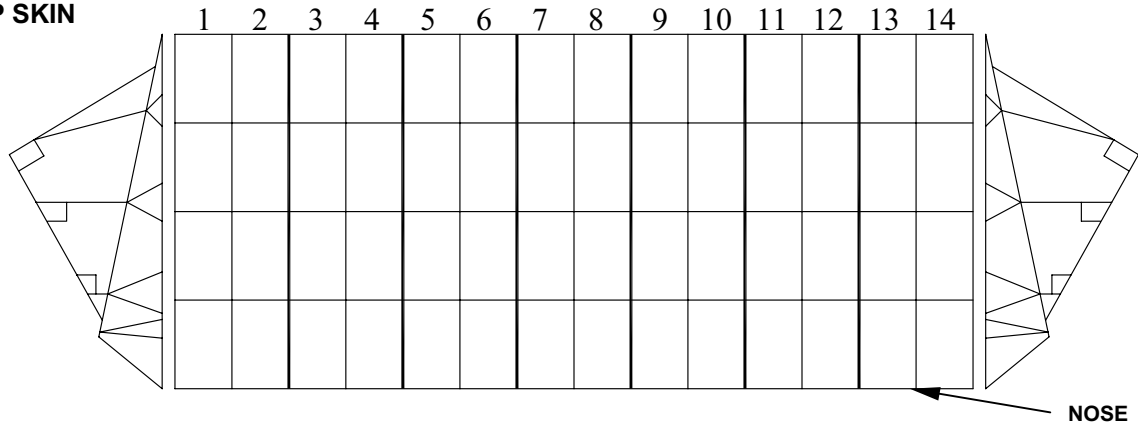

**RIBS**

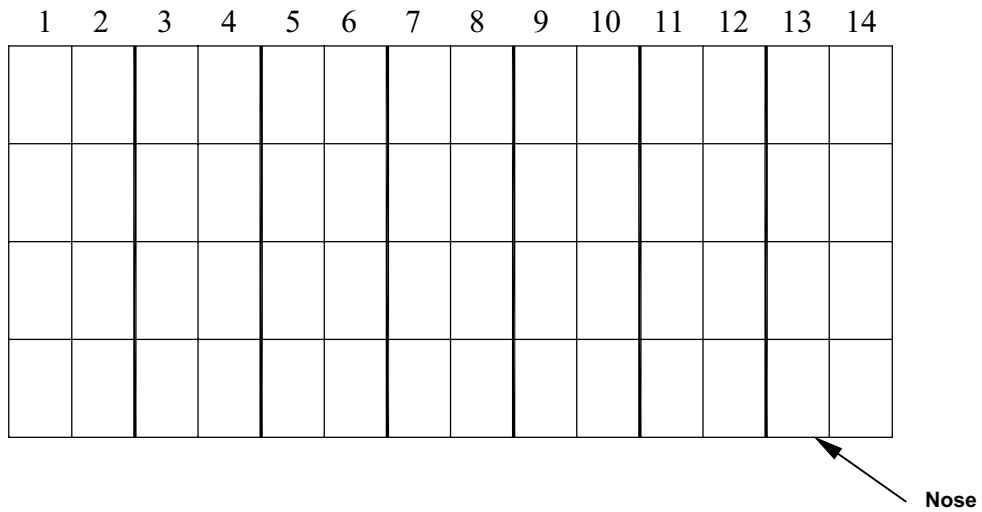

**BOTTOM SKIN**

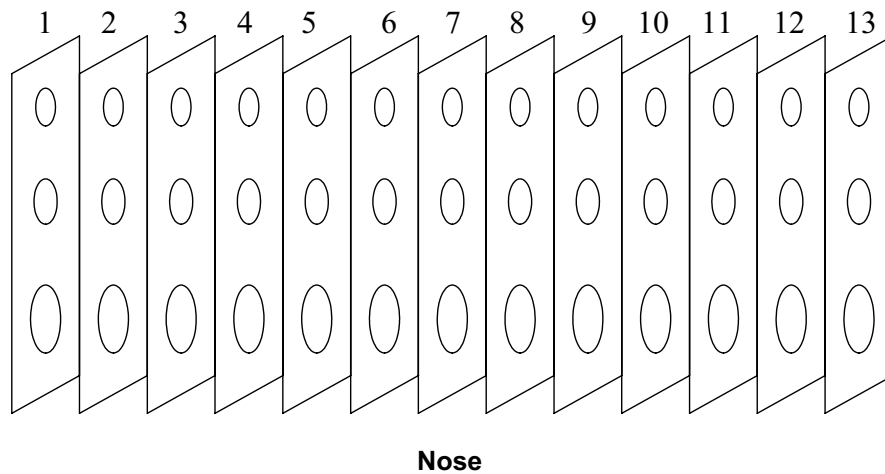



LEGEND			AMT	HRS	INSPECTION DATA	REPAIR DATA	
D	DARN	.8 X			TYPE PARACHUTE	CANOPY REPAIR	
RS	RESEW	.8 X			MC-4	NAME	DATE
BR	BURN	.4 X			SERIAL #		
RE	RESTENCIL	.4 X				LINE REPAIR	
					PIS	NAME	DATE
SP	SEWN PATCH	.8 X			WOD		
RLS	REPLACE LINE SINGLE	.8 X					
RCL	REPLACE CONTROL LINES	1.0 X			DATE INSPECTED	FINAL INSPECTION	
SLS	SEW LINE SET	1.5 X				NAME	DATE
RRH	REPLACE RIB HALF	3.0 X			INSPECTED BY		
RPS	REPLACE PANEL SINGLE	4.0 X			REPAIR HRS		
LS	REPLACE LINE SET	3.5 X					
RPD	REPLACE PANEL DOUBLE	7.0 X			INSPECTION HRS		
RRC	REPLACE RIB COMPLETE	5.0 X			3.00		
RPM	REPLACE PANEL MULTI	X			TOTAL HRS		

5. Making a basic patch. A basic patch is used to repair damaged cloth when the finished patch is no closer than 1-inch from a stitched seam or stitched tape. Should a damaged area be closer than 1-inch to the cited areas, a miscellaneous patch will be made as detailed in step 6 detailed on the following page. The basic patch is applied by sewing. The patch is applied to the inside of the canopy. The deployment bag is patched on the outside. The basic patch is shown below. Apply a basic patch as follows:

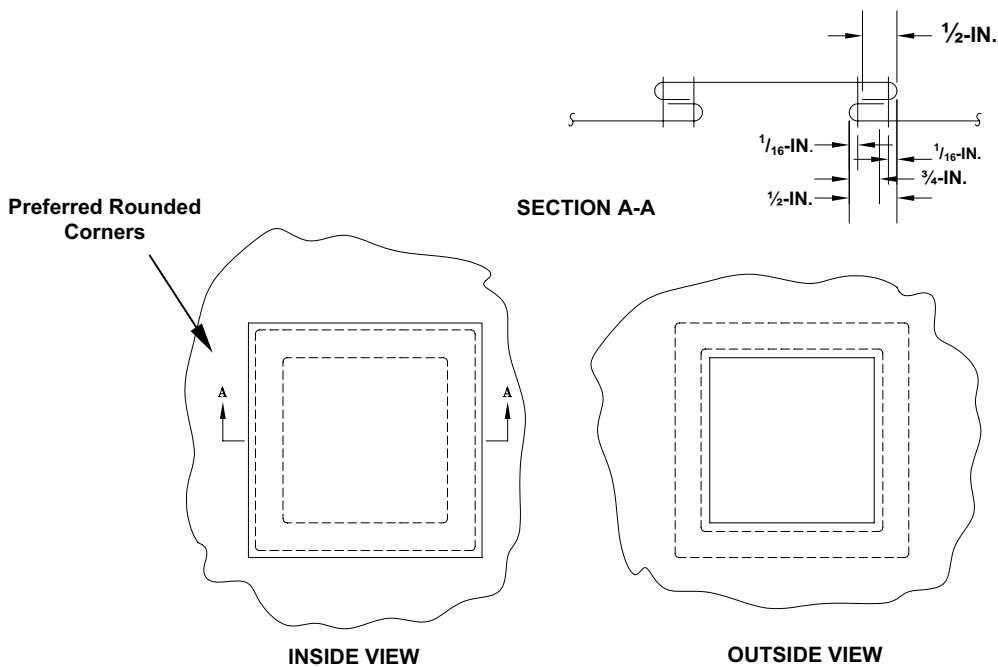

---

NOTE

A basic patch applied to the parachute canopy will be square or rectangular in shape. **ADHESIVE NYLON PARACHUTE MENDING CLOTH WILL NOT BE USED.** Ensure proper thread tension is used to prevent distortion of the canopy.

- a. Place repairable item on repair table, smooth the fabric around the damaged area, and secure item to table with push-up pins. Do not pin damaged area.
  - b. Using an authorized marking aid of contrasting color, mark a square or rectangle around area to be patched.
  - c. Cut damaged area fabric along the lines made in b., above. Further cut the fabric diagonally at each corner to allow a ½-inch fold back in the raw edges.
  - d. Make a ½-inch fold back at each raw edge. Pin and baste each foldback to complete the prepared hole. Basting is performed using procedures on page 0015 00.
  - e. Using same type material as in original construction, mark and cut a patch 2 ½-inches wider and longer than the inside measurements of prepared hole.
  - f. Center patch material over prepared hole.
  - g. Make a ½-inch fold under on each edge of patch material and pin in position. Baste patch to prepared area. Basting is performed using procedures detailed in this WP.
  - h. Remove pushpins securing canopy to repair table and secure patch by stitching, using the applicable details in the illustration above and in this WP. Make the first row of stitching completely around patch. It is not necessary for the stitch pattern to exactly follow the angles of the patch. It is preferred to round the corners of the patch, to stitch at a 45-degree angle, rather than a 90-degree angle. For corners less than or greater than 90-degrees, adjust accordingly.
  - i. Turn canopy over and make second row of stitching, ensuring that locking stitches are on opposite sides of patch. Stitching is performed in accordance with the details in this WP.
  - j. If applicable, restencil informational data according to procedures in WP 0052 00.
6. Applying miscellaneous canopy patch. A miscellaneous canopy patch, which may be irregularly shaped, is used to repair damaged canopy material when the location of the damaged area requires the patch to extend into or over a seam or a reinforced seam. Ascertain the type of patch required for the canopy using the details in the illustrations on the following page. A canopy section that cannot be patched with a basic patch as outlined in step 5., above, is patched with a miscellaneous patch. Apply a miscellaneous patch to a section as follows (refer to following page):

INSIDE VIEW

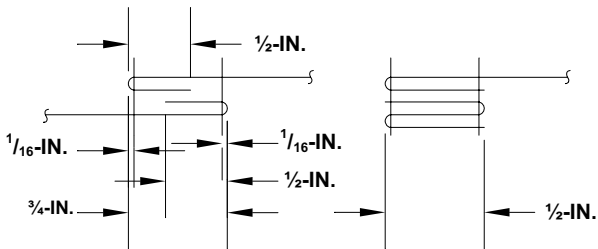
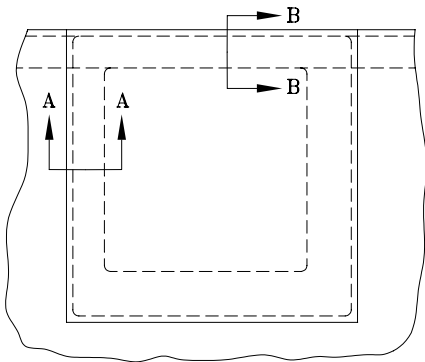

SECTION A-A

SECTION B-B

INSIDE VIEW

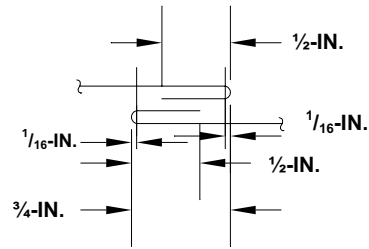
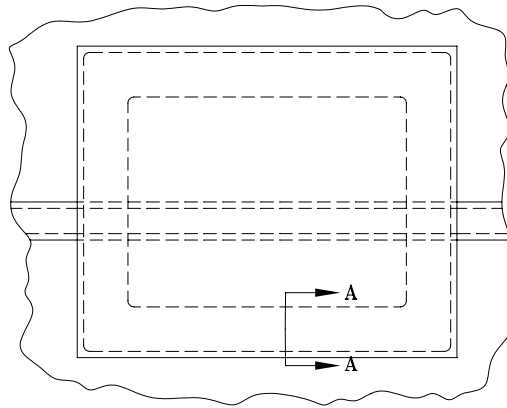

SECTION A-A

A. OUTSIDE VIEW

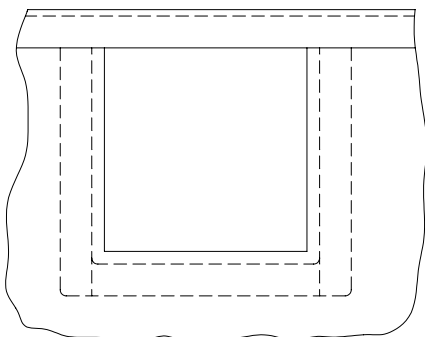

B. OUTSIDE VIEW

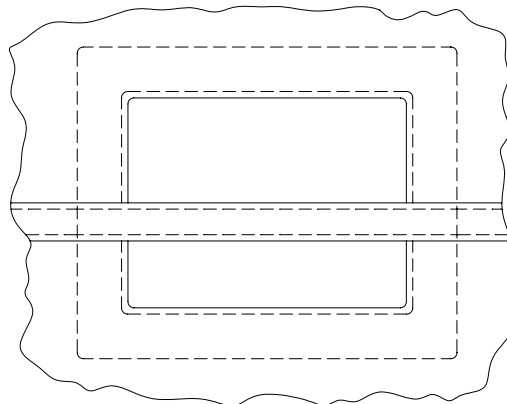

**NOTE:**  
FOR TWO OUTMOST RIBS, THE PATCH WILL BE APPLIED OVER THE REINFORCING TAPE.

- A. RECTANGULAR PATCH AT REINFORCING TAPE OF LEADING EDGE (UPPER AND LOWER) FOR DAMAGE NOT CLOSER THAN 2-INCHES TO RIB SEAMS.

**NOTE:** FOR AN OUTSIDE RIB OVER A REINFORCING TAPE,

- 1. REMOVE STITCHING FROM REINFORCING TAPE.
- 2. APPLY A BASIC PATCH.
- 3. RE-STITCH THE REINFORCING TAPE.
- B. RECTANGULAR PATCH CROSSING A REINFORCING TAPE.

---

NOTE

**ADHESIVE NYLON PARACHUTE MENDING CLOTH WILL NOT BE USED** in the construction or application of a miscellaneous canopy patch.

- a. Place canopy inside out on a repair table, smooth fabric around damaged area, and secure damaged section to table with pushup pins. Do not pin damaged area of section.
- b. As required, cut applicable stitching to remove or lay aside items that may interfere with patching process.
- c. Using an authorized marking aid of contrasting color, mark damaged area. Mark the ½-inch from any adjacent seam or reinforced seam, except where the width of the foldback is limited by the width of the reinforced seam.
- d. Prepare damaged area hole by cutting along marks made in step c., above. Also make a diagonal cut at each corner of formed hole to permit a foldback of each raw edge.
- e. To complete hole preparation, make a ½-inch fold back of each raw edge. Pin and baste each edge foldback using procedures detailed in this WP.
- f. Using same type material as in original canopy construction, mark and cut a patch 2 ½-inches wider and longer than inside measurements of prepared hole.
- g. Center patch material over prepared hole.
- h. Make a ½-inch fold under on each edge of patch material and pin patch material in position. Baste patch to prepared area. Basting is performed using procedures detailed in this WP.
- i. Remove pushpins securing canopy to repair table and secure patch by stitching according to the details in the illustrations above and below, using stitching specifics outlined in tables 1 and 2.

INSIDE VIEW

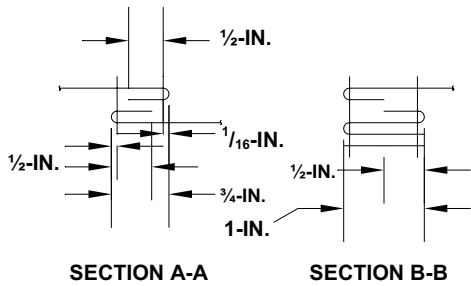
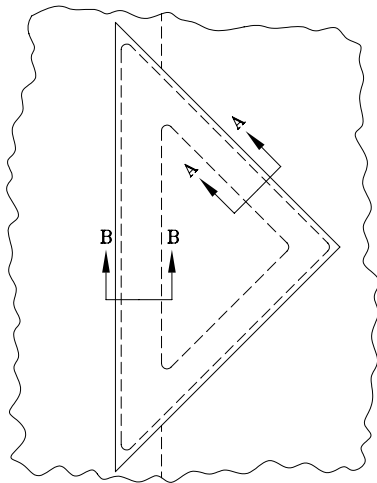

SECTION A-A

SECTION B-B

INSIDE VIEW

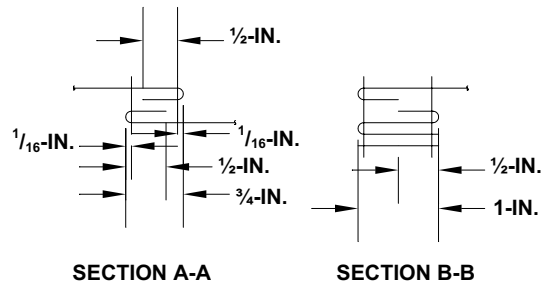
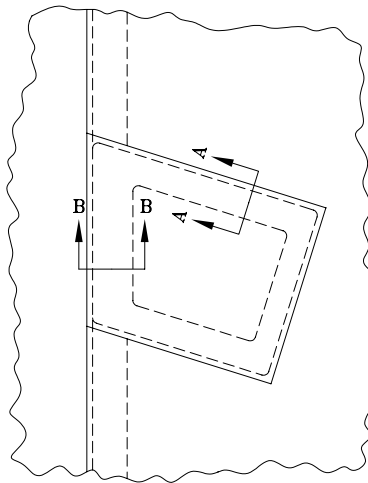

SECTION A-A

SECTION B-B

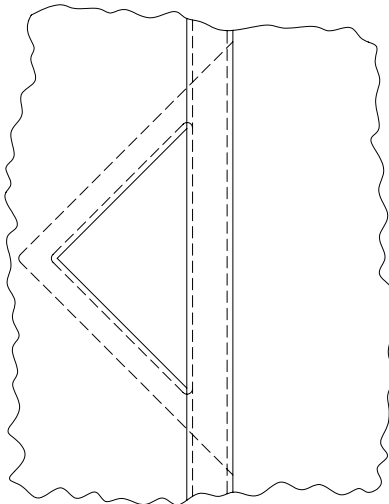

C. OUTSIDE VIEW

C. TRIANGULAR PATCH AT FRONT LEADING EDGE OF RIBS.

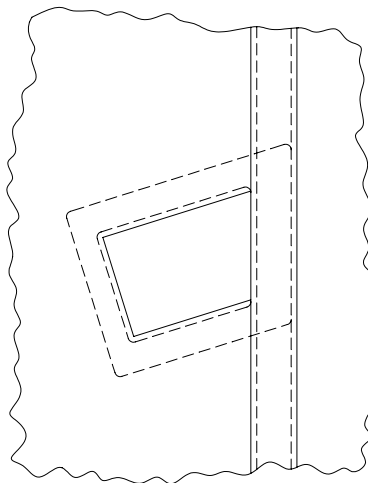

D. OUTSIDE VIEW

D. FOUR-SIDED PATCH AT FORWARD LEADING EDGE OF RIBS.

- j. Make the first row of stitching completely around the edges of the patch. Turn canopy right side out and make a second row of stitching, ensuring that locking stitches are on opposite sides of patch. Stitching is performed in accordance with this WP.
- k. Reposition canopy items removed or laid aside in step b., above, in the original location and secure each item to canopy by restitching according to original construction details and the procedures detailed in this WP.
- l. If applicable, restencil informational data according to procedures in WP 0052 00.

**END OF WORK PACKAGE**

---

**DIRECT SUPPORT MAINTENANCE**  
**MC-4 RAM AIR FREE-FALL PERSONNEL PARACHUTE SYSTEM**  
**SEARING AND WAXING**

---

**THIS TASK COVERS:**

- Searing
  - Waxing
- 

**INITIAL SETUP:****Tools**

Knife, Hot Metal (Item 24, WP 0063 00)  
Pot, Melting, Electric (Item 34, WP 0063 00)

**Personnel Required**

92R (10) Parachute Rigger

**Materials/Parts**

Beeswax (Item 5, WP 0076 00)  
Wax, Paraffin (Item 46, WP 0076 00)

**Equipment Condition**

Unpacked

---

---

**CAUTION**

---

Cotton tape, webbing, or cord will not be seared.

---

**NOTE**

---

Fabric materials such as cord, tape, and webbing that is cut for use in the maintenance of the MC-4 parachute will normally be heat-seared or dipped in a melted wax mixture, as applicable, to prevent the material from fraying or unraveling. However, in some instances the preparation of the material may not be necessary and will be specified accordingly.

**SEARING**

The cut ends of nylon tape, webbing, and cord lengths may be prepared by heat-searing, which is performed by pressing the raw end of the material against a hot metal surface (knife) until the nylon has melted sufficiently.

---

**CAUTION**

---

Avoid forming a sharp edge or lumped effect on the melted end.  
Sharp edges may cut other components

**WAXING**

Fraying or unraveling of cotton or nylon tape, webbing, and cord length ends may be prevented by dipping ½-inch of the raw end of the material into a thoroughly melted mixture of half beeswax and half paraffin in an electric melting pot. The wax temperature should be substantial enough to ensure the wax completely penetrates the material rather than just coating the exterior fabric.

**END OF WORK PACKAGE**





---

**DIRECT SUPPORT MAINTENANCE  
MC-4 RAM AIR FREE-FALL PERSONNEL PARACHUTE SYSTEM  
MARKING AND RESTENCILING**

---

**THIS TASK COVERS:**

- Marking
  - Restenciling
- 

**INITIAL SETUP:****Tools**

Brush, Stenciling (Item 5, WP 0063 00)  
Machine, Stencil Cutting (Item 26, WP 0063 00)

**Materials/Parts**

Ink, Marking, Parachute (Item 25/26, WP 0076 00)  
Marker, Felt Tip, Permanent, Black (Item 28, WP 0076 00)  
Pen, Ball Point (Item 29, WP 0076 00)  
Stencil Board, Oiled (Item 31, WP 0076 00)

---

**Personnel Required**

92R (10) Parachute Rigger

**Equipment Condition**

Lay out on packing table or other  
Suitable area.

---

**NOTE**

---

Stenciling should be used whenever possible. A ballpoint pen or permanent felt tip marker should be used only where stenciling is not possible, or when stenciling devices are not available. Any type ball point pen using black or blue ink may be used for marking on labels only.

Original stenciled data or marking that becomes faded, illegible, obliterated, or are removed as a result of performing a repair procedure will be remarked with a ballpoint pen, felt tip marker, or re-stenciled. All marking or re-stenciling will be done on or as near as possible to the original location and should conform to the original lettering type and size.

**MARKING**

Using marking devices such as ballpoint pen or permanent felt tip marker, mark on, or as near as possible to, original location and conform to original lettering type and size.

**RESTENCILING**

Proceed as follows:

1. Cut oiled stencil board to original lettering type and size of data to be restenciled.
2. Place cut stencil board over, or as near as possible to, original marking to be restenciled.
3. Place additional sheet or stencilboard beneath area to be re-stenciled to prevent marking ink from penetrating to other areas.
4. Hold stencilboard in place and, using stenciling brush filled with parachute marking ink, restencil original marking.

**END OF WORK PACKAGE**



**DIRECT SUPPORT MAINTENANCE**  
**MC-4 RAM AIR FREE-FALL PERSONNEL PARACHUTE SYSTEM**  
**SUSPENSION LINES (LINES 4A/B AND 5 A/B ONLY)**

**THIS TASK COVERS:**

- Replace

**INITIAL SETUP:**

**Tools**

Sewing Machine, Bartack (Table 1, WP 0050 00)  
 Shears (Item 39, WP 0063 00)  
 Tape Measure (Item 42, WP 0063 00)

**Materials/Parts**

Cord, Dacron, 600-Pound, Type I (Item 12, WP 0076 00)  
 Thread, Nylon, Size E (Item 43/44, WP 0076 00)

**Personnel Required**

92R (10) Parachute Rigger

**Equipment Condition**

Lay out on packing table or other suitable area.

**Follow-Up Procedure**

Continuity check and canopy trim check (WPs 0005 00 and 0006 00).

**REPLACE**

**NOTE**

This procedure applies only to lines 4 A/B and 5 A/B which in each case are one continuous line, running from the forward center cell (A lines) of the canopy to the inboard side of the front connector links, then back to the forward center cell (B lines) of the canopy.

1. Find the approximate mid-point of replacement line. Position midpoint at inboard (barrel side) of connector link. Secure line to connector link with bartack stitch. Bartack begins  $\frac{3}{4} \pm \frac{1}{8}$ -inch from end of loop and is  $\frac{5}{8}$ -inch long by  $\frac{1}{8}$ -inch wide.

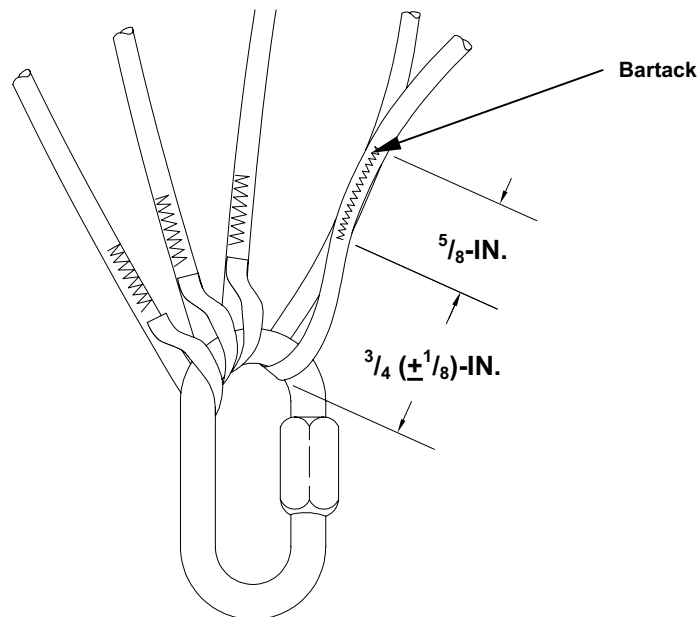

- Route both free ends of line through front slider grommet to proper canopy attachment points. Tie free end of line to attachment loop with a French locking knot. Adjust line to proper trim using other lines in the group as reference.

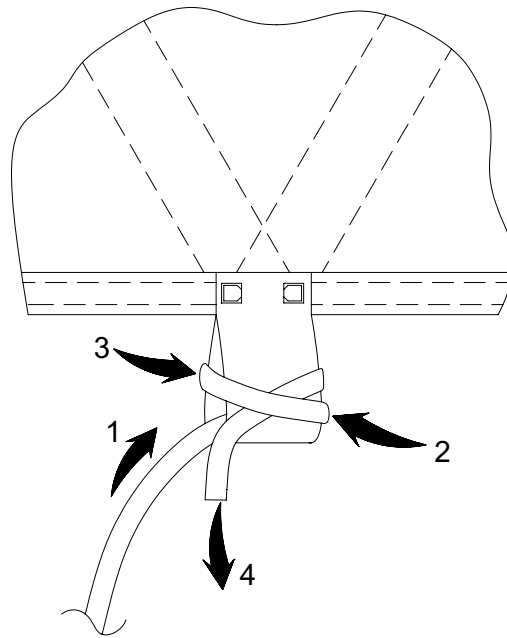

- When adjusted, lay free end of line on top of main line and secure with  $\frac{5}{8}$ -inch by  $\frac{1}{8}$ -inch bartack placed as close to knot as possible. Trim line  $\frac{1}{16}$ -inch from bartack.

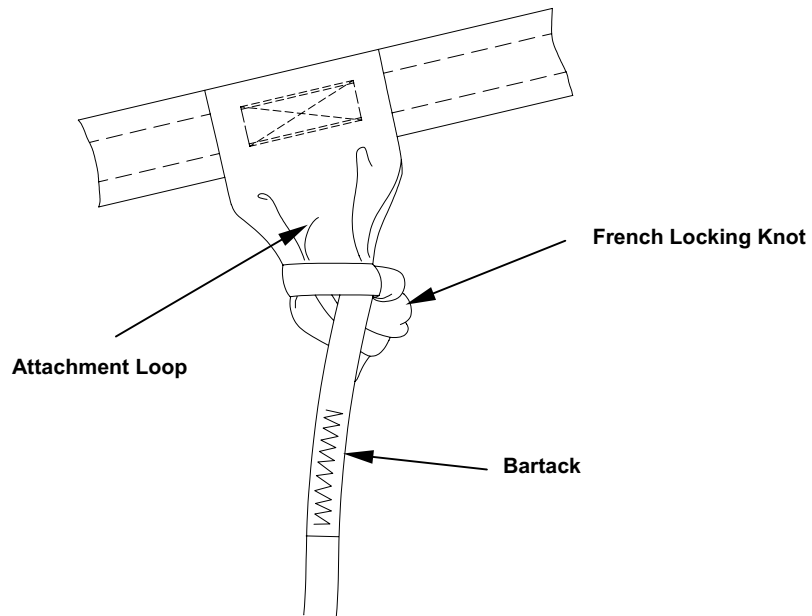

- Perform continuity check IAW WP 0004 00.

**END OF WORK PACKAGE**

**DIRECT SUPPORT MAINTENANCE  
MC-4 RAM AIR FREE-FALL PERSONNEL PARACHUTE SYSTEM  
SUSPENSION LINE SETS (PREFERRED METHOD)**

**THIS TASK COVERS:**

- Replace

**INITIAL SETUP:**

**Tools**

Needle, Tacking (Item 29, WP 0063 00)  
Sewing Machine, Bartack (Table 1, WP 0050 00)  
Shears (Item 39, WP 0063 00)  
Wrench, <sup>7</sup>/<sub>16</sub>-IN., Open-End (Item 45, WP 0063 00)

**Personnel Required**

92R (10) Parachute Rigger

**Equipment Condition**

Canopy in proper layout.

**Materials/Parts**

Suspension Line Set, Main/Reserve (Item 5, WP 0068 00/WP 0069 00)  
Tape, Lacing and Tying (Item 33, WP 0076 00)  
Thread, Nylon, Size E (Item 43/44, WP 0076 00)

**Follow-Up Procedure**

Continuity check and canopy check (WPs 0005 00 and 0006 00).

**REPLACE**

**NOTE**

Replacement of suspension lines as a set is the preferred method. If suspension line sets are not available, replacement of individual lines from bulk material is authorized. Refer to WP 0055 00.

**NOTE**

When replacing suspension lines, the overall base A-Line measurement will be 14-feet, 6-inches (± 2-inches).

1. Replace suspension lines as follows:

- a. With canopy in proper layout, place replacement connector link adjacent to connector link with damaged line(s).
- b. Using old lines as a guide, route replacement lines through proper slider grommet to appropriate canopy attachment points and mark lines.
- c. Cut and remove old lines from attachment loops. Route replacement lines through attachment loops, and with mark centered in loop, secure with a French locking knot.

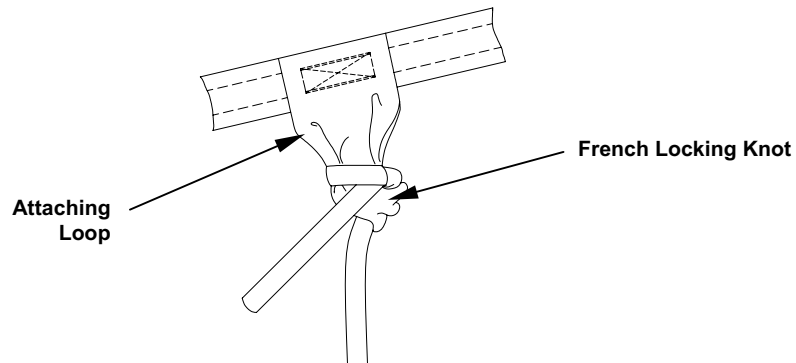

- d. Cut and remove tacking on risers below connector links.

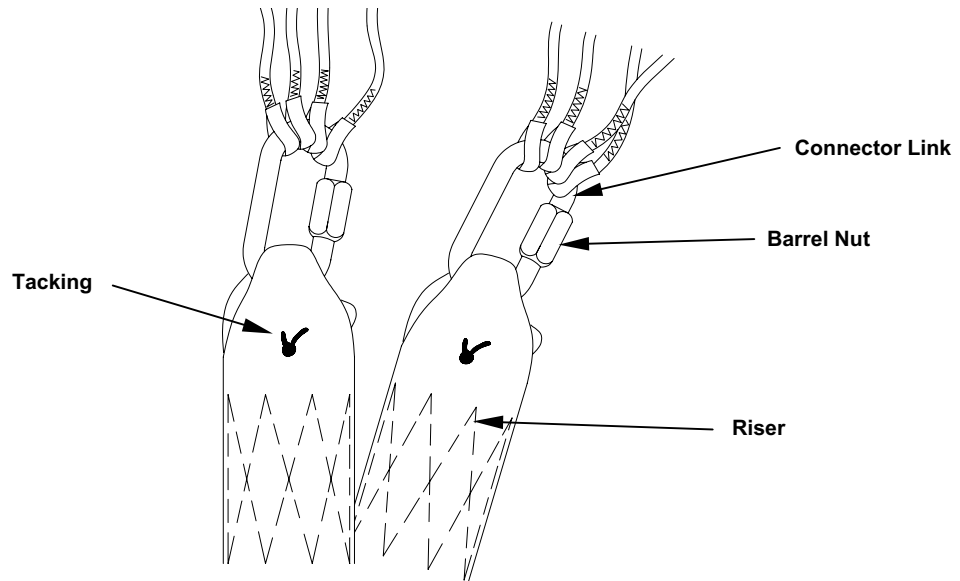

- e. Loosen barrel nuts on connector links with  $\frac{7}{16}$ -inch open-end wrench.
- f. Remove connector links from risers and discard old lines.
- g. Connect connector links to risers. Connector link barrel nuts must face inboard and tighten upward.
- h. Using  $\frac{7}{16}$ -inch open-end wrench, tighten barrel nut on connector links  $\frac{1}{4}$  turn past hand tight.
- i. Hand-tack each riser at connector link with one turn double nylon lacing tape.

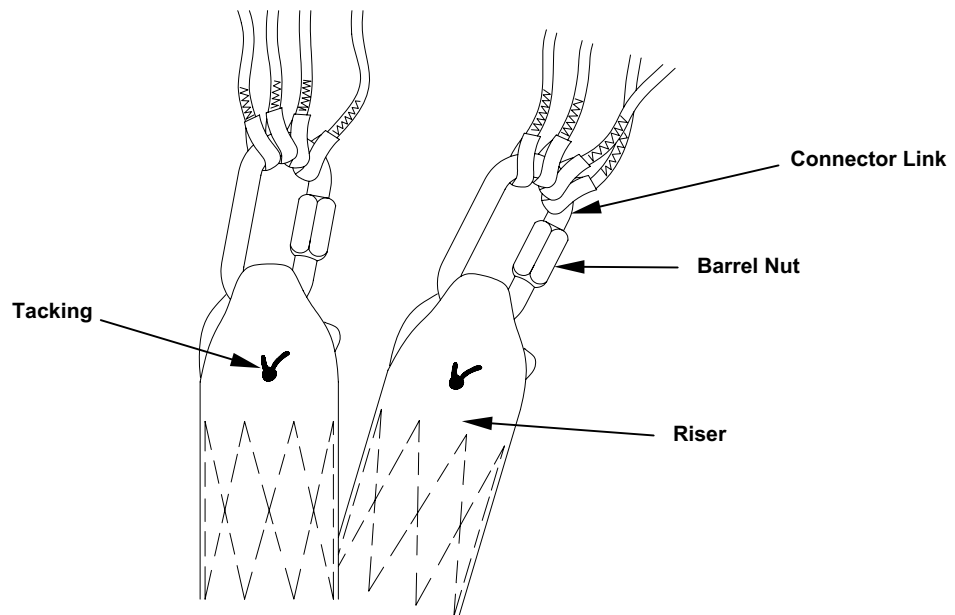

- j. Perform a canopy trim check in accordance with WP 0005 00 or WP 0006 00, as applicable. Adjust lengths of suspension lines at French locking knots to achieve required results.
- k. When adjusted, lay free end of line on top of main line and secure with a  $\frac{5}{8}$ -inch by  $\frac{1}{8}$ -inch bartack placed as close to the knot as possible. Trim line  $\frac{1}{16}$ -inch from bartack.

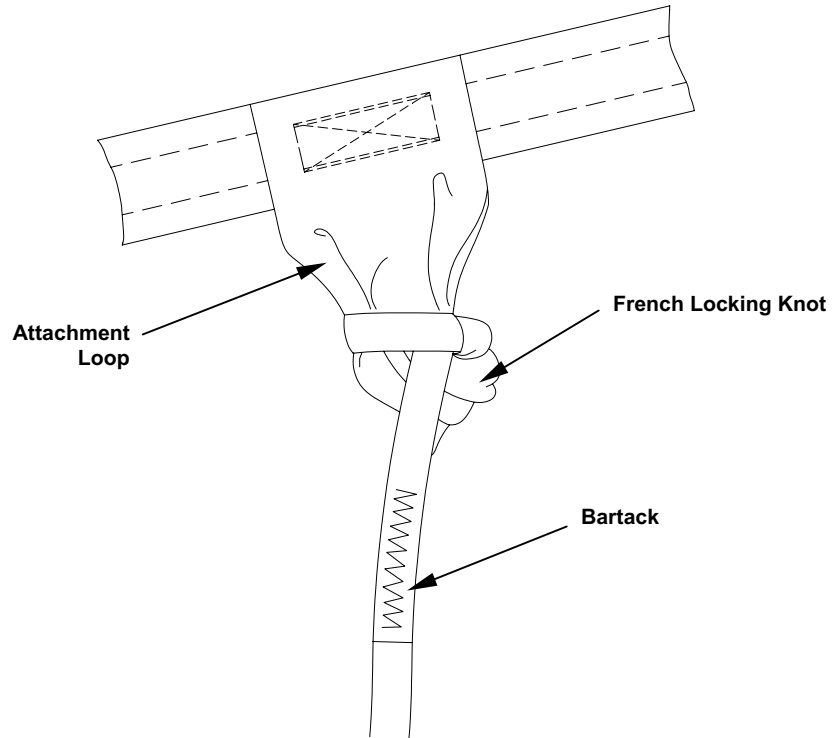

- l. Perform follow-up procedure IAW WPs 0005 00 and 0006 00.

**END OF WORK PACKAGE**





**DIRECT SUPPORT MAINTENANCE  
MC-4 RAM AIR FREE-FALL PERSONNEL PARACHUTE SYSTEM  
SUSPENSION LINES/CASCADE LINES (ALTERNATE METHOD)**

**THIS TASK COVERS:**

- Replace

**INITIAL SETUP:**

**Tools**

- Finger Trap Tool (Item 16, WP 0063 00)
- Sewing Machine, Bartack (Table 1, WP 0050 00)
- Shears (Item 39, WP 0063 00)
- Tape Measure (Item 42, WP 0063 00)

**Personnel Required**

92R (10) Parachute Rigger

**Follow-Up Procedure**

Continuity check and canopy trim check (WPs 0005 00 and 0006 00).

**Materials/Parts**

- Cord, Dacron, 600-Pound, Type I (Item 12, WP 0076 00)
- Thread, Nylon, Size E (Item 43/44, WP 0076 00)

**Equipment Condition**

Lay out on packing table or other suitable area.

**REPLACE**

**NOTE**

This procedure is authorized only if pre-manufactured suspension line sets are unavailable.

This procedure applies to all lines except lines 4 A/B and 5 A/B lines. To replace lines 4 A/B and 5 A/B, refer to WP 0054 00.

**NOTE**

When replacing suspension lines, the overall base A-Line measurement will be 14-feet, 6-inches ( $\pm 2$ -inches).

1. Main Suspension Lines. Replace main suspension lines as follows:

- a. Trim end of replacement line with scissors and taper approximately 1/4-inch. Route line through connector link and finger-trap 3-inches of line forming a 3/4  $\pm 1/8$ -inch loop at connector link.

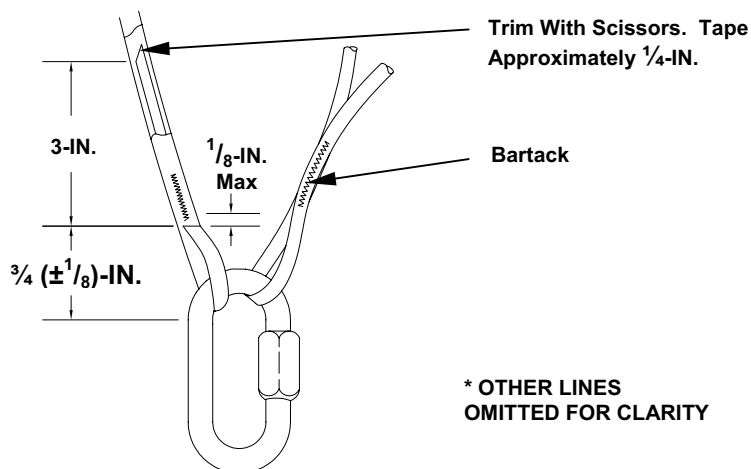

- b. Secure line with a  $\frac{5}{8}$ -inch by  $\frac{1}{8}$ -inch bartack beginning  $\frac{1}{8}$ -inch from loop.
- c. Route free end of line through proper slider grommet to appropriate canopy attachment point. Tie free end of line to attachment loop with a French locking knot. Adjust line to the proper trim using the other lines in the group as reference.

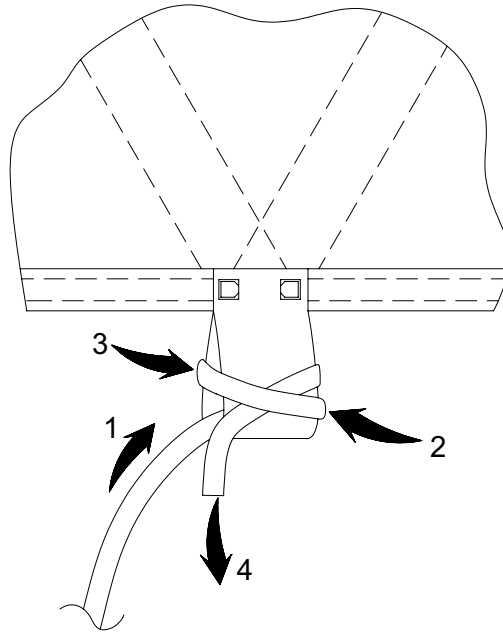

- d. When adjusted, lay free end of line on top of main line and secure with a  $\frac{5}{8}$ -inch by  $\frac{1}{8}$ -inch bartack placed as close to knot as possible. Trim line  $\frac{1}{16}$ -inch from bartack.

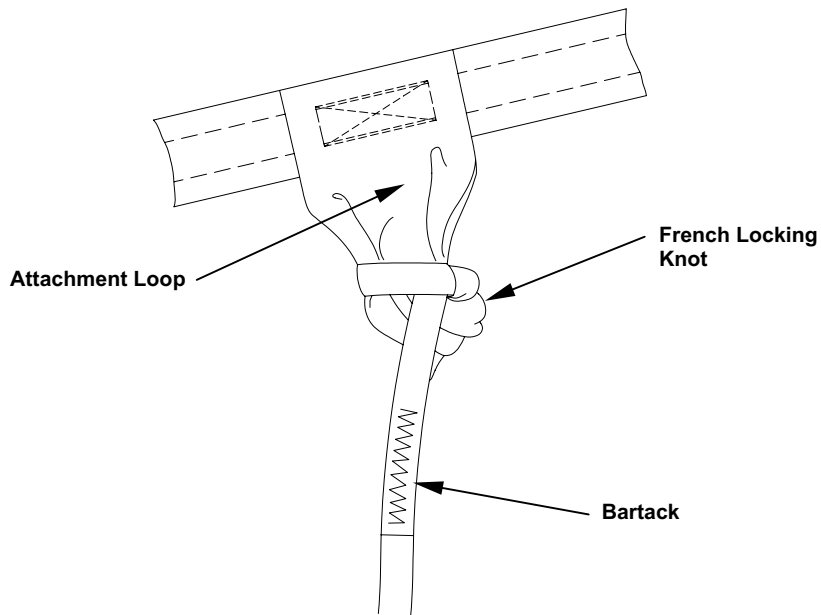

2. Cascaded Suspension Lines. Replace cascaded suspension lines as follows:

- a. Lay replacement cascaded line on top of main line in same location as old line. Secure cascaded line to main line with two  $\frac{5}{8}$ -inch by  $\frac{1}{8}$ -inch bartack, located  $\frac{1}{8}$ -inch apart. Sear cut cascaded line  $\frac{1}{16}$ -inch from end of bartack.

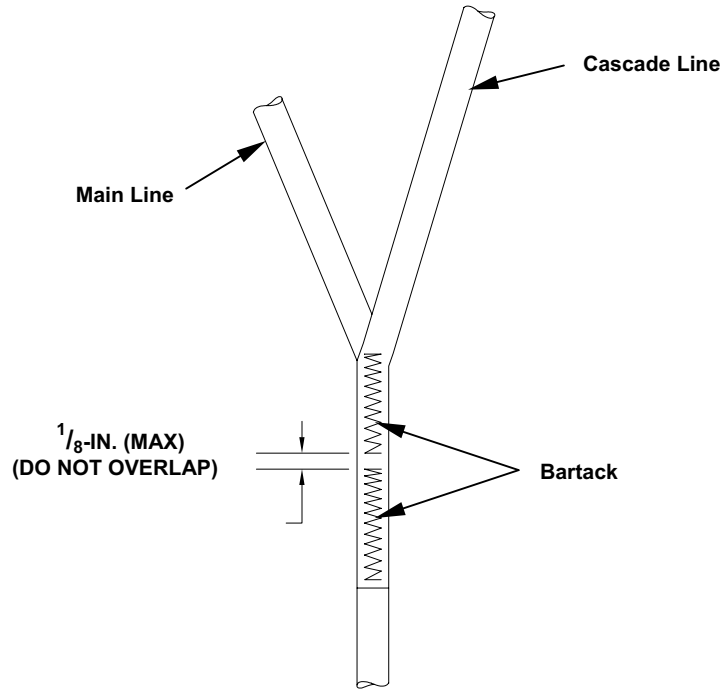

- b. Tie free end of cascaded line to canopy attachment loop with a French locking knot. Adjust line to proper trim using other lines in-group as reference.
- c. When adjusted, lay free end of line on top of main line and secure with a  $\frac{5}{8}$ -inch by  $\frac{1}{8}$ -inch bartack placed as close to knot as possible. Trim line  $\frac{1}{16}$ -inch from bartack.

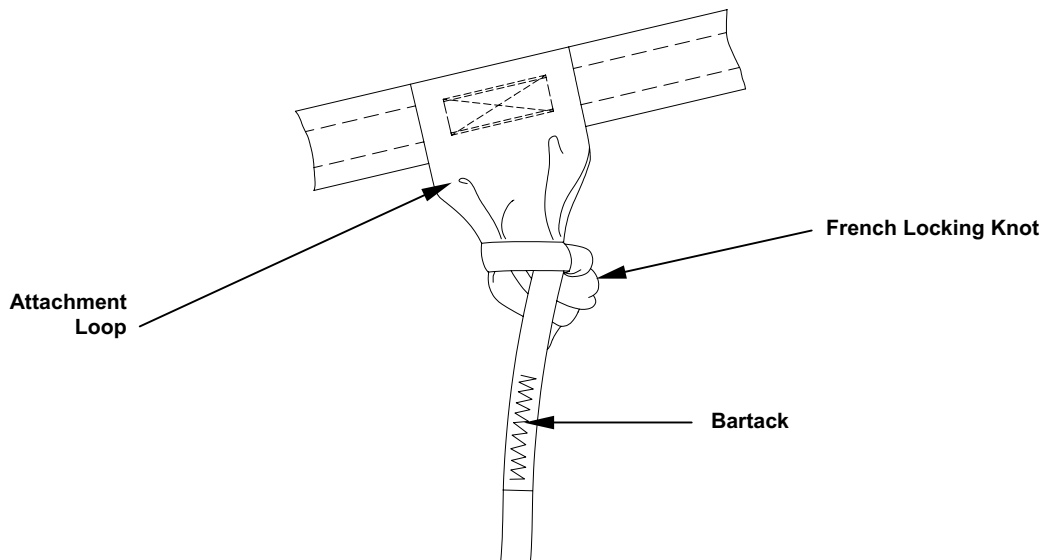

- d. Perform continuity check IAW WPs 0005 00 and 0006 00.

**END OF WORK PACKAGE**

---

**DIRECT SUPPORT MAINTENANCE**  
**MC-4 RAM AIR FREE-FALL PERSONNEL PARACHUTE SYSTEM**  
**SUSPENSION LINE ATTACHING LOOP**

---

**THIS TASK COVERS:**

- Replace
- 

**INITIAL SETUP:**

**Tools**

Sewing Machine, Double Box-X (Table 1, WP 0050 00)  
 Stitch Removal Tool (Item 39, WP 0063 00)

**Materials/Parts**

Aid, Marking (Item 1/2, WP 0076 00)  
 Tape, Nylon, 1-Inch Wide (Item 34, WP 0076 00)  
 Thread, Nylon, Size E (Item 43/44, WP 0076 00)

**Personnel Required**

92R (10) Parachute Rigger

**Equipment Condition**

Lay out on packing table or other suitable area.

---

**REPLACE**

The suspension line attaching loop may need to be replaced in conjunction with a repair to the canopy. Remove and reattach the suspension line attaching loop as follows:

1. Using an authorized marking aid of contrasting color, mark the original location of the suspension line attaching loop using the adjoining loaded rib as a guide to determine where to reattach the suspension line attaching loop.
2. Using the stitch removal tool, carefully remove the suspension line attachment loop from the canopy.
3. Depending on the location of the suspension line attaching loop, the cut length of the material will vary as follows:
  - a. Suspension line attaching loops on the canopy nose are two (2) 3 ½-inch pieces.
  - b. Suspension line attaching loops on the canopy tail are one (1) 3-inch piece.

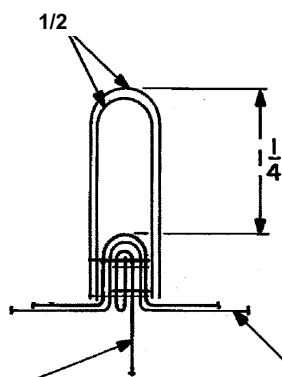

**Canopy Nose Suspension Line Attaching Loops (2 plies)**

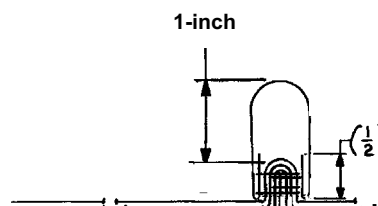

**Canopy Tail Suspension Line Attaching Loops**

**NOTE:** Fold under optional, if fold under is used, cut length is 4-inches.

- c. Suspension line attaching loops sewn within the center of the canopy are one (1) 4 ½-inch piece.

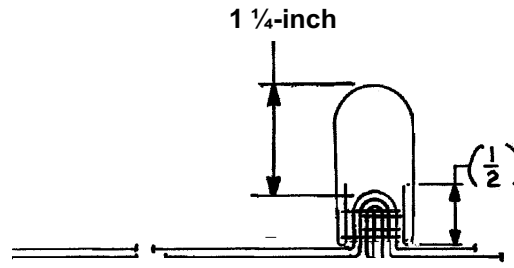

- 4. Repair canopy damage as outlined in the applicable WP.
- 5. Depending on the location of the suspension line attaching loop, cut the appropriate length of tape, textile, 1-Inch wide material and sear both ends.
- 6. Using a double box-X pattern sewing machine, size E nylon thread and 56 stitches per inch, reattach the suspension line attaching loop to the original location as previously marked.

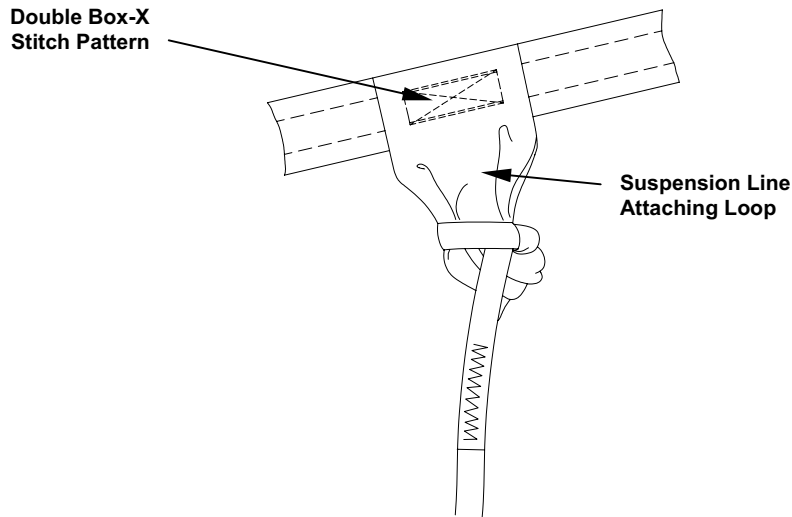

- a. Perform continuity check IAW WP 0005 00 or WP 0006 00.

**END OF WORK PACKAGE**

---

**DIRECT SUPPORT MAINTENANCE**  
**MC-4 RAM AIR FREE-FALL PERSONNEL PARACHUTE SYSTEM**  
**CONTROL LINES**

---

**THIS TASK COVERS:**

- Replace
- 

**INITIAL SETUP:****Tools**

Sewing Machine, Bartack (Table 1, WP 0050 00)  
Shears (Item 39, WP 0063 00)

**Materials/Parts**

Control Line Set, Main (Item 9, WP 0068 00)  
Control Line Set, Reserve (Item 9, WP 0069 00)  
Thread, Nylon, Size E (Item 43/44, WP 0076 00)

**Personnel Required**

92R (10) Parachute Rigger

**Follow-Up Procedure**

WP 0005 00; WP 0006 00

**Equipment Condition**

Lay out on packing table or other suitable area.

---

**REPLACE****NOTE**

When replacing control lines, both control lines will be replaced.

1. Lay out upper control lines at their corresponding attachment loops. Route lines through attachment loops, adjust in accordance with WP 0005 00 or WP 0006 00 as applicable and secure with a French locking knot.

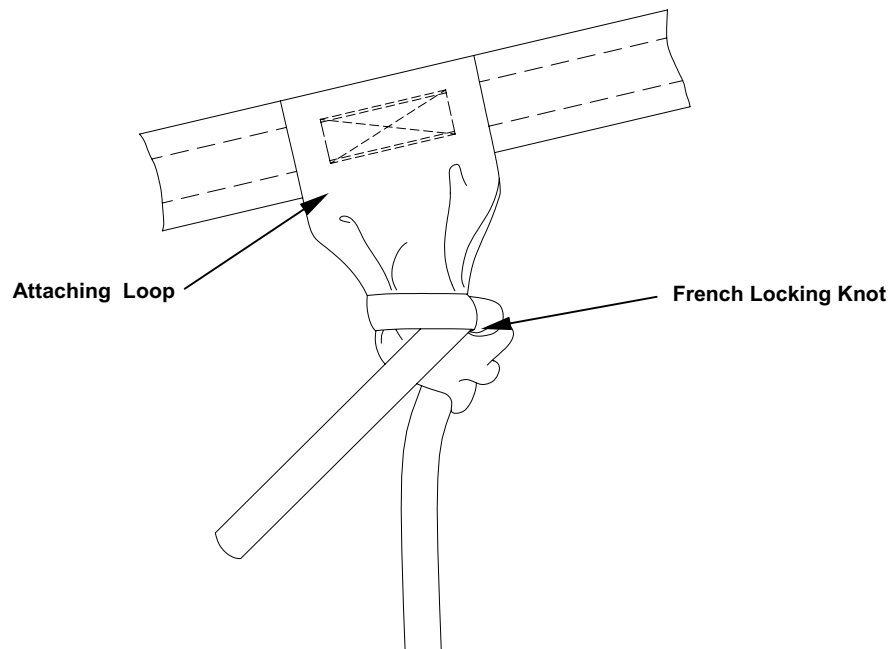

2. Apply equal tension to all lines and adjust trim.
3. When adjusted, lay free ends of lines on top of main lines and secure with a  $\frac{5}{8}$ -inch by  $\frac{1}{8}$ -inch bartack placed as close to knot as possible. Trim lines  $\frac{1}{16}$ -inch from bartack.

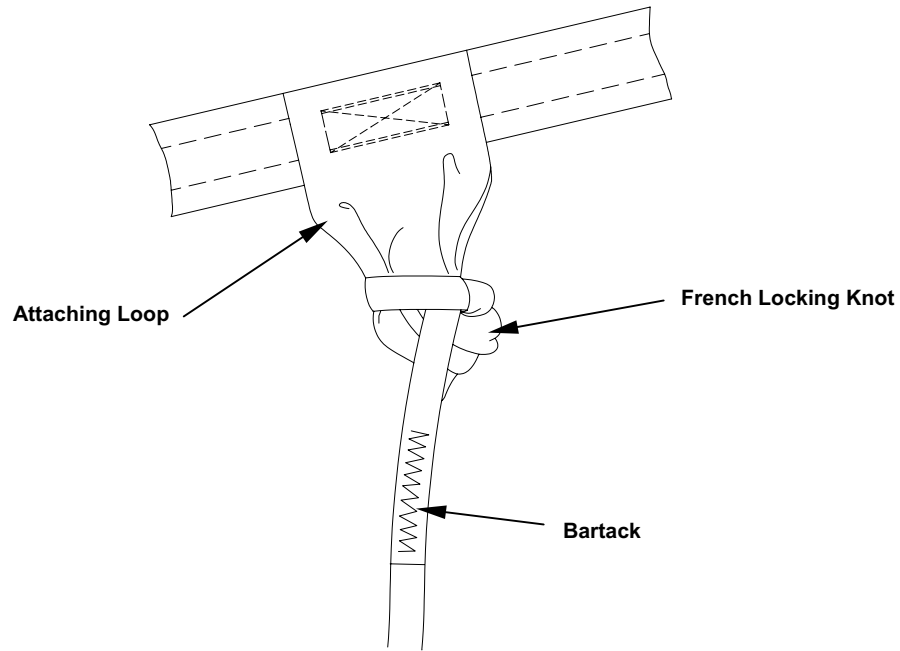

4. Perform follow-up procedure IAW WPs 0005 00 and 0006 00.

**END OF WORK PACKAGE**



---

**DIRECT SUPPORT MAINTENANCE**  
**MC-4 RAM AIR FREE-FALL PERSONNEL PARACHUTE SYSTEM**  
**CANOPY RIB**

---

**THIS TASK COVERS:**

- Replace
- 

**INITIAL SETUP:**

**Tools**

Needle, Tacking (Item 29, WP 0063 00)  
 Sewing Machine, Light-Duty (Table 1, WP 0050 00)  
 Sewing Machine, Double Needle w/Puller ( $\frac{3}{8}$  gauge)  
 (Table 1, WP 0050 00)  
 Shears (Item 39, WP 0063 00)  
 Stitch Removal Tool (Item 40, WP 0063 00)  
 Tape Measure (Item 42, WP 0063 00)

**Equipment Condition**

Layout on packing table or other suitable area.

**Personnel Required**

92R (10) Parachute Rigger

**Materials/Parts**

Rib, Loaded/Unloaded (WP 0068 00/WP 0069 00) As Applicable  
 Thread, Nylon, Size E (Item 43/44, WP 0076 00)

---

**REPLACE (WHOLE RIB)**

1. Cut stitching to open tail section approximately 12-inches on each side of the damaged rib.
2. Premark the top and bottom skin and rib where the reinforcement tapes are sewn on the rib and every 3-inches to be used as guide marks.
3. Layout the canopy and carefully cut the stitching and remove any items necessary to expose the damaged rib, such as suspension line attaching loops and reinforcing tapes.
4. Carefully cut and remove the double rows of stitching securing the rib to the top and bottom skin and remove the damaged rib.
5. Obtain a new rib from supply stock.
6. Using the damaged rib as a pattern, transfer the guide marks made in step 2., above, on to the replacement rib as required.
7. Starting at the tail end of the rib, fold and sew the bottom of the rib to the bottom skin with a double needle sewing machine, using size E nylon thread and 7 to 11 stitches per inch.

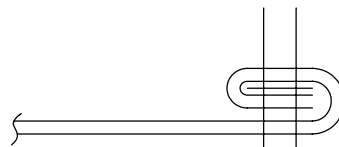

**RIB REPLACEMENT, BOTTOM SKIN**

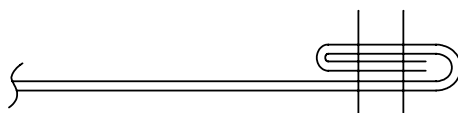

**CROSS SEAM, BOTTOM SKIN**



**NOSE SEAM, BOTTOM SKIN**

**NOTE**

When sewing the rib, pull tension on the bottom or top skin as required; however, let the rib material lay naturally to ensure the rib and the nose of the canopy fit correctly. Make adjustments as required using the guide marks made in step 1., above.

8. If the rib being replaced is a loaded rib, start at the tail of the rib, fold and sew a second double row of stitching using a double needle sewing machine, size E nylon thread and 7 to 11 stitches per inch.
9. Starting at the tail end of the rib, fold and sew the top skin with a double needle sewing machine, size E nylon thread and 7 to 11 stitches per inch.
10. If the rib being replaced is a loaded rib, start at the tail end of the rib, fold and sew a second row of stitching using a double needle sewing machine, size E nylon thread and 7 to 11 stitches per inch.

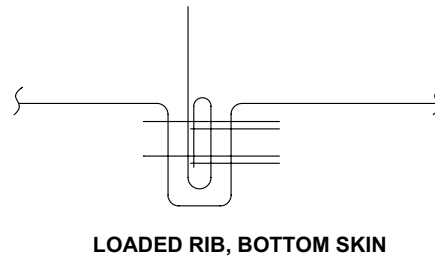
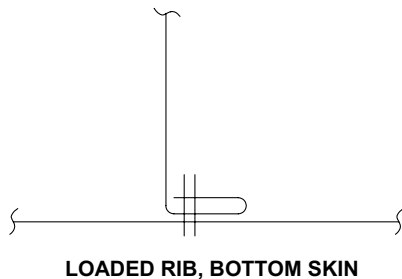

11. Re-sew the tail seam as required, in accordance with original construction and stitch formation.
12. Re-sew any reinforcement tapes as required, in accordance with original construction and stitch formation.

**NOTE**

When re-sewing the rib to the bottom skin, ensure that the reinforcement tapes on the rib are centered on the reinforcement tape running span wise. Ensure that the guide marks on the rib are aligned with the guide marks on the bottom skin in the case of the unloaded rib.

---

**NOTE**

When re-sewing the rib to the top skin, ensure that the reinforcement tape is aligned with the guide marks made in step 2., above. Ensure that the guide marks on the rib are aligned with the guide marks on the top skin in the case of the unloaded rib.

**REPLACEMENT (PARTIAL RIB)**

---

**NOTE**

Ribs may be partially replaced not to exceed 50 percent.

1. Cut stitching to open tail section approximately 12-inches on each side of the damaged rib.
2. Premark the top and bottom skin where the reinforcement tapes are sewn on the rib and every 3-inches ribs to be used as guide marks.
3. Carefully cut and remove any items necessary to expose the damaged rib such as suspension line attaching loops and reinforcement tapes.
4. Carefully cut and remove the double row of stitching securing the rib to the top and bottom skin as necessary to expose only the damaged portion of the rib.
5. Obtain a new rib from supply stock.
6. Using the damaged rib as a pattern, mark the new rib as required to allow for a  $\frac{3}{4}$  -inch seam.
7. Sew the new and old rib together using two rows of straight stitching.
8. Again, using the damaged rib as a pattern, transfer the guide marks made in step 2., above on to the replacement rib as required.
9. Starting at the tail end of the rib, fold and sew the bottom of the rib to the bottom skin with a double needle sewing machine, using size E nylon thread and 7 to 11 stitches per inch.

---

**NOTE**

When sewing the rib, pull tension on the bottom or top skin as required, however, let the rib lay naturally to ensure the rib and the nose of the canopy fit correctly. Make adjustments as required using the guide marks made in step 2., above.

10. If the rib being replaced is a loaded rib, start at the tail end of the rib, fold and sew a second double row of stitching, using a double needle sewing machine, size E nylon thread and 7 to 11 stitches per inch.

11. Starting at the tail end of the rib, fold and sew the top skin with a double needle sewing machine, size E nylon thread and 7 to 11 stitches per inch.
12. If the rib is a loaded rib, start at the tail end fold and sew a second row of stitching, using a double needle sewing machine, size E nylon thread and 7 to 11 stitches per inch.
13. Re-sew the tail seam as required according to original construction and stitch formation.
14. Re-sew any reinforcement tape as required according to original construction and stitch formation.
15. Replace any crossport holes as required, IAW WP 0027 00.

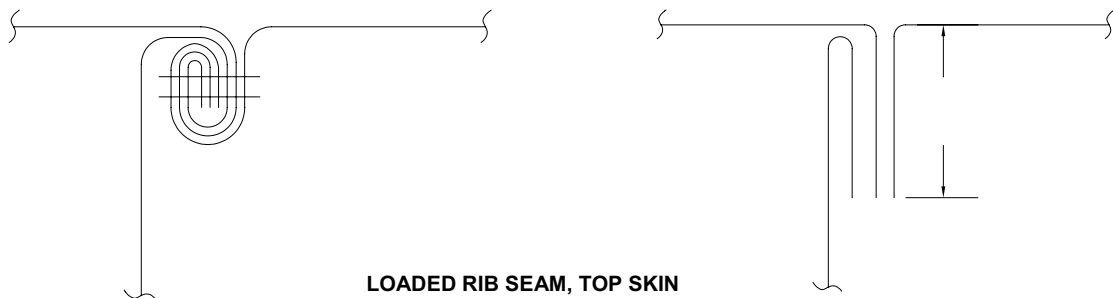
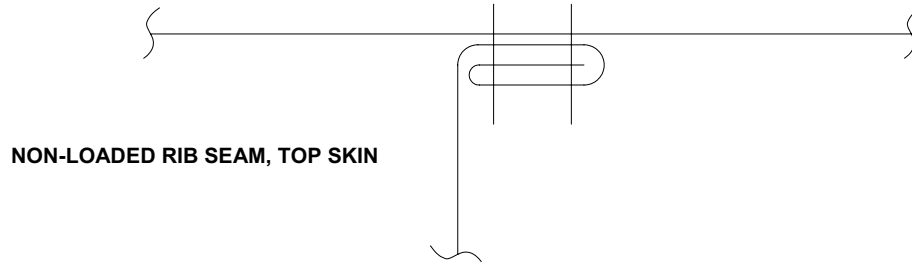

**END OF WORK PACKAGE**

---

**DIRECT SUPPORT MAINTENANCE  
MC-4 RAM AIR FREE-FALL PERSONNEL PARACHUTE SYSTEM  
SECTION REPLACEMENTS**

---

**THIS TASK COVERS:**

- Replace
- 

**INITIAL SETUP:****Tools**

Needle, Tacking (Item 29, WP 0063 00)  
Sewing Machine, Medium-Duty (Table 1, WP 0050 00)  
Shears (Item 39, WP 0063 00)  
Stitch Removal Tool (Item 40, WP 0063 00)  
Tape Measure (Item 42, WP 0063 00)

**Equipment Condition**

Layout on packing table or other suitable area.

**Personnel Required**

92R (10) Parachute Rigger

**Materials/Parts**

Cloth, Nylon Ripstop, Type I (Item 9, WP 0076 00)  
Thread, Nylon, Size A (Item 45, WP 0076 00)  
Thread, Nylon, Size E (Item 43/44, WP 0076 00)

---

**REPLACE**

---

**NOTE**

---

Due to complexity of repair, it is recommended that pre-fabricated repair parts be purchased via construction from bolt material.

1. A canopy section is defined as an area between loaded ribs on the left and right side (rigger view) and from seam to seam from the nose to the tail.
2. Carefully cut and remove any items necessary to expose the damaged section, such as suspension line attaching loops and reinforcement tapes.
3. Carefully cut and remove the double rows of stitching securing the ribs to the damaged section.
4. Carefully cut and remove all stitching securing the damaged section to the nose and tail seam side of the section.
5. Using the two (2) double rows of stitching that secured both loaded ribs to the section as a guide, draw a line the width of the section between the double rows using an authorized marking aid. Draw a second line  $\frac{1}{4}$ -inch in from the previous width of the section to allow for a  $\frac{1}{4}$ -inch fold back.
6. Cut along the second line of both loaded ribs and remove the damaged area leaving approximately  $\frac{1}{4}$ -inch of material.
7. Measure the damaged panel. Using the ripstop blocks as a guide cut a new piece of replacement material. Ensure the replacement piece is 1-inch wider (spanwise) and the same length on the nose to tail side.
8. Sew the new section material to the adjacent section with one (1) row of straight stitching  $\frac{1}{4}$ -inch from the edge on both the left and right sides, using size E, nylon thread, 7 to 11 stitches per inch, ensuring the raw edge is to the inside (see illustrations marked VIEW 1, TOP SKIN, and VIEW 4, BOTTOM SKIN).

---

**NOTE**

---

Ensure the raw edges of the seams are sewn to the inside of the canopy.

9. Sew the side closest to the nose side of the section with a double row of stitching as close to the original construction as possible using a double needle sewing machine, size E nylon thread, and 7 to 11 stitches per inch.
10. Re-sew any reinforcement tape as close to the original stitching construction as possible.

---

**NOTE**

---

If the fourth section is the section being repaired, do not re-sew tail seam until all ribs have been re-sewn.

11. Re-sew the side closest to the tail side of the section using double needle sewing machine, size E nylon thread and 7 to 11 stitches per inch.
12. Re-sew the loaded ribs with a double row of straight stitching as shown in the illustration known as VIEWS 2 & 5.

---

**NOTE**

---

When re-sewing the rib to the new section, pull tension on the top and bottom skin as required ensuring the rib and the end of the section fits back into its original place.

---

**NOTE**

---

The loaded ribs are sewn on top of the ¼-inch seam sewn in step 8., above (see illustrations known as VIEWS 2 & 5). Ensure that raw edges are not visible.

13. Using the ripstop blocks as a guide, re-sew the non-loaded rib to the center of the section with a double row of stitching using a double needle sewing machine, size E nylon thread and 7 to 11 stitches per inch (see illustrations known as VIEWS 2 & 5).
14. Fold and sew the loaded ribs with a second double row of straight stitching as shown in the illustrations known as VIEWS 3 & 6.
15. After sewing the loaded ribs, ensure that all raw edges of the new material are hidden between the double rows of stitching. Ensure that the stitching cannot be seen on the outside of the canopy both on the top and bottom skins.
16. If the canopy section is located near the tail, close the tail as required.
17. Re-sew any reinforcement tapes as required.

ILLUSTRATION OF SECTION REPLACEMENT TOP SKIN

VIEW 1

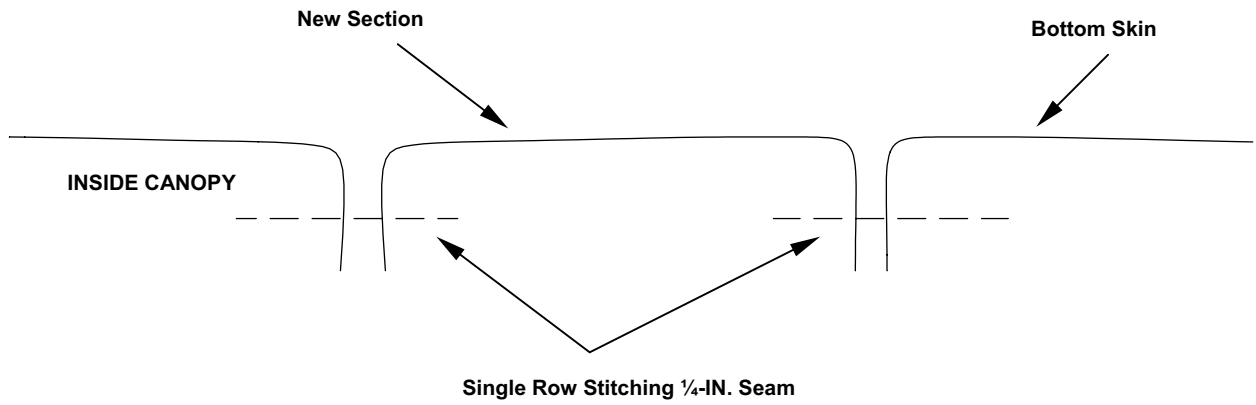

VIEW 2

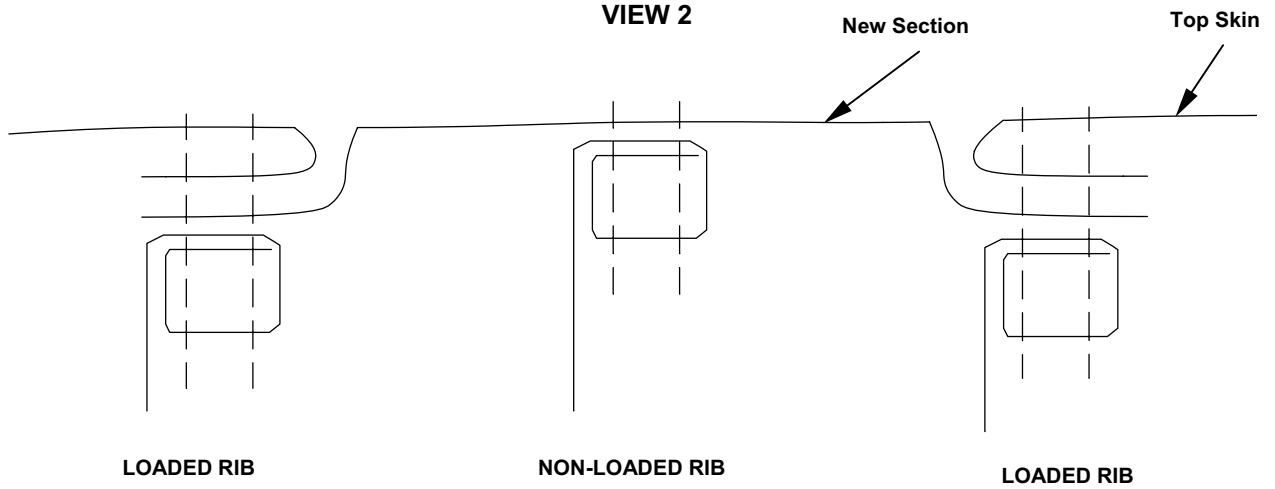

VIEW 3

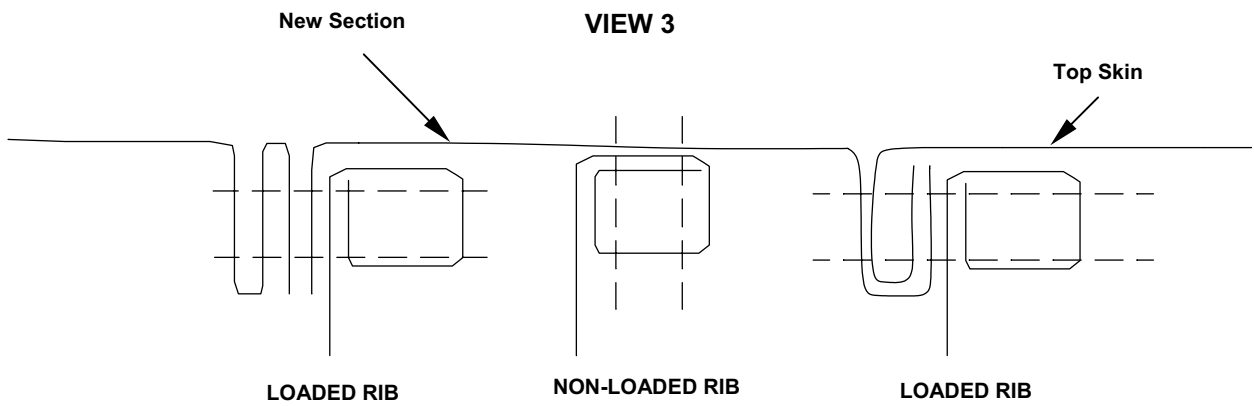

**SECTION REPLACEMENT BOTTOM SKIN**

**VIEW 4**

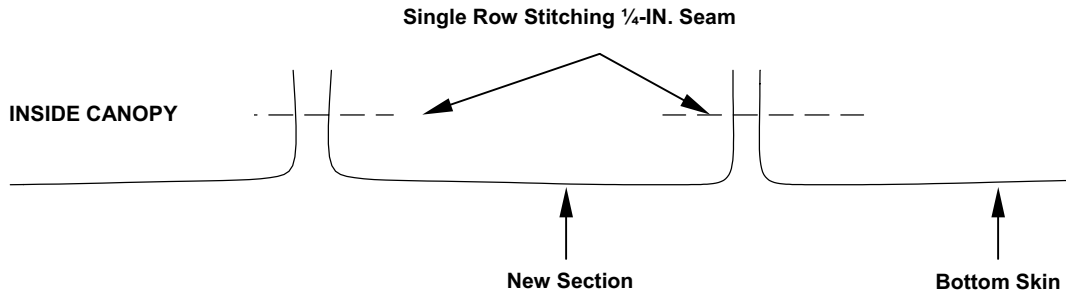

**VIEW 5**

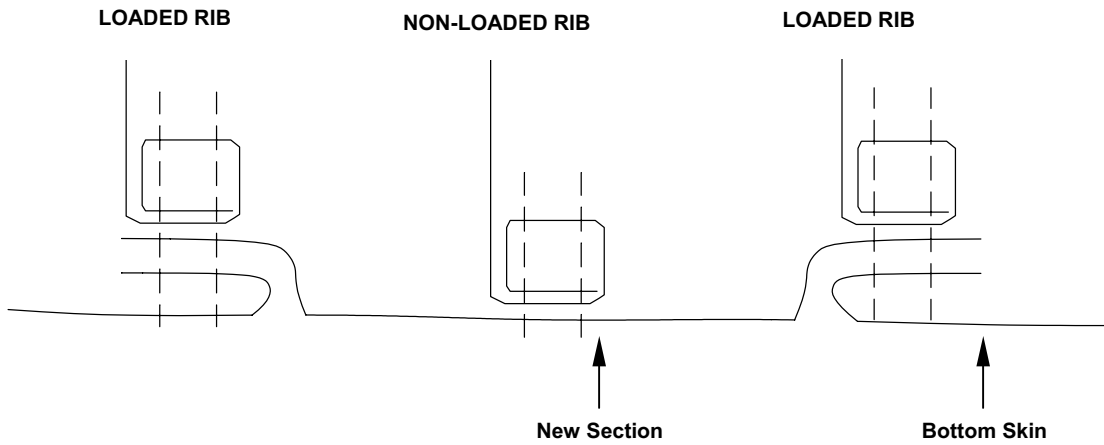

**VIEW 6**

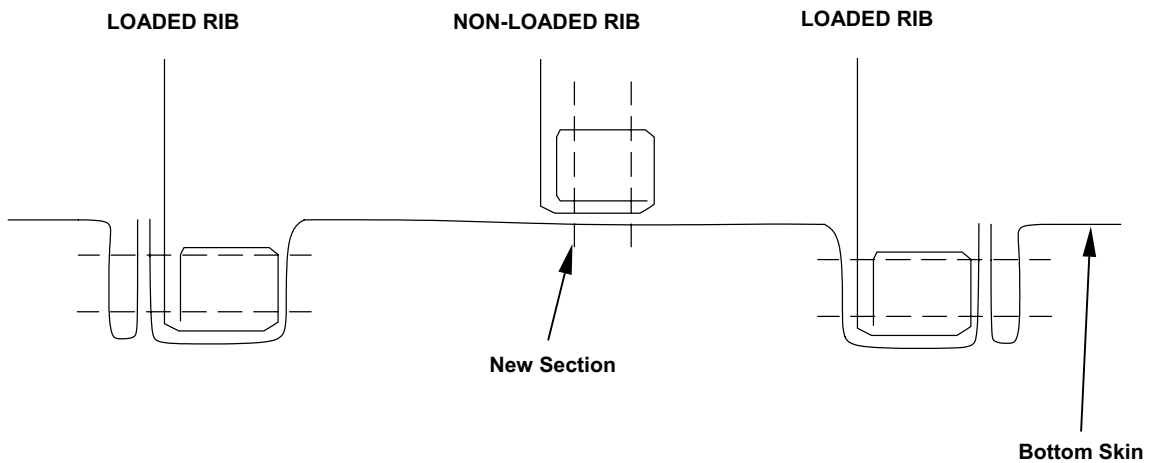

**END OF WORK PACKAGE**



**CHAPTER 5**  
**SUPPORTING INFORMATION**  
**FOR**  
**MC-4 RAM AIR FREE-FALL**  
**PERSONNEL PARACHUTE SYSTEM**



---

**SUPPORTING INFORMATION**  
**MC-4 RAM AIR FREE-FALL PERSONNEL PARACHUTE SYSTEM**  
**PREPARATION FOR STORAGE**

---

**THIS TASK COVERS:**

- Storage Criteria
  - General Storage Requirements
  - Storage Specifics for Parachutes
  - In-Storage Inspection
- 

**INITIAL SETUP:****Equipment Condition**  
Unpacked.**Personnel Required**  
92R (10) Parachute Rigger

---

**STORAGE CRITERIA**

Administrative storage of the MC-4 Ram Air Personnel Parachute System will be accomplished in accordance with AR 750-1, and the instructions furnished below.

**GENERAL STORAGE REQUIREMENTS**

To ensure that serviceability standards of the stored parachute assembly are maintained, every effort will be exerted to adhere to the following general storage requirements:

1. When available, a heated building should be used to store parachutes.
2. Parachutes will be stored in a dry, well-ventilated location and protected from pilferage, dampness, fire, dirt, insects, rodents, and direct sunlight.
3. Parachutes will not be stored in a manner which would prevent ventilation or interfere with light fixtures, heating vents, fire fighting devices, cooling units, exits, or fire doors.
4. Parachutes will not be stored in a damaged, dirty, or damp condition.
5. All stored parachute items will be marked, segregated, and located for accessibility and easy identification.
6. Parachutes will not be stored in direct contact with any building floor or wall. Storage will be accomplished using bins, shelves, pallets, racks, or dunnage to provide airspace between the storage area floor and the equipment. If the pre-constructed shelving or similar storage accommodations are not available, locally fabricate storage provisions using suitable lumber or wooden boxes.
7. All available material handling equipment should be used as much as possible in the handling of parachutes.
8. Periodic rotation of stock, conversion of available space, proper housekeeping policies, and strict adherence to all safety regulations will be practiced at all times.

**STORAGE SPECIFICS FOR PARACHUTES**

In addition to the storage requirements stipulated in the general storage requirements paragraph, above, the following is a list of specifics that must be enforced when storing parachutes:

1. Except for those assemblies required for contingency operation, parachutes will not be stored in a packed configuration.

2. Stored parachute assemblies will be secured from access by unauthorized personnel.
3. A parachute that is in storage, and is administered a cyclic repack and inspection, will not be exposed to incandescent light or indirect sunlight for a period of more than 36-hours. In addition, exposure to direct sunlight will be avoided entirely.

#### **IN-STORAGE INSPECTION**

1. General Information. An in-storage inspection is a physical check conducted on a random sample of parachutes that are located in storage.
2. Intervals. MC-4 parachutes in-storage will be inspected at least once every 180 calendar days and at more frequent intervals if prescribed by the local parachute maintenance officer.
3. Inspection. Inspect to ensure that the parachute is ready for issue.
4. Check the parachute for proper identification.
5. Check that no damage or deterioration has been incurred.
6. Ensure that all modifications or similar requirements have been completed.
7. Check the adequacy of the storage facilities, efforts taken to control pests and rodents, and protection against unfavorable climatic conditions.

**END OF WORK PACKAGE**

---

**SUPPORTING INFORMATION**  
**MC-4 RAM AIR FREE-FALL PERSONNEL PARACHUTE SYSTEM**  
**PREPARATION FOR SHIPMENT**

---

**THIS TASK COVERS:**

- In-Storage Inspection
  - Shipment
  - Accordion Folding/Rigger Rolling
- 

**INITIAL SETUP:**

**Equipment Condition**  
 Unpacked.

**Personnel Required**  
 92R (10) Parachute Rigger

---

**SHIPMENT**

**Initial Shipment.** The initial packaging and shipping of parachutes are the responsibility of item manufacturers, who are required to comply with federal and military packing specifications, as stipulated in contractual agreements. Parachutes are normally shipped to depot activities, by domestic freight or parcel post, and packed to comply with overseas shipping requirements. Except for those parachute that are unpackaged and subjected to random inspections or testing by depot activity, parachutes received by a using unit will be contained in the original packaging materials.

**Shipping Between Maintenance Activities.** The shipping of parachutes between activities will be accomplished on a signature verification basis using whatever means of transportation is available. Used parachutes and other fabric items will be tagged in accordance with DA PAM 738-751, and rolled, folded, or placed loosely in a parachute pack, deployment bag, or other suitable container, as required. Unused parachutes will be transported in original shipping containers. During shipment, every effort will be made to protect parachute from weather elements, dust, dirt, oil, grease, and acids. Vehicles used to transport parachutes will be inspected to ensure the items are protected from the previously cited material damaging conditions.

**Other Shipping Instructions.** Parachutes destined for domestic or overseas shipment will be packaged and marked in accordance with AR 700-15. Shipment of parachutes will be accomplished in accordance with TM 10-1670-201-23/T.O. 13C-1-41/NAVAIR 13-1-17.

**ACCORDION FOLDING/RIGGER ROLLING**

Accordion Folding. Personnel parachute canopy assemblies that are not packed for use should be accordion folded prior to entry into storage. To accordion fold a parachute canopy assembly, perform the following:

1. Place the parachute canopy in proper layout. Tie risers or connector links with log record book.
2. Fold tail and nose toward center in approximately 10 to 12-inch folds until they meet.
3. Move slider up to bottom of canopy and daisy-chain suspension lines.
4. Fold lines, slider, and stabilizer panels toward top of canopy, keeping lines centered on canopy.
5. Fold canopy in half top to bottom, then in half left to right.
6. Tie folded canopy top to bottom and-left to right using  $\frac{1}{4}$ -inch cotton webbing.
7. Tag assembly in accordance with DA PAM 738-751.

**Rigger Rolling.** Personnel parachute assemblies will be rigger rolled prior to being sent to or returned from a parachute repair activity for ease of handling and to prevent suspension line entanglement. MC-4 parachutes are rigger rolled in the same manner as accordion folding.

**END OF WORK PACKAGE**

---

**SUPPORTING INFORMATION**  
**MC-4 RAM AIR FREE-FALL PERSONNEL PARACHUTE SYSTEM**  
**REFERENCES**

---

**THIS WORK PACKAGE COVERS:**

- Scope
  - Publication Indexes
  - Technical Manuals
  - Field Manuals
  - Army Regulations
  - Technical Bulletins
  - Forms
  - Air Force Technical Orders
  - Air Force Technical Order Forms
  - Marine Corps Forms
- 

**SCOPE**

This appendix lists all forms, technical manuals, and miscellaneous publications referenced in this manual.

**PUBLICATION INDEXES**

The following publication indexes should be consulted frequently for the latest changes or revisions of references given in this work package, and for new publications relating to the material covered in this manual:

**DA PAM**

Consolidated Index of Army Publications and Blank Forms	DA PAM 25-30
The Army Maintenance Management System, Users Manual (TAMMS)	DA PAM 750-8
Functional Users Manual for The Army Maintenance Management System (Aviation) (TAMMSA)	DA PAM 738-751

**TECHNICAL MANUALS**

General Maintenance of Parachutes and Other Airdrop Equipment	TM 10-1670-201-23/ T.O. 13C-1-41/ NAVAIR 13-1-17
Equipment Maintenance Forms and Procedures	TM 4700-15/1/
Procedures for the Destruction of Air Delivery Equipment to Prevent Enemy Use	TM 43-0002-1/ T.O. 13C3-1-10/ NAVAIR 13-1-19

**FIELD MANUALS**

First Aid for Soldiers	FM 4-25.11
Military Free-Fall Parachuting	FM 31-19

**ARMY REGULATIONS**

Authorized Abbreviation and Brevity Codes and Acronyms	AR 25-52
--	----------

---

Accident Reporting and Records	AR 385-40
Packaging of Material	AR 700-15
Army Materiel Maintenance Policy	AR 750-1
Air Drop, Parachute Recovery and Aircraft Personal Escape Systems	AR 750-32

**TECHNICAL BULLETINS**

Maintenance Expenditure Limits for FSC Group 16, FSC Class 1670	TB 43-0002-43
---	---------------

**JOINT REGULATIONS**

Defense Disposal Manual	DOD 4160.21-M
Department of Defense Dictionary of Military and Associated Terms	Joint Pub 1-02
Joint Airdrop Inspection records, Malfunction Investigations and Activity Reporting	AR 59-4/AFR 55-10/OPNAVINST 4360-24B/MCO 13480-1B

**FORMS**

Parachute Log Record	DA Form 3912
Recommended Changes to Publications	DA Form 2028
Equipment Inspection & Maintenance Worksheet	DA Form 2404
Product Quality Deficiency Report	SF 368/AFR 900-4/MCO 1650.17

**AIR FORCE TECHNICAL ORDERS**

Cleaning of Parachute Assemblies	T.O. 14D1-1-2
Parachute Logs and Records	T.O. DO-25-241



**AIR FORCE TECHNICAL ORDER FORMS**

Parachute Log AFTO 391

Parachute Repack Inspection and Component Card AFTO 392

**MARINE CORPS FORMS**

Marine Corps Military Incentive Awards Program MCO 1650.17F

Parachute History Record NAV WPN CEN or NAV  
WPNS CL 13512/11

Product Quality Deficiency Report (PQDR) MCO 4855.10B

Recommended Changes to Technical Publications NAVMC 10772

**END OF WORK PACKAGE**



---

**SUPPORTING INFORMATION**  
**MC-4 RAM AIR FREE-FALL PERSONNEL PARACHUTE SYSTEM**  
**MAINTENANCE ALLOCATION CHART (MAC)**

---

**THIS WORK PACKAGE COVERS:**

- Introduction
  - Maintenance Functions
  - Explanation of Columns in the MAC
  - Explanation of Columns in Tool and Test Equipment Requirements
  - Explanation of Column in Remarks
- 

**INTRODUCTION****The Army Maintenance System MAC**

This section provides a general explanation of all maintenance and repair functions authorized at the two maintenance levels under the Two-Level Maintenance System concept.

The MAC (immediately following the introduction) designates overall authority and responsibility for the performance of maintenance functions on the identified end item or component. The application of the maintenance functions to the end item or component shall be consistent with the capacities and capabilities of the designated maintenance levels, which are shown in the MAC in column (4) as:

Field – includes two columns, Unit maintenance and Direct Support maintenance. The Unit maintenance column is divided again into two more subcolumns, C for Operator or Crew and O for Unit maintenance.

Sustainment – includes two subcolumns, General Support (H) and Depot (D).

The tools and test equipment requirements (immediately following the MAC) list the tools and test equipment (both special tools and common tool sets) required for each maintenance function as referenced from the MAC.

The remarks (immediately following the tools and test equipment requirements) contain supplemental instructions and explanatory notes for a particular maintenance function.

**Maintenance Functions**

Maintenance functions are limited to and defined as follows:

1. **Inspect.** To determine the serviceability of an item by comparing its physical, mechanical, and/or electrical characteristics with established standards through examination (e.g., by sight, sound, or feel.) This includes scheduled inspection and gagings and evaluation of cannon tubes.
2. **Test.** To verify serviceability by measuring the mechanical, pneumatic, hydraulic, or electrical characteristics of an item and comparing those characteristics with prescribed standards on a scheduled basis, i.e., load testing of lift devices and hydrostatic testing of pressure hoses.
3. **Service.** Operations required periodically to keep an item in proper operating condition; e.g., to clean (includes decontaminate, when required), to preserve, to drain, to paint, or to replenish fuel, lubricants, chemical fluids, or gases. This includes scheduled exercising and purging of recoil mechanisms. The following are examples of service functions:
  - a. **Unpack.** To remove from packing box for service or when required for the performance of maintenance operations.

- b. Repack. To return item to packing box after service and other maintenance operations.
  - c. Clean. To rid the item of contamination.
  - d. Touch up. To spot paint scratched or blistered surfaces.
  - e. Mark. To restore obliterated identification.
4. Adjust. To maintain or regulate, within prescribed limits, by bringing into proper position, or by setting the operating characteristics to specified parameters.
  5. Align. To adjust specified variable elements of an item to bring about optimum or desired performance
  6. Calibrate. To determine and cause corrections to be made or to be adjusted on instruments of test, measuring, and diagnostic equipment used in precision measurement. Consists of comparisons of two instruments, one of which is a certified standard of known accuracy, to detect and adjust any discrepancy in the accuracy of the instrument being compared.
  7. Remove/Install. To remove and install the same item when required to perform service or other maintenance functions. Install may be the act of emplacing, seating, or fixing into position a spare, repair part, or module (component or assembly) in a manner to allow the proper functioning of an equipment or system.
  8. Paint. To prepare and spray color coats of paint so that the ammunition can be identified and protected. The color indicating primary use is applied, preferably, to the entire exterior surface as the background color of the item. Other markings are to be repainted as original so as to retain proper ammunition identification.
  9. Replace. To remove an unserviceable item and install a serviceable counterpart in its place. "Replace" is authorized by the MAC and assigned maintenance level is shown as the third position code of the Source, Maintenance and Recoverability (SMR) code.
  10. Repair. The application of maintenance services, including fault location/troubleshooting, removal/installation, disassembly/assembly procedures and maintenance actions to identify troubles and restore serviceability to an item by correcting specific damage, fault, malfunction, or failure in a part, subassembly, module (component or assembly), end item, or system.

### NOTE

The following definitions are applicable to the "repair" maintenance function:

Services. Inspect, test, service, adjust, align, calibrate, and/or replace.

Fault location/troubleshooting. The process of investigating and detecting the cause of equipment malfunctioning; the act of isolating a fault within a system or Unit Under Test (UUT).

Disassembly/assembly. The step-by-step breakdown (taking apart) of a spare/functional group coded item to the level of its least component, that is assigned an SMR code for the level of maintenance under consideration (i.e., identified as maintenance significant).

Actions. Welding, grinding, riveting, straightening, facing, machining, and/or resurfacing.

11. Overhaul. That maintenance effort (service/action) prescribed to restore an item to a completely serviceable/operational condition as required by maintenance standards in appropriate technical publications. Overhaul is normally the highest degree of maintenance performed by the Army. Overhaul does not normally return an item to like new condition.
12. Rebuild. Consists of those services/actions necessary for the restoration of unserviceable equipment to a like new condition in accordance with original manufacturing standards. Rebuild is the highest degree of material maintenance applied to Army equipment. The rebuild operation includes the act of returning to zero those age measurements (e.g., hours/miles.) considered in classifying Army equipment/components.

### Explanation of Columns in the MAC

Column (1) Group Number. Column (1) lists Functional Group Code (FGC) numbers, the purpose of which is to identify maintenance significant components, assemblies, subassemblies, and modules with the Next Higher Assembly (NHA).

Column (2) Component/Assembly. Column (2) contains the names of components, assemblies, subassemblies, and modules for which maintenance is authorized.

Column (3) Maintenance Function. Column (3) lists the functions to be performed on the item listed in column (2). (For a detailed explanation of these functions refer to "Maintenance Functions" outlined above).

Column (4) Maintenance Level. Column (4) specifies each level of maintenance authorized to perform each function listed in column (3), by indicating work time required (expressed as manhours in whole hours or decimals) in the appropriate subcolumn. This work time figure represents the active time required to perform that maintenance function at the indicated level of maintenance. If the number or complexity of the tasks within the listed maintenance function varies at different maintenance levels, appropriate work time figures are to be shown for each level. The work time figure represents the average time required to restore an item (assembly, subassembly, component, module, end item, or system) to a serviceable condition under typical field operating conditions. This time includes preparation time (including any necessary disassembly/assembly time), troubleshooting/fault location time, and quality assurance time in addition to the time required to perform the specific tasks identified for the maintenance functions authorized in the MAC. The system designations for the various maintenance levels are as follows:

#### Field:

- C Operator or Crew maintenance
- O Unit maintenance
- F Direct Support maintenance

#### Sustainment:

- L Specialized Repair Activity
- H General Support maintenance
- D Depot maintenance

## NOTE

The "L" maintenance level is not included in column (4) of the MAC. Functions to this level of maintenance are identified by work time figure in the "H" column of column (4), and an associated reference code is used in the REMARKS column (6). This code is keyed to the remarks and the SRA complete repair application is explained there.

Column (5) Tools and Equipment Reference Code. Column (5) specifies, by code, those common tool sets (not individual tools), common Test, Measurement and Diagnostic Equipment (TMDE), and special tools, special TMDE and special support equipment required to perform the designated function. Codes are keyed to the entries in the tools and test equipment table.

Column (6) Remarks Code. When applicable, this column contains a letter code, in alphabetic order, which is keyed to the remarks table entries.

### Explanation of Columns in Tools and Test Equipment Requirements

Column (1) - Tool or Test Equipment Reference Code. The tool or test equipment reference code correlates with a code used in column (5) of the MAC.

Column (2) - Maintenance Level. The lowest level of maintenance authorized to use the tool or test equipment.

Column (3) - Nomenclature. Name or identification of tool or test equipment.

Column (4) - National Stock Number (NSN). The NSN of the tool or test equipment.

Column (5) - Tool Number. The manufacturer's part number.

### Explanation of Columns in Remarks

Column (1) - Remarks Code. The code recorded in column (6) of the MAC.

Column (2) - Remarks. This column lists information pertinent to the maintenance function being performed as indicated in the MAC.

**Table 1. Maintenance Allocation Chart  
for the MC-4 Ram Air Free-Fall Personnel Parachute System**

(1) GROUP NUMBER	(2) COMPONENT/ ASSEMBLY	(3) MAINTENANCE FUNCTION	(4) MAINTENANCE LEVEL					(5) TOOLS AND EQUIPMENT REFERENCE CODE	(6) REMARKS	
			FIELD		SUSTAINMENT					
			UNIT		DIRECT SUPPORT	GENERAL SUPPORT	DEPOT			
			C	O	F	H	D			
00	MC-4 RAM AIR PARACHUTE SYSTEM							Table 2 in this WP.		
01	DEPLOYMENT BAG	Inspect Repair Replace		0.1 0.5 0.3				Table 2 in this WP.	A	
0101	GROMMET	Inspect Replace		0.1 0.3					A	
0102	SUPPORT WEBBING	Inspect Repair		0.1 0.2					A E	
02	DEPLOYMENT SYSTEM, RESERVE	Inspect Replace		0.2 0.1				Table 2 in this WP.	A	
0201	PILOT PARACHUTE	Inspect Replace		0.1 0.2					A	
0202	DEPLOYMENT BAG AND BRIDLE ASSEMBLY	Inspect Replace		0.1 0.2					A	
0203	SAFETY LOOP	Inspect Replace		0.1 0.2					A	
03	CANOPY, MAIN	Service Inspect Repair Replace		1.0 0.5 1.5 1.0				Table 2 in this WP.	B C A D,E	
0301	SUSPENSION LINES	Inspect Replace		0.3	1.0				A	
0302	CONTROL LINES	Inspect Replace		0.3	1.0				A	
0303	CASCADE LINE	Inspect Replace		0.3	1.0				A	
0304	SLIDER	Inspect Repair Replace		0.1 0.3 0.1					A E	
0305	CROSSPORTS	Inspect Repair Replace		0.1 0.3 1.0					A E	

**Table 1. Maintenance Allocation Chart  
for the MC-4 Ram Air Free-Fall Personnel Parachute System - continued**

(1) GROUP NUMBER	(2) COMPONENT/ ASSEMBLY	(3) MAINTENANCE FUNCTION	(4) MAINTENANCE LEVEL				(5) TOOLS AND EQUIPMENT REFERENCE CODE	(6) REMARKS	
			FIELD		SUSTAINMENT				
			UNIT		DIRECT SUPPORT	GENERAL SUPPORT			DEPOT
			C	O	F	H			D
0306	CANOPY RIB	Inspect Repair Replace		0.1 0.3	1.5			A	
0307	SECTION REPLACEMENTS	Inspect Repair Replace		0.1 0.3	1.5			A	
0308	STABILIZER	Inspect Replace		0.1 1.0				A E	
0309	TAIL SEAM	Inspect Repair Replace		0.1 0.5 0.8				A E	
0310	SUSPENSION LINE ATTACHING LOOP	Inspect Repair Replace		0.1 0.2 0.5				A E	
04	CANOPY, RESERVE	Service Inspect Repair Replace		1.0 0.5 1.5 1.0			Table 2 in this WP.	B, C A D, E	
0401	SUSPENSION LINES	Inspect Replace		0.3	1.0			A	
0402	CONTROL LINES	Inspect Replace		0.3	1.0			A	
0403	CASCADE LINE	Inspect Replace		0.3	1.0			A	
0404	SLIDER	Inspect Repair Replace		0.1 0.3 0.1				A E	
0405	CROSSPORTS	Inspect Repair Replace		0.1 0.3 1.0				A E	
0406	CANOPY RIB	Inspect Repair Replace		0.1 0.3	1.5			A	
0407	SECTION REPLACEMENTS	Inspect Repair Replace		0.1 0.3	1.5			A	
0408	STABILIZER	Inspect Replace		0.1 1.0				A E	



**Table 1. Maintenance Allocation Chart  
for the MC-4 Ram Air Free-Fall Personnel Parachute System - continued**

(1) GROUP NUMBER	(2) COMPONENT/ ASSEMBLY	(3) MAINTENANCE FUNCTION	(4) MAINTENANCE LEVEL					(5) TOOLS AND EQUIPMENT REFERENCE CODE	(6) REMARKS
			FIELD		SUSTAINMENT				
			UNIT		DIRECT SUPPORT	GENERAL SUPPORT	DEPOT		
			C	O	F	H	D		
0409	TAIL SEAM	Inspect Repair Replace		0.1 0.5 0.8					A E
0410	SUSPENSION LINE ATTACHING LOOP	Inspect Repair Replace		0.1 0.2 0.5					A E
05	RISERS, MAIN	Inspect Repair Replace		0.1 0.5 0.5				Table 2 in this WP.	A E
0501	CABLE FLUTE	Inspect Repair Replace		0.1 0.2 0.5					A E
0502	KEEPERS	Inspect Repair Replace		0.1 0.2 0.5					A E
06	HARNESS/CON TAINER ASSEMBLY	Inspect Service Repair Replace		0.5 1.0 1.0 1.0				Table 2 in this WP.	A B E
0601	GROMMETS	Inspect Repair Replace		0.1 0.3 0.3					
0602	SNAP FASTENERS	Inspect Repair Replace		0.1 0.3 0.3					
0603	RIPCORDER POCKET, MAIN	Inspect Repair Replace		0.1 0.2 0.5					A, G
0604	RIPCORDER POCKET, RESERVE	Inspect Repair Replace		0.1 0.2 0.5					A, G
0605	POCKET, FF-2	Inspect Repair		0.1 0.2					A E
0606	POCKET, AR2	Inspect Replace		0.1 0.8					A
0607	PACK STIFFENERS	Inspect Replace		0.1 0.5					A
0608	RIPCORDER PROTECTOR FLAP	Inspect Repair Replace		0.1 0.3 0.5					A E

**Table 1. Maintenance Allocation Chart  
for the MC-4 Ram Air Free-Fall Personnel Parachute System - continued**

(1) GROUP NUMBER	(2) COMPONENT/ ASSEMBLY	(3) MAINTENANCE FUNCTION	(4) MAINTENANCE LEVEL				(5) TOOLS AND EQUIPMENT REFERENCE CODE	(6) REMARKS	
			FIELD		SUSTAINMENT				
			UNIT		DIRECT SUPPORT	GENERAL SUPPORT			DEPOT
			C	O	F	H			D
0609	FASTENER, HOOK, PILE, TAPE	Inspect Repair Replace		0.1 0.3 0.5				A E	
0610	WAISTBAND	Inspect Repair Replace		0.1 0.3 0.5				A E	
0611	POWER CABLE ASSEMBLY, AR2	Inspect Replace		0.1 0.3				A	
0612	RESERVE CANOPY CONVERSION TO MAIN CANOPY	Inspect Replace		0.1 1.0				A, B, C, D	
0613	AR2 POWER CABLE SLEEVE	Inspect Replace		0.1 1.0				A	

**Table 2. Tool and Test Equipment Requirements  
for the MC-4 Ram Air Free-Fall Personnel Parachute System**

(1) TOOL OR TEST EQUIPMENT REFERENCE CODE	(2) MAINTENANCE LEVEL	(3) NOMENCLATURE	(4) NATIONAL STOCK NUMBER	(5) TOOL NUMBER
1	O	Anvil, Chuck Fastener	5120-00-357-6181	9902
2	O	Bit, Drill, <sup>5</sup> / <sub>32</sub> -IN.	5133-00-227-9652	11418
3	O	Bit, Drill, Countersink, <sup>5</sup> / <sub>8</sub> -IN, Set	5133-00-529-4577	GGG-C-613
4	O	Brush, Scrub, Household	7920-00-282-2470	A-A-2074
5	O	Brush, Stenciling	7510-00-248-9285	H-B-118
6	O	Chuck	5120-00-144-2084	1410
7	O	Chuck	5120-00-144-2088	1412
8	O	Die	5120-00-090-4412	1401
9	O	Die	5120-00-144-2097	1407
10	O	Die Set, Spur Grommet, No. 0	5120-00-221-1146	17-0
11	O	Die Set, Spur Grommet, No. 2	5120-00-221-1148	17-2
12	O	Die Set, Spur Grommet, No. 5	5120-00-221-1151	17-5
13	O	Die Set, Spur Grommet, No. 8	5120-00-221-1142	216-8
14	O	Drill, Electric, <sup>3</sup> / <sub>8</sub> -IN. Drive	5130-00-935-7354	SP6039
15	O	File, Flat, 1-IN.	5110-00-249-2850	GGG-F-325
16	O	Finger Trap Tool	WP 0075 00	N/A
17	O	Grommet Setting, Stainless Steel, #0	Local Purchase	
18	O	Grommet Setting, Stainless Steel, #2	Local Purchase	
19	O	Hammer, Ball Peen, 16-oz.	5120-00-114-5499	GGG-H-86
20	O	Holder, Die, Fastener	5120-00-357-6177	192
21	O	Inspection Kit, Ripcord Grip	1670-00-910-3866	11-1-0595
22	O	Key, Socket Head Set (Allen Type)	5120-00-729-6392	GGG-K-275
23	O	Knife	5110-00-162-2205	MIL-K-818C
24	O	Knife, Hot Metal	3439-01-197-7656	4025 (78976)
25	O	Lead, Pig, 5-Pounds	9650-00-264-5050	QQ-C-40
26	O	Machine, Stencil Cutting	7490-00-164-0541	A-A-2722
27	O	Mallet, Rawhide	5120-00-293-3397	GGG-H-33
28	O	Needle, Basting	8315-00-281-9484	FF-N-180
29	O	Needle, Tacking	8315-00-262-3733	FF-N-180
30	O	Packing Paddle	1670-00-764-6381	11-1-152
31	O	Pins, Temporary Locking	Locally MFG	N/A
32	O	Pliers, Large, Diagonal Cut	5110-00-222-2708	GGG-P-468
*33	O	Porosity Machine, Gurley Model #4301	Local Purchase	4301
34	O	Pot, Melting, Electric	5120-00-924-5213	L-115
35	O	Press, Hand Operated	5120-00-880-0619	A741
36	O	Punch, Center	5120-00-221-1072	GGG-P-831
37	O	Screwdriver, Flat-tip, <sup>1</sup> / <sub>4</sub> -IN.	5120-00-596-8653	GGG-S-121
38	O	Screwdriver, Phillips, No. 2	5120-00-234-8913	2752
39	O	Shears	5110-00-223-6370	GGG-S-00278

**Table 2. Tool and Test Equipment Requirements  
for the MC-4 Ram Air Free-Fall Personnel Parachute System - continued**

(1) TOOL OR TEST EQUIPMENT REFERENCE CODE	(2) MAINTENANCE LEVEL	(3) NOMENCLATURE	(4) NATIONAL STOCK NUMBER	(5) TOOL NUMBER
40	O	Stitch Removal Tool	Local Purchase	N/A
41	O	Stroke Simulator	1670-01-428-7637	11-1-4054-1
42	O	Tape Measure	5210-00-182-4797	W7312
43	O	Template, Crossport, Oversized	Local Purchase	0471-0
44	O	Template, Crossport, Standard	Local Purchase	0471-1
45	O	Wrench, <sup>7</sup> / <sub>16</sub> -IN. Open End	5120-00-228-9505	A-A-1358
46	O	Wrench, Adjustable, 6-IN.	5120-00-264-3795	5385A12
<p>* Gurley Precision Instruments 514 Fulton Street Troy, New York 12181 (518) 274-0336 www.gurley.com</p>				

**Table 3. Remarks  
for the MC-4 Ram Air Free-Fall Personnel Parachute System**

(1) REMARKS CODE	(2) REMARKS
A	Inspect is a Technical Rigger Type Inspection.
B	Service is cleaning of equipment.
C	Service is the packing of parachutes.
D	Repair by restitching, darning, retacking, or restencilling the canopy panel.
E	Repair at the unit maintenance level consists of darning, restitching, patching and the replacement of parts authorized for unit maintenance.
F	Repair by darning, retacking, restitching, splice the edge binding, and repairing grommets.
G	Replacement of parts authorized for unit maintenance. Perform ripcord pocket test.

END OF WORK PACKAGE

**SUPPORTING INFORMATION**  
**MC-4 RAM AIR FREE-FALL PERSONNEL PARACHUTE SYSTEM**  
**REPAIR PARTS AND SPECIAL TOOLS LIST (RPSTL), INTRODUCTION**

**SCOPE**

This manual lists and authorizes spare and repair parts; special tools; special test, measurement, and diagnostic equipment (TMDE); and other special support equipment required for performance of organizational, direct support, and general support maintenance of the MC-4 Ram Air Free-Fall Personnel Parachute System. It authorizes the requisitioning, issue, and disposition of spares, repair parts and special tools, as indicated by the Source, Maintenance and Recoverability (SMR) codes.

**GENERAL INFORMATION**

This Repair Parts and Special Tools List is divided into the following sections:

**WP 0057 00, Repair Parts List.** A list of spares and repair parts authorized by this RPSTL is for use in the performance of maintenance. The list also includes parts that must be removed for replacement of the authorized parts. Parts lists are composed of functional groups in ascending alphanumeric sequence, with the parts in each group listed in ascending figure, and item, number sequence. Bulk materials are listed.

**Special Tools List.** (Not Applicable). No special tools are required to assemble the MC-4 Parachute. Common tools are listed in WP 0056 00 because they are required for performance of packing and maintenance procedures/tasks. These tools are authorized under Chapter 1, WP 0001 00 of this manual.

**Cross Reference Indexes.** A list, in National Item Identification Number (NIIN) sequence, of all National Stock Numbers (NSN) appearing in the listings (WP 0074 00), followed by a list in alphanumeric sequence of all part numbers appearing in the listings (WP 0075 00). National stock numbers and part numbers are cross-referenced to each illustration figure and item number appearance.

**EXPLANATION OF COLUMNS**

**Column 1, Item No.** Indicates the number used to identify items called out in the illustration.

**Column 2, SMR Code.** The Source, Maintenance, and Recoverability (SMR) code is a 5-position code containing supply/requisitioning information, maintenance category authorization criteria, and disposition instructions, as shown in the following breakout:

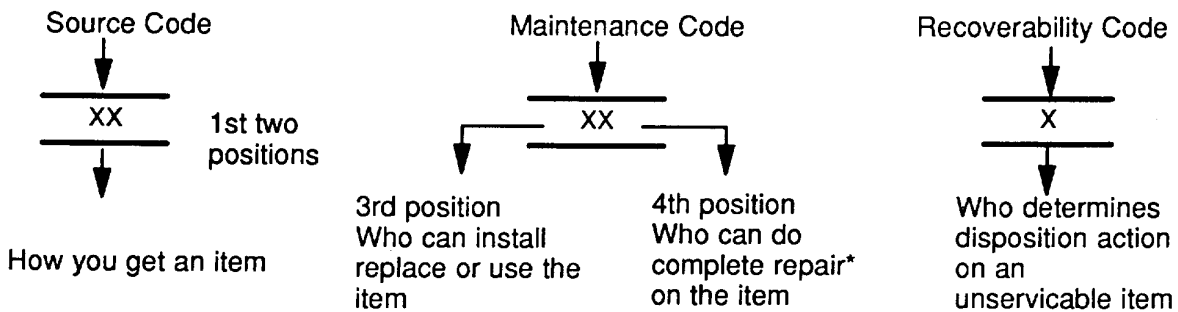

\*Complete Repair: Maintenance capacity, capability, and authority to perform all the corrective maintenance tasks of the REPAIR function in a use/user environment in order to restore serviceability to a failed item.

**Source Code.** The source code tells you how to get an item needed for maintenance, repair, or overhaul of an end item/equipment. Source codes are always the first and second positions of the SMR code. Explanations of source codes follow:

SOURCE CODE	EXPLANATION
PA PB PC PD PE PF PG	Stocked items: Use the applicable NSN to request/requisition items with these source codes. They are authorized to the category indicated by the code entered in the 3 <sup>rd</sup> position of the SMR code.
KD KF KF	Items with these codes are not to be requested/requisitioned individually. They are part of a kit that is authorized to the maintenance category indicated in the 3 <sup>rd</sup> position of the SMR code. The complete kit must be requisitioned and applied.
MO – (Made at org/AVUM Level) MF – (Made at DS/AVUM Level) MH – (Made at GS Level) ML – (Made at Specialized Repair Act (SRA)) MD – (Made at Depot)	Items with these codes are not to be requested/requisitioned individually. They must be made from bulk material that is identified by the part number in the DESCRIPTION and USABLE ON CODE (UOC) column and listed in the Bulk Material group of the repair parts list in the RPSTL. If the item is authorized to you by the 3 <sup>rd</sup> position code of the SMR code, but the source code indicates it is made at a higher level, order the item from the higher level of maintenance.
AO – (Assembled by org/AVUM Level) AF – (Assembled by DS/AVIM Level) AH – (Assembled by GS Category) AL – (Assembled by SRA) AD – (Assembled by Depot)	Items with these codes are not to be requested/requisitioned individually. The parts that make up the assembled item must be requisitioned or fabricated and assembled at the level of maintenance indicated by the source code. If the 3 <sup>rd</sup> position code of the SMR code authorizes you to replace the item, but the source code indicates the item is assembled at a higher level, order the item from the higher level of maintenance.
XA -	Do not requisition an XA-coded item. Order its next higher assembly. (Also, refer to the NOTE below.)
XB -	If and XB-coded item is not available from salvage, order it using the CAGEC and the given part number.
XC -	The installation drawing, diagram, instruction sheet, and field service drawing that is identified by manufacturers part number.
XD -	Item is not stocked. Order an XD-coded item through normal supply channels using the CAGEC and the part number given, if no NSN is available.

NOTE

Cannibalization or controlled exchanged, when authorized, may be used as a source of supply for items with the above source codes, except for those source coded XA or those aircraft support item restricted by requirements of AR 750-1.

**Maintenance Code.** Maintenance codes tell you the level(s) of maintenance authorized to USE and REPAIR support items. The maintenance codes are entered in the third and fourth positions of the SMR Code as follow:

**Third position.** The maintenance code entered in the third position tells you the lowest maintenance level authorized to remove, replace, and use an item. The maintenance code entered in the third position will indicate authorization to one of the following levels of maintenance.

MAINTENANCE CODE	APPLICATION/EXPLANATION
C -	Crew or operator maintenance done within organizational or aviation unit maintenance.
O -	Organizational or aviation unit category can remove, replace, and use the item.
F -	Direct support or aviation intermediate level can remove, replace, and use the item.
H -	General Support level can remove, replace, and use the item.
L -	Specialized repair activity can remove, replace, and use the item.
D -	Depot level can remove, replace, and use the item.

**Fourth position.** The maintenance code entered in the fourth position tells whether or not the item is to be repaired and identifies the lowest maintenance level with the capability to do complete repair (i.e., perform all authorized repair functions.) Some limited repair may be done on the item at a lower level of maintenance, if authorized by the Maintenance Allocation Chart (MAC) and SMR code. This position will contain one of the following maintenance codes.

MAINTENANCE CODE	APPLICATION/EXPLANATION
O -	Organizational (or aviation unit) is the lowest level that can do complete repair of the item.
F -	Direct support (or aviation intermediate) is the lowest level that can do complete repair of the item.

**MAINTENANCE CODE - Continued****APPLICATION/ EXPLANATION - Continued**

H -	General support is the lowest level that can do complete repair of the item.
L -	Specialized repair activity (designate the specialized repair activity) is the lowest level that can do complete repair of the item.
D -	Depot is the lowest level that can do complete repair of the item.
Z -	Non-repairable. No repair is authorized.
B -	No repair is authorized. (No parts or special tools are authorized for the maintenance of a B-coded item.) However, the item may be reconditioned by adjusting, lubricating, etc., at the user level.

**Recoverability code.** Recoverability codes are assigned to items to indicate the disposition action on unserviceable items. The recoverability code is entered in the **fifth position** of the SMR code as follows:

**RECOVERABILITY CODE****APPLICATION/EXPLANATION**

Z -	Non-repairable item. When unserviceable, condemn and dispose of the item at the level of maintenance shown in the 3 <sup>rd</sup> position of the SMR Code.
O -	Repairable item. When uneconomically repairable, condemn and dispose of the item at organizational or aviation unit level.
F -	Repairable item. When uneconomically repairable, condemn and dispose of the item at the direct support or aviation intermediate level.
H -	Repairable item. When uneconomically repairable, condemn and dispose of the item at the general support level.
D -	Repairable item. When beyond the lower level repair capability, return to depot. Condemnation and disposal of item not authorized below depot level.



**RECOVERABILITY CODE - Continued****APPLICATION/EXPLANATION - Continued**

L -

Repairable item. Condemnation and disposal not authorized below Specialized Repair Activity (SRA).

A -

Item requires special handling or condemnation procedures because of specific reasons (e.g., precious metal content, high dollar value, critical material or hazardous material). Refer to appropriate manuals/directives for specific instructions.

**Column 3, CAGE Code.** The Commercial and Government Entity Code (CAGEC) is a 5-digit numeric code that is used to identify the manufacturer, distributor, or Government agency that supplies the item.

**Column 4, Part Number.** Indicates the primary number used by the manufacturer (individual, company, firm, corporation, or Government activity), which controls the design and characteristics of the item by means of its engineering drawings, specifications, standards, and inspection requirements to identify an item or range of items.

---

**NOTE**

---

When you use an NSN to requisition an item, the item you receive may have a different part number from the part ordered.

**Column 5, Description and Usable on Code (UOC).** This column includes the following information:

1. The Federal item name and, when repaired, a minimum description to identify the item.
2. The physical security classification of the item is indicated by the parenthetical entry, (insert applicable physical security classification abbreviation, e.g., Phy Sec CI (C) – Confidential, Phy Sec CI (S) Secret, Phy Sec CI (T) – Top Secret.
3. Items that are included in kits and sets are listed below the name of the kit or set.
4. Spare/repair parts that make up an assembled item are listed immediately following the assembled item line entry.
5. Part numbers for bulk materials are referenced in this column in the line item entry for the item to be manufactured/fabricated.
6. When the item is not used will all serial numbers of the same model, the effective serial numbers are shown on the last line(s) of the description (before UOC).
7. The usable on code, when applicable (see the “SPECIAL INFORMATION” paragraph below).
8. In the Special Tools List section, the Basis of Issue (BOI) appears as the last line(s) in the entry for each special tool, special TMDE, and other special support equipment. When density of equipment supported exceeds density spread indicated in the BOI, the total authorization is increased proportionately.

- The statement END OF FIGURE appears just below the last item description in Column 5 for a given figure.

**Column 6, QTY.** The QTY (quantity per figure column) indicates the quantity of the item used in the breakout shown on the illustration figure, which is prepared for a functional group, sub functional group, or an assembly. A “V” appearing in the column, in lieu of a quantity, indicates that the quantity is variable and may vary from application to application.

**SPECIAL INFORMATION**

The Usable on Code title appears in the lower right corner of column (5), Description. Usable on codes are shown in the right-hand margin of the description column.

Bulk materials required to manufacture items are listed in the Bulk Material group of this manual. NSNs for bulk materials are also referenced in the description column of the line item entry for the item to be manufactured/fabricated. Detailed manufacturing instructions for items source coded to be manufactured or fabricated are found in this manual.

Detailed assembly instructions for items source coded to be assembled from component spare/repair parts are found in this manual. Items that make up the assembly are listed immediately following the assembled item entry.

Line item entries for repair part kits and sets appear as the last entries in the repair part listing for the figure in which their parts are listed as repair parts.

Items that have the word Bulk in the figure number column will have an index number shown in the item number column. This index number is furnished for use as a cross-reference between the National Stock Number/Part Number Index and the bulk material list.

In the repair parts list, some items are indented to show that they are components of the item under which they are indented.

**EXPLANATION OF COLUMNS**

**National Stock Number (NSN) Index.**

- Stock number column. This column lists the NSN by National Item Identification Number (NIIN) sequence. The NIIN consists of the last nine digits of the NSN, i.e.

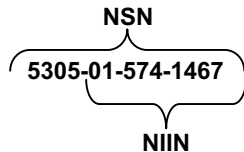

When using this column to locate an item, ignore the first 4 digits of the NSN. However, the complete NSN should be used when ordering items by stock number.

- Fig. column. This column lists the number of the figure where the item is identified/located.
- Item column. The item number identifies the item associated with the figure listed in the adjacent Fig. column. This item is also identified by the NSN listed on the same line.

**Part Number Index.** Part numbers in this index are listed by part number in ascending alphanumeric sequence (i.e., vertical arrangement of letter and number combination which places the first letter or digit of each group in order A through Z, followed by the numbers 0 through 9, and each following letter or digit in like order).

1. CAGEC column. The Commercial and Government Entity Code is a 5-digit numeric code used to identify the manufacturer, distributor, or Government agency, etc., that supplies the item.
2. Part number column. Indicates the primary number used by the manufacturer (individual, firm, corporation, or Government activity) that controls the design and characteristics of the item by means of its engineering drawings, specifications, standards, and inspection requirements to identify an item or range of items.
3. Stock number column. This column lists the NSN for the associated part number and manufacturer identified in the part number and CAGEC columns to the left.
4. Fig. column. This column lists the number of the figure where the item is identified/located.
5. Item column. The item number is that number assigned to the item as it appears in the figure referenced in the adjacent figure number column.

## HOW TO LOCATE REPAIR PARTS

### When National Stock Number or Part Number is Not Known.

1. First. Using the table of contents, determine the functional group or sub-functional group to which the item belongs. This is necessary since the figures are prepared for functional groups and sub-functional groups, and listings are divided into the same groups.
2. Second. Find the item on the figure covering the functional group or sub-functional group to which the item belongs.
3. Third. Identify the item on the figure and note the item number of the item.
4. Fourth. Refer to the Repair Parts List for the figure to find the line item entry for the item number noted on the figure.

### When National Stock Number or Part Number is Known.

1. First. Using the Index of National Stock Numbers and Part Numbers, find the pertinent National Stock Number or part number. The NSN index is in the National Item Identification Number (NIIN) \*sequence. The part numbers in the Part Number index are listed in ascending alphanumeric sequence. Both indexes cross-reference you to the illustration figure and item number of the item you are looking for.

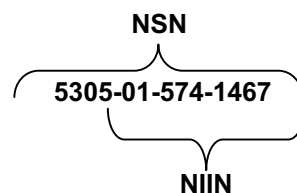

\*The NIIN consists of the last 9 digits of the NSN, as shown above.

2. Second. After finding the figure and item number, verify that the item is the one you're looking for, then locate the item number in the repair parts list for the figure.

**END OF WORK PACKAGE**



GROUP 00 MC-4 RAM AIR FREE-FALL PERSONNEL PARACHUTE SYSTEM

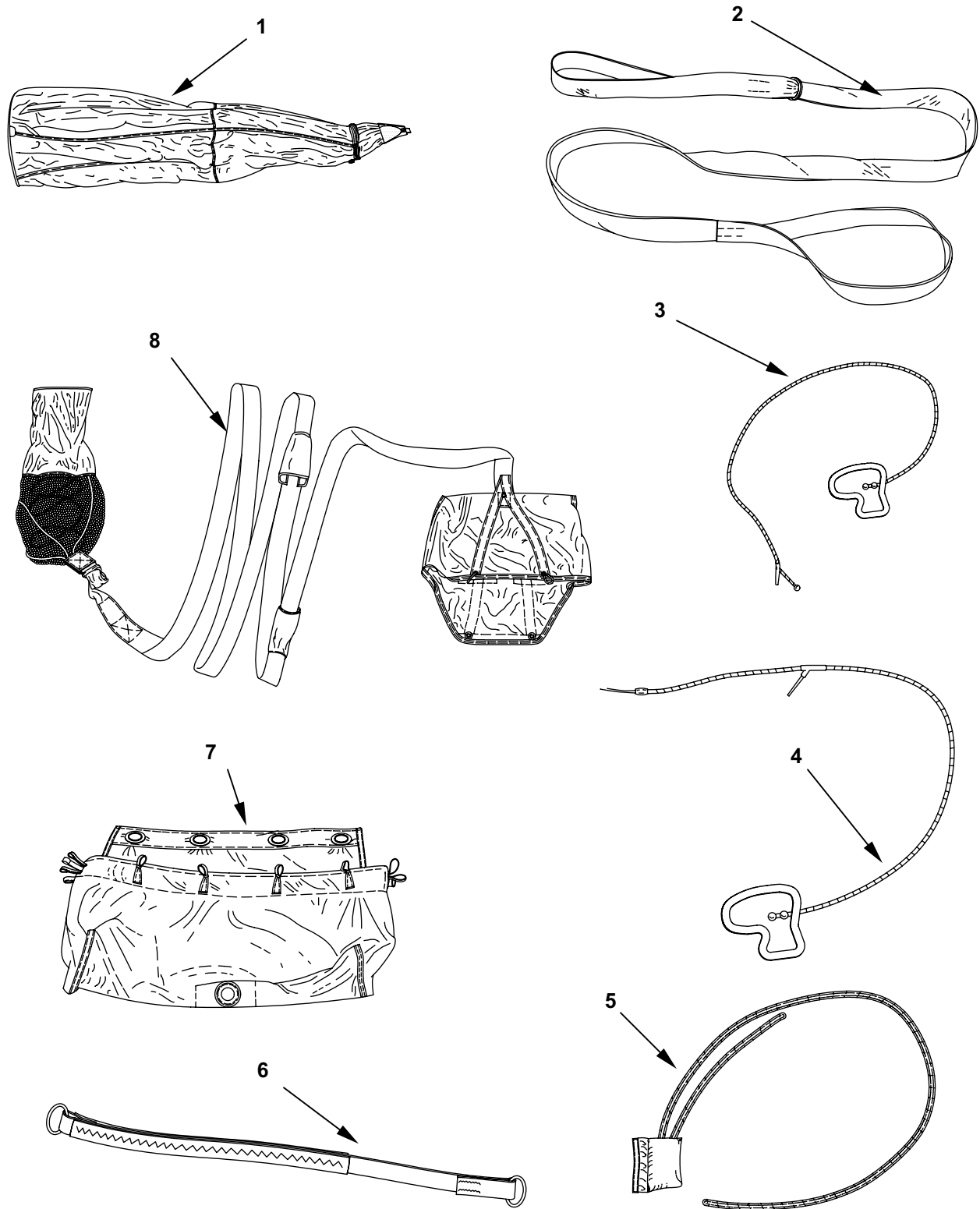

Figure 1. MC-4 Ram Air Free-Fall Personnel Parachute System (Sheet 1 of 3)

GROUP 00 MC-4 RAM AIR FREE-FALL PERSONNEL PARACHUTE SYSTEM

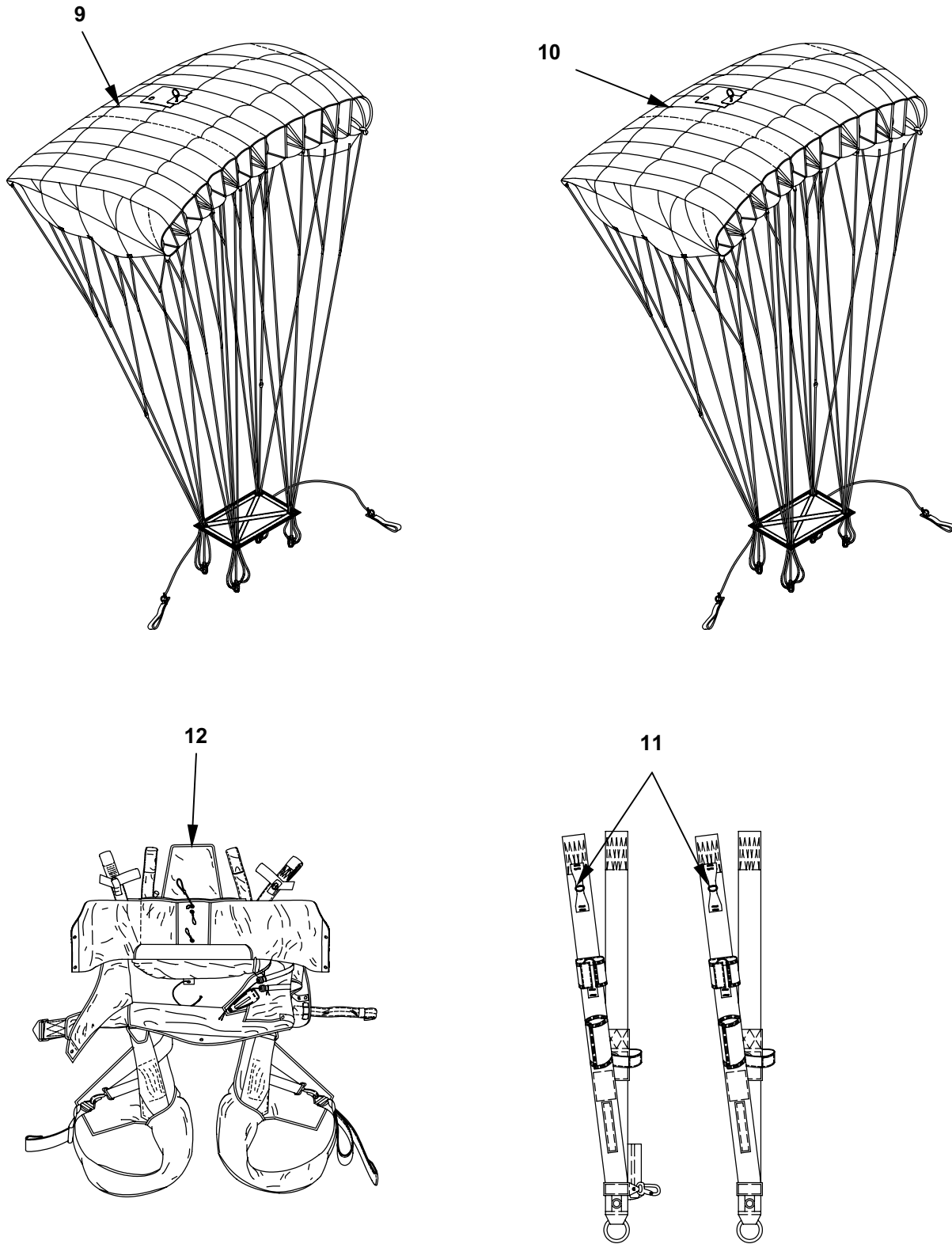

Figure 1. MC-4 Ram Air Free-Fall Personnel Parachute System (Sheet 2 of 3)

GROUP 00 MC-4 RAM AIR FREE-FALL PERSONNEL PARACHUTE SYSTEM

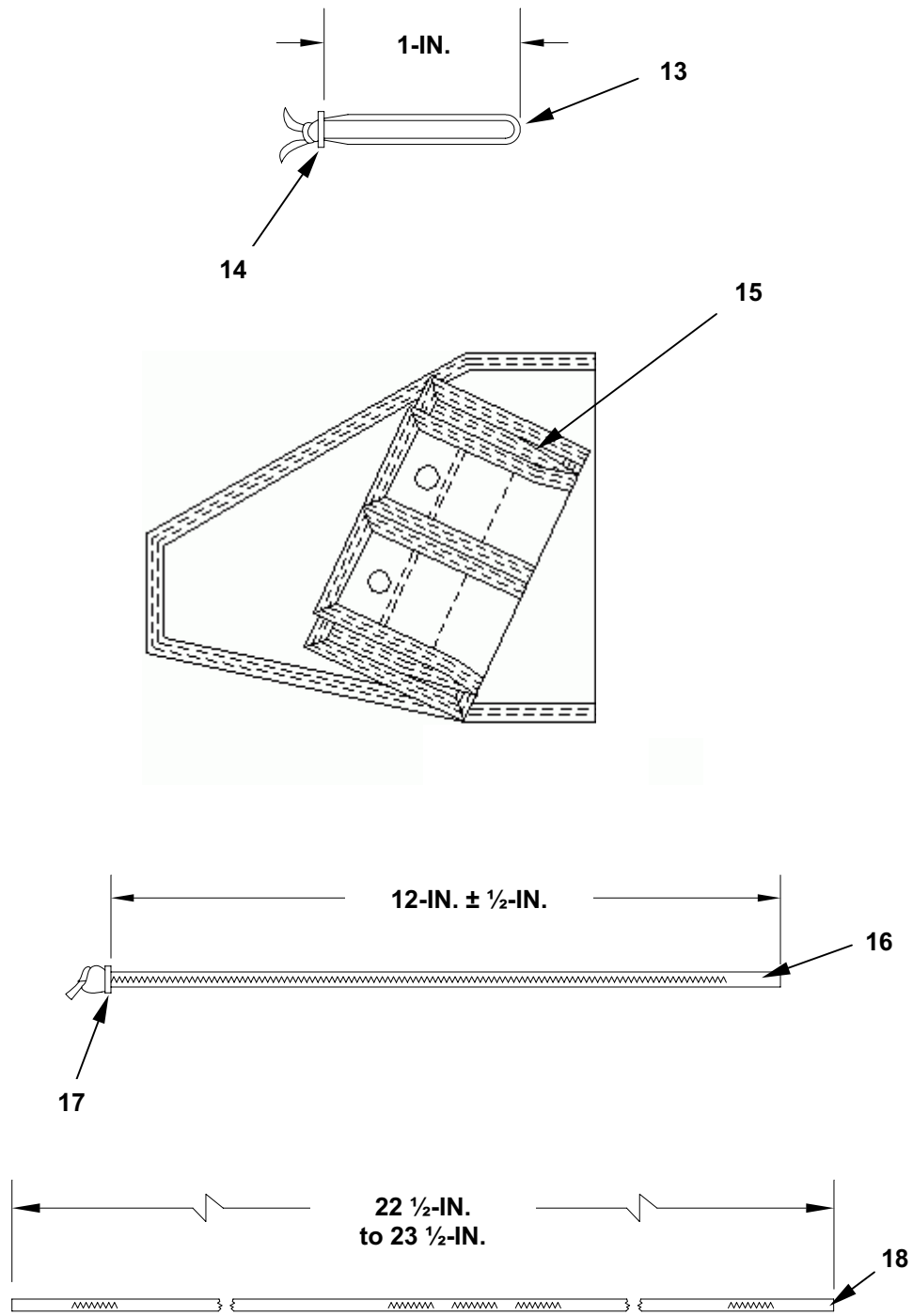

Figure 1. MC-4 Ram Air Free-Fall Personnel Parachute System (Sheet 3 of 3)



**GROUP 00 MC-4 RAM AIR FREE-FALL PERSONNEL PARACHUTE SYSTEM  
REPAIR PARTS LIST**

(1) ITEM NO.	(2) SMR CODE	(3) NSN	(4) CAGEC	(5) PART NO.	(6) DESCRIPTION AND USABLE ON CODES (UOC)	(7) QTY
Group 00, Parachute System, MC-4 Figure 1, Parachute System, Ram Air, MC-4 11-1-3516						
1	PAOOO	1670-01-330-3747	81337	11-1-3522-1	Pilot Chute Assembly, Main	1
2	PAOZZ	1670-01-330-3283	81337	11-1-3523-1	Bridle Assembly, Pilot Chute, Main	1
3	PAOZZ	1670-01-330-3282	81337	11-1-3524-2	Ripcord Assembly, Main	1
4	PAOZZ	1670-01-330-3281	81337	11-1-3525	Ripcord Assembly, Reserve	1
5	PAOZZ	1670-01-330-3743	81337	11-1-3526-1	Ripcord Assembly, Main Release	1
6	PAOZZ	1670-01-330-3738	81337	11-1-3527-1	Static Line Assembly, Reserve	1
7	PAOOO	1670-01-334-7597	81337	11-1-3521-1	Deployment Bag Assembly, Main	1
8	PAOZZ	1670-01-342-7686	81337	11-1-3520-1	Deployment System, Reserve	1
9	PAOOO	1670-01-332-3916	81337	11-1-3518-0	Parachute Assembly, Main Parachute	1
10	PAOOO	1670-01-330-3279	81337	11-1-3518-1	Parachute Assembly, Reserve Parachute	1
11	PAOOO	1670-01-330-3284	81337	11-1-3519-1	Riser Set, 3-Ring, Main	1
12	PAOOO	1670-01-330-3280	81337	11-1-3517-1	Harness/Container Assembly	1

**GROUP 00 MC-4 RAM AIR FREE-FALL PERSONNEL PARACHUTE SYSTEM  
REPAIR PARTS LIST**

(1) ITEM NO.	(2) SMR CODE	(3) NSN	(4) CAGEC	(5) PART NO.	(6) DESCRIPTION AND USABLE ON CODES (UOC)	(7) QTY
13	PAOZZ	1670-01-487-6077	81337	11-1-3530-1	Loop, Locking, Elastic	1
14	XDOZZ		Commercial	929174160	Washer, Flat #14L, Nickel Plated, Brass or Equal	1
15	PAOZZ	1670-01-475-1207	81337	11-1-4235-1	Pocket Assembly, Padded, AR2	1
16	PAOZZ	1670-01-330-3741	81337	11-1-3528-1	Loop, Closing, Main, 12- IN. ± ½-IN.	1
17	XDOZZ		Commercial	92917A140	Washer, Flat, Nickel Plated, Brass or Equal, ID 0.2-IN., OD 0.5-IN., Thickness 0.04-IN.	1
18	PAOZZ	1670-01-330-3742	81337	11-1-3529-1	Loop, Closing, Reserve, 22 ½-IN. to 23 ½-IN.	1
<b>END OF FIGURE</b>						



GROUP 01 MAIN DEPLOYMENT BAG

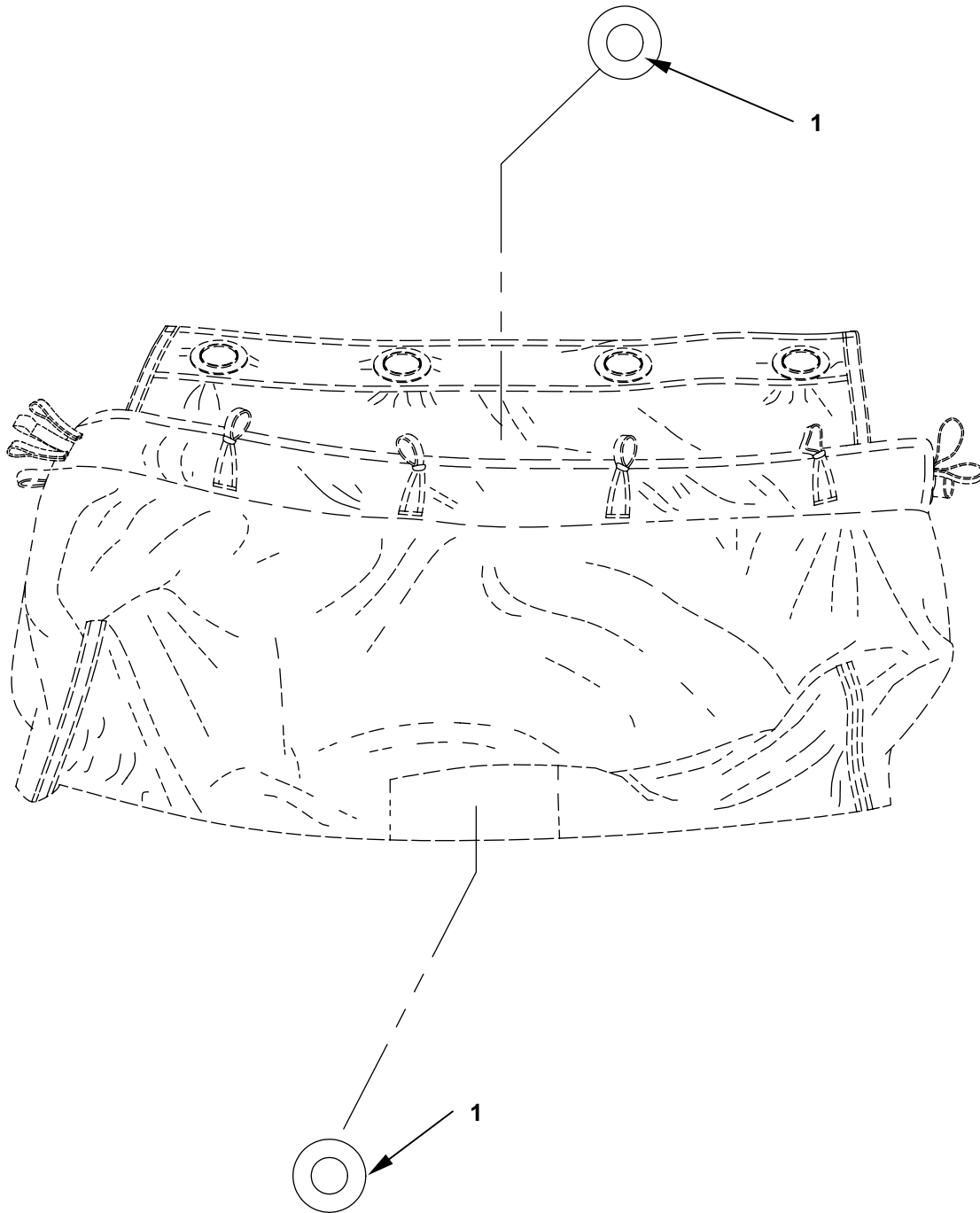

Figure 2. Main Deployment Bag

**GROUP 01 MAIN DEPLOYMENT BAG  
REPAIR PARTS LIST**

(1) ITEM NO.	(2) SMR CODE	(3) NSN	(4) CAGEC	(5) PART NO.	(6) DESCRIPTION AND USABLE ON CODES (UOC)	(7) QTY
Group 01, Deployment Bag. Main Figure 2, Deployment Bag, Main 11-1-3521						
1	PAOZZ	5325-01-506-7568	81349	NASM16491	Grommet, Rolled Rim and Spur No. 5, Type III, Class II	1
<b>END OF FIGURE</b>						





GROUP 02 RESERVE DEPLOYMENT SYSTEM

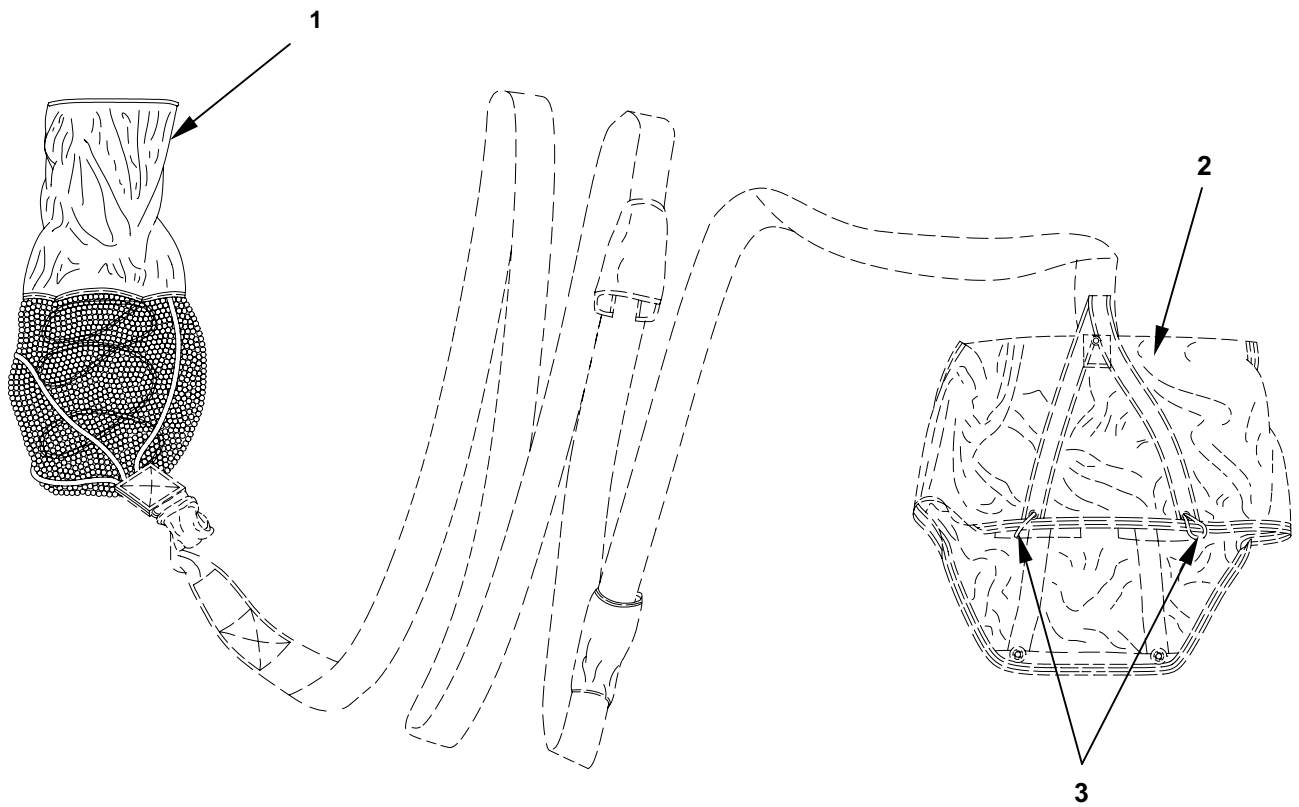

Figure 3. Reserve Deployment System



**GROUP 02 RESERVE DEPLOYMENT SYSTEM  
REPAIR PARTS LIST**

(1) ITEM NO.	(2) SMR CODE	(3) NSN	(4) CAGEC	(5) PART NO.	(6) DESCRIPTION AND USABLE ON CODES (UOC)	(7) QTY
Group 02, Deployment System, Reserve Figure 3, Deployment System, Reserve 11-1-3520						
1	PAOZZ	1670-01-331-5423	81337	11-1-3545-1	Pilot Chute Assembly, Reserve	1
2	PAOZZ	1670-01-330-3748	81337	11-1-3544-1	Deployment Bag and Bridle Assembly, Reserve	1
3	PAOZZ	1670-01-330-3740	81337	11-1-3533-1	Loop Assembly, Safety Stow	1
<b>END OF FIGURE</b>						





GROUP 03 MAIN CANOPY

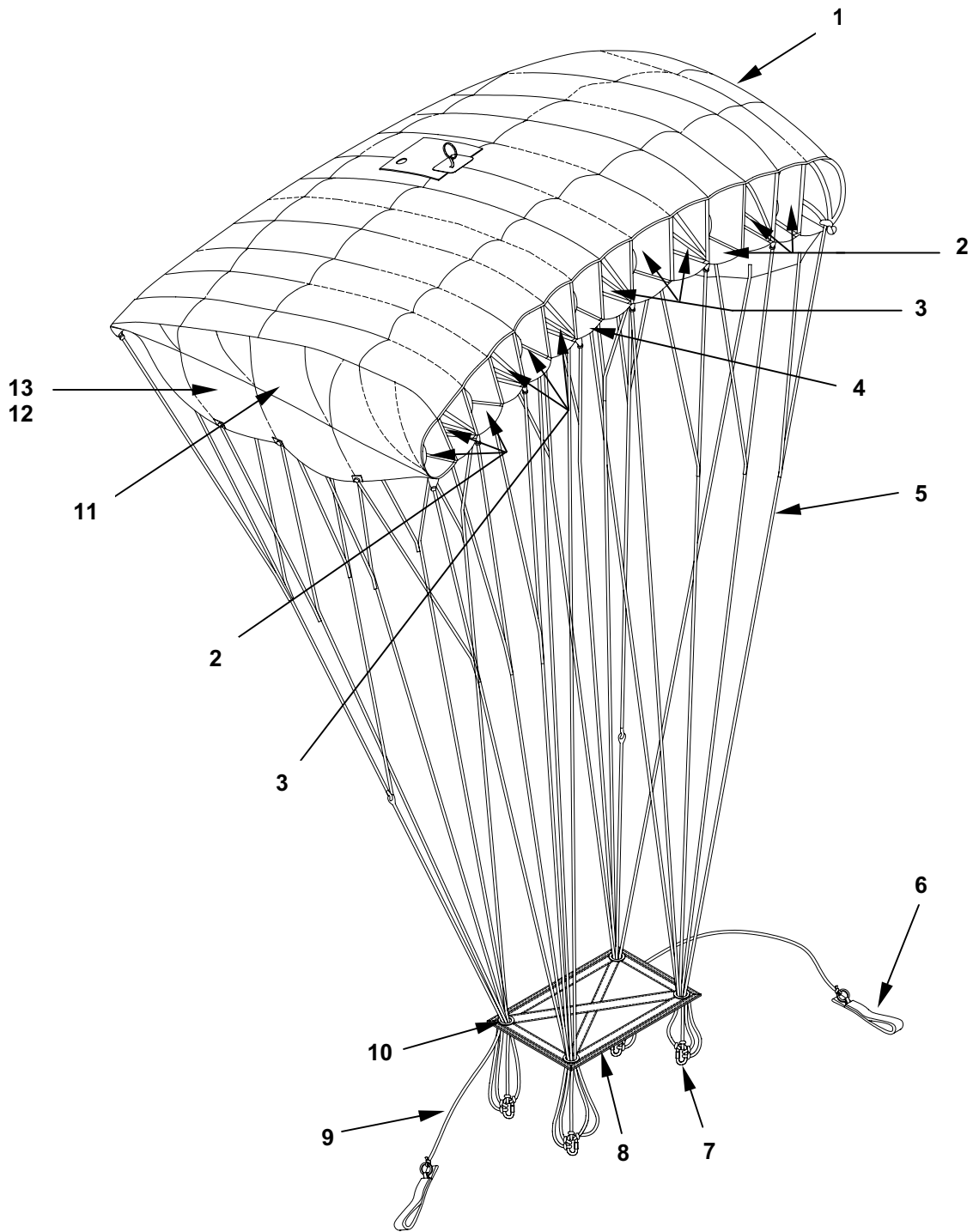

Figure 4. Main Canopy

**GROUP 03 MAIN CANOPY  
REPAIR PARTS LIST**

(1) ITEM NO.	(2) SMR CODE	(3) NSN	(4) CAGEC	(5) PART NO.	(6) DESCRIPTION AND USABLE ON CODES (UOC)	(7) QTY
Group 03, Canopy, Main Figure 4, Canopy, Main 11-1-3518-0						
1	XDFFO		81337	11-1-3419-1	Rib, Loaded, Left	1
2	XDFFO		81337	11-1-3419-4	Rib, Unloaded	6
3	XDFFO		81337	11-1-3419-5	Rib, Loaded	6
4	XDFFO		81337	11-1-3419-3	Rib, Loaded, Center	1
5	PAFZZ	1670-01-330-3746	81337	11-1-3699-1	Suspension Line Set	1
6	PAOZZ	1670-01-342-5135	81337	11-1-3532-1	Toggle Assembly, Soft	2
7	PAOZZ	1670-01-330-3691	63266	HSS358-6	Link, Connector, Stainless Steel #6 or equal	4
8	PAOOO	1670-01-330-3744	81337	11-1-3531-1	Slider Assembly Domed, 27-IN. by 28- IN.	1
9	PAFZZ	1670-01-330-3745	81337	11-1-3700-0	Control Line Assembly, Main, Set	1
10	XDOZZ		57771	Commercial	Grommet, Rolled Rim and Spur Grommet, Size 8, Nickel Plated Brass	4

**GROUP 03 MAIN CANOPY  
REPAIR PARTS LIST**

(1) ITEM NO.	(2) SMR CODE	(3) NSN	(4) CAGEC	(5) PART NO.	(6) DESCRIPTION AND USABLE ON CODES (UOC)	(7) QTY
11	XDOZZ		81337	11-1-3419-2	Rib, Loaded, Right	1
12	XDFFO		81337	11-1-3418-2	Panel, Stabilizer, Right	1
13	XDFFO		81337	11-1-3418-1	Panel, Stabilizer, Left	1
<b>END OF FIGURE</b>						



GROUP 04 RESERVE CANPOY

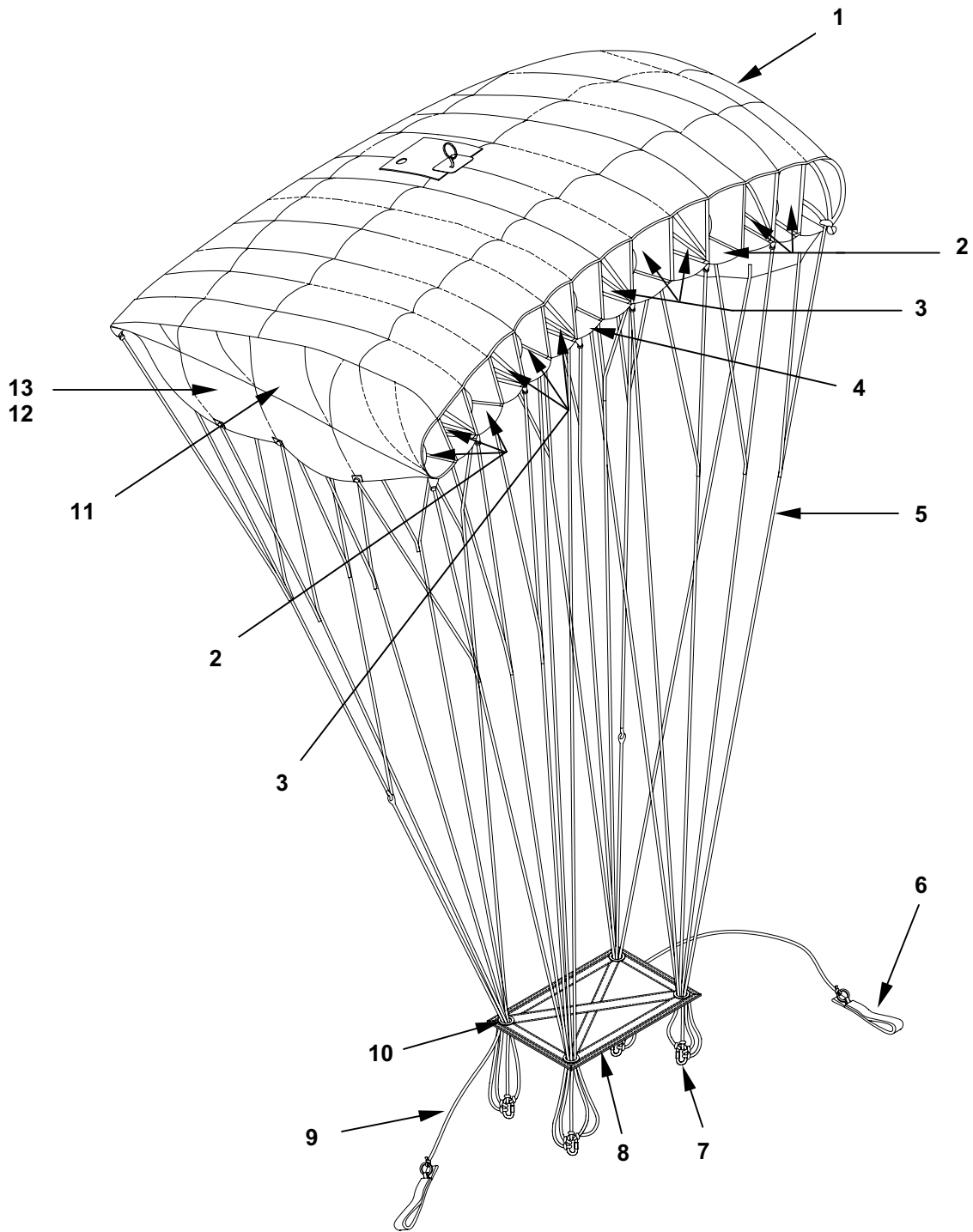

Figure 5. Reserve Canopy



**GROUP 04 RESERVE CANOPY  
REPAIR PARTS LIST**

(1) ITEM NO.	(2) SMR CODE	(3) NSN	(4) CAGEC	(5) PART NO.	(6) DESCRIPTION AND USABLE ON CODES (UOC)	(7) QTY
Group 04, Canopy, Reserve Figure 5, Canopy, Reserve 11-1-3518-1						
1	XDFFO		81337	11-1-3419-1	Rib, Loaded, Left	1
2	XDFFO		81337	11-1-3419-4	Rib, Unloaded	6
3	XDFFO		81337	11-1-3419-5	Rib, Loaded	6
4	XDFFO		81337	11-1-3419-3	Rib, Loaded, Center	1
5	PAFZZ	1670-01-330-3746	81337	11-1-3699-1	Suspension Line Set	1
6	PAOZZ	1670-01-342-5135	81337	11-1-3532-1	Toggle Assembly, Soft	2
7	PAOZZ	1670-01-330-3691	63266	HSS358-6	Link, Connector, Stainless Steel #6 or equal	4
8	PAOOO	1670-01-330-3744	81337	11-1-3531-1	Slider Assembly Domed, 27-IN. by 28-IN.	1
9	PAFZZ	1670-01-503-9820	81337	11-1-3700-1	Control Line Assembly, Reserve, Set	1
10	XDOZZ		57771	Commercial	Grommet, Rolled Rim and Spur Grommet, No. 8, Nickel Plated Brass	4

**GROUP 04 RESERVE CANOPY  
REPAIR PARTS LIST**

(1) ITEM NO.	(2) SMR CODE	(3) NSN	(4) CAGEC	(5) PART NO.	(6) DESCRIPTION AND USABLE ON CODES (UOC)	(7) QTY
11	XDOZZ		81337	11-1-3419-2	Rib, Loaded, Right	1
12	XDFFO		81337	11-1-3418-2	Panel, Stabilizer, Right	1
13	XDFFO		81337	11-1-3418-1	Panel, Stabilizer, Left	1
<b>END OF FIGURE</b>						



GROUP 05 MAIN RISERS

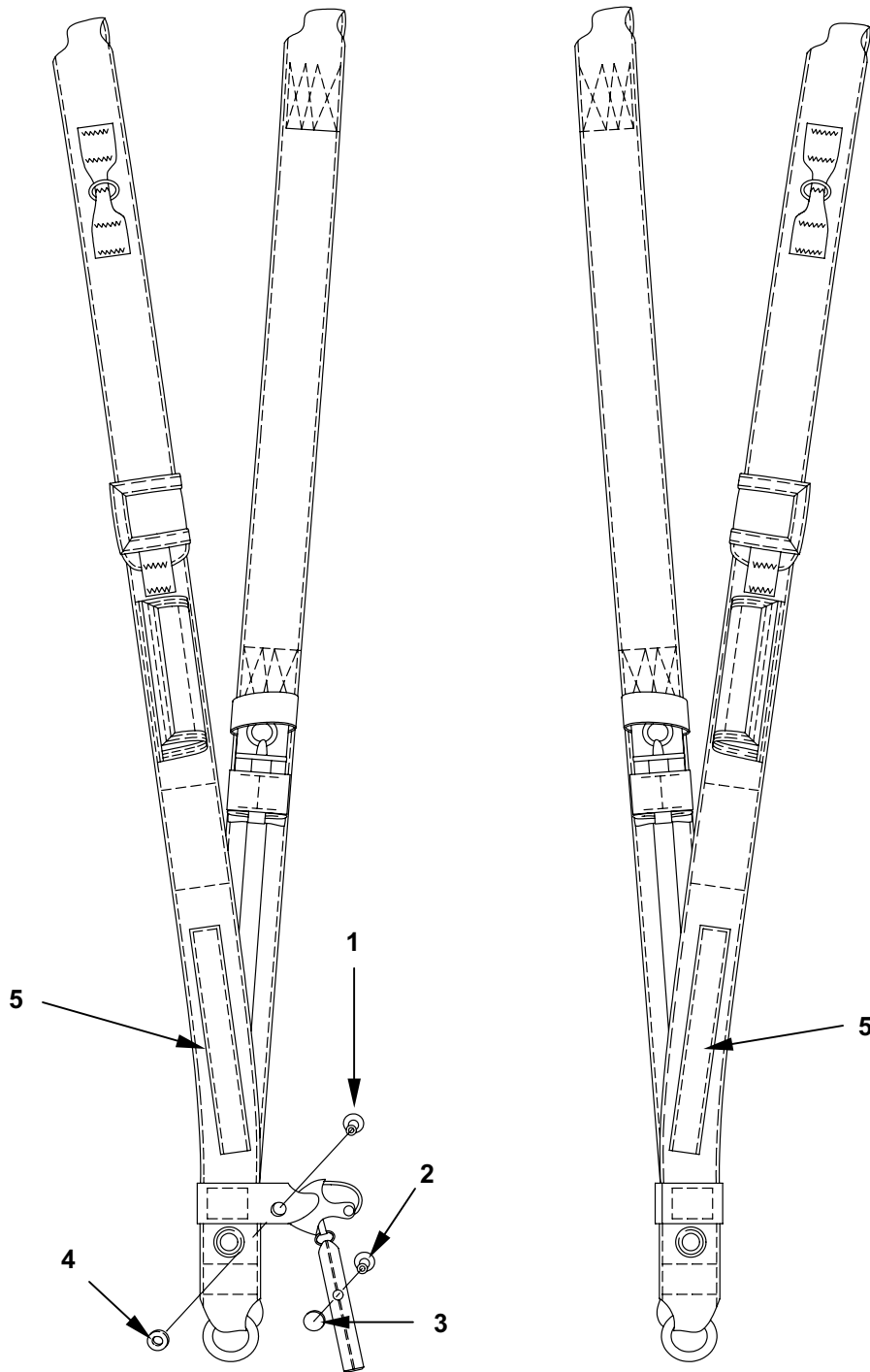

Figure 6. Main Risers

**GROUP 05 MAIN RISERS  
REPAIR PARTS LIST**

(1) ITEM NO.	(2) SMR CODE	(3) NSN	(4) CAGEC	(5) PART NO.	(6) DESCRIPTION AND USABLE ON CODES (UOC)	(7) QTY
Group 05, Risers, Main Figure 6, Risers, Main 11-1-3519						
1	PAOZZ	5325-00-842-1879	96906	MS27980-7B	Fastener, Snap, Style 2, Stud, Black	1
2	PAOZZ	5325-00-285-6250	96906	MS27980-6B	Fastener, Snap, Style 2, Socket, Black	1
3	PAOZZ	5325-00-359-6844	96906	MS27980-1B	Fastener, Snap, Style 2, Button, Black	1
4	PAOZZ	5325-01-023-3843	96906	MS27980-8B	Fastener, Snap, Style 2, Eyelet, Black	1
5	MOOOO		81349	PIA-T-5038	Channel, Main Canopy Release Cable, Make From Tape, Nylon, PIA- T-5038, Type III, Class I, 1-IN. Wide, Thread, Nylon, V-T-295, Size E	4
<b>END OF FIGURE</b>						



GROUP 06 HARNESS/CONTAINER

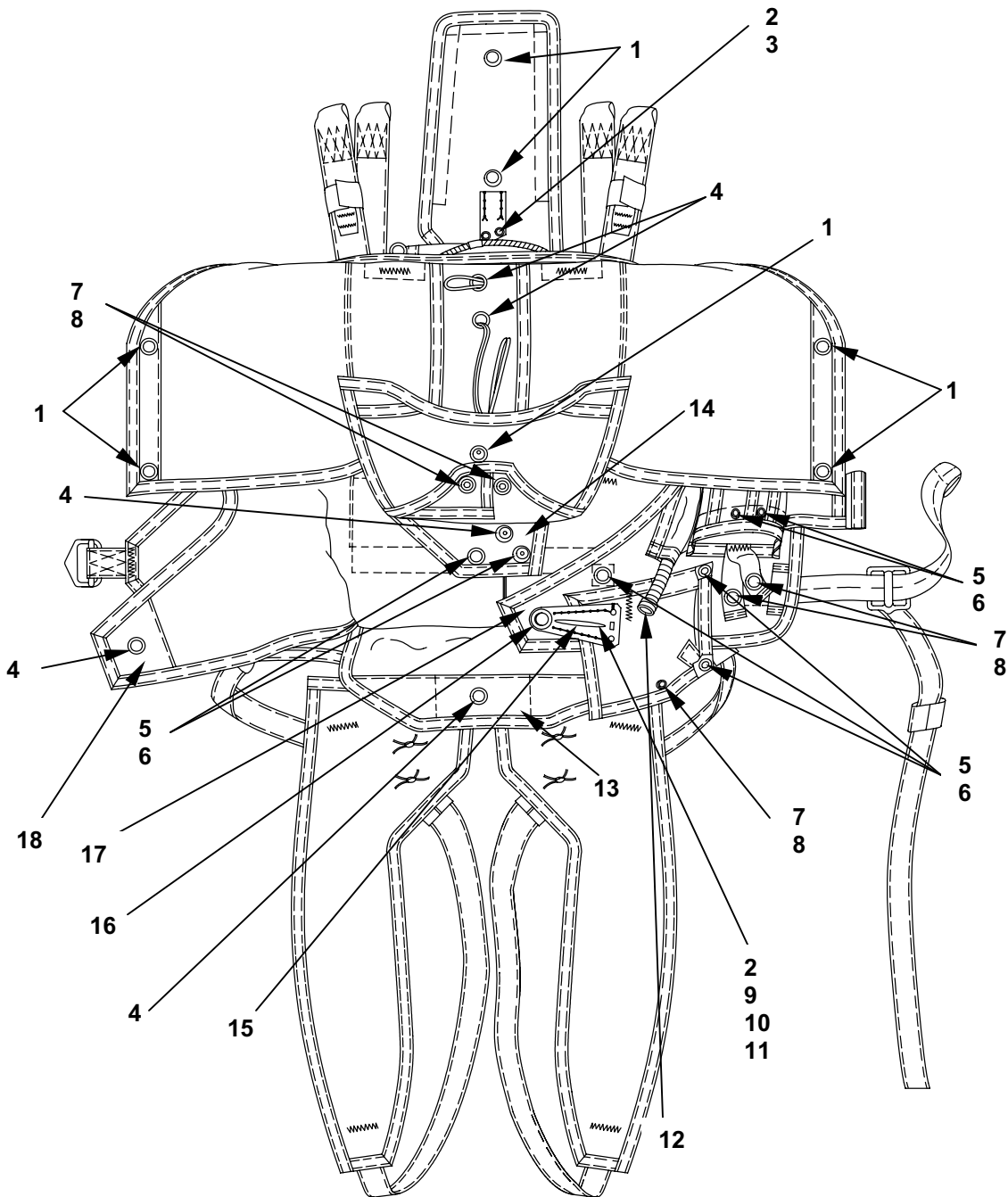
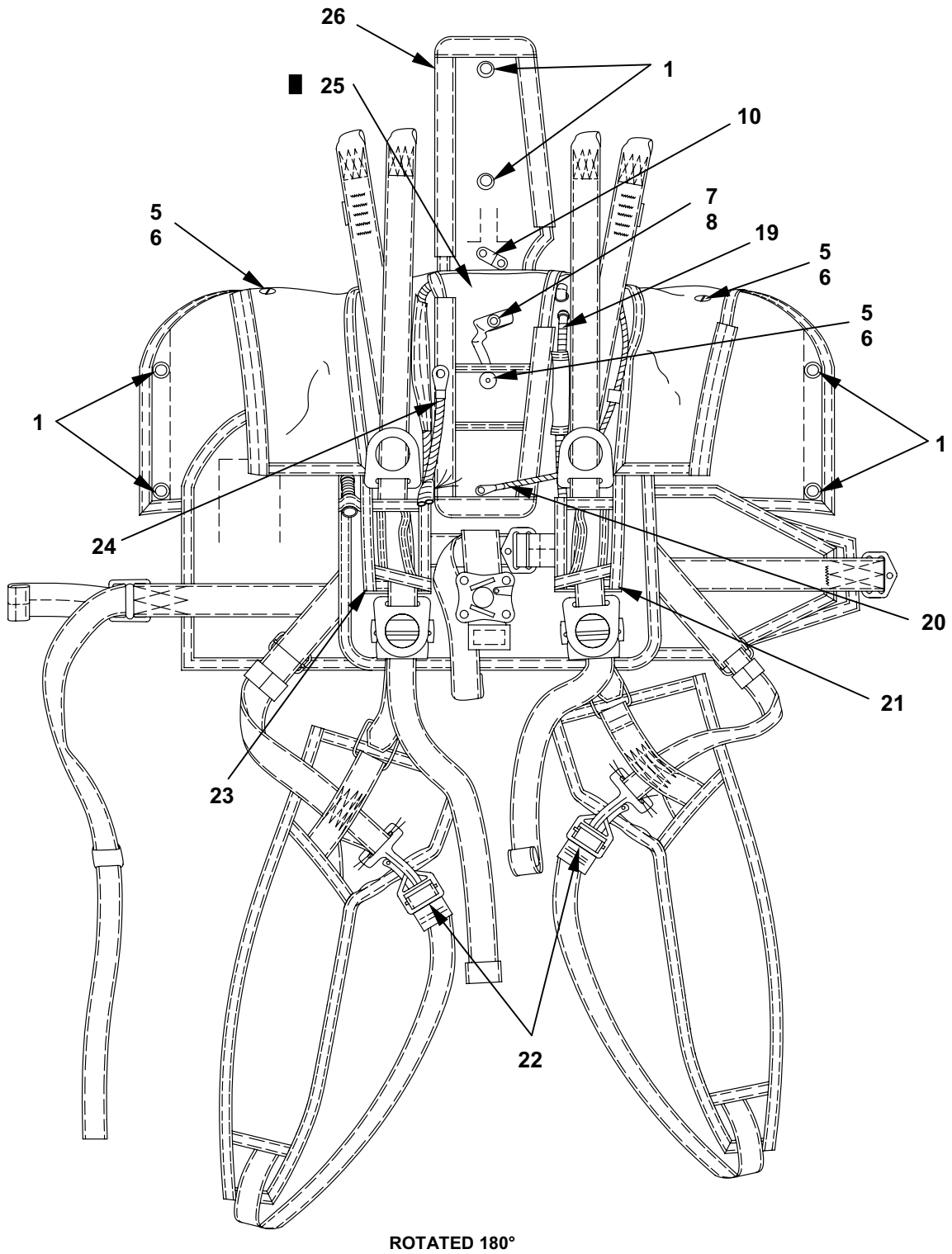

Figure 7. Harness/Container (Sheet 1 of 2)

GROUP 06 HARNESS/CONTAINER



■ Figure 7. Harness/Container (Sheet 2 of 2)



**GROUP 06 HARNESS/CONTAINER  
REPAIR PARTS LIST**

(1) ITEM NO.	(2) SMR CODE	(3) NSN	(4) CAGEC	(5) PART NO.	(6) DESCRIPTION AND USABLE ON CODES (UOC)	(7) QTY
Group 06, Harness/Container Figure 7, Harness/Container 11-1-3517						
1	PAOZZ	5325-01-506-9046	57771	#0 RRGSW305SS	Grommet, Rolled Rim/Spur Washer, 305 Stainless Steel, No. 0,	7
2	PAOZZ	5305-00-054-6651	96906	MS51957-27	Screw, Machine, Pan Head, Cross Recessed, AR2 Power Cable Mounting, Main and Reserve, Cres, UNC-2A (Not Shown)	4
3	PAOZZ	5310-00-176-6341	96906	MS17830-06C	Nut, AR2 Power Cable Mounting, Reserve Only	2
4	PAOZZ	5325-01-506-9046	57771	#0 RRGSW305SS	Grommet, Rolled Rim/Spur Washer, 305 Stainless Steel, No. 0,	4
5	PAOZZ	5325-00-842-1879	96906	MS27980-7B	Fastener, Snap, Stud	10
6	PAOZZ	5325-01-023-3843	96906	MS27980-8B	Fastener, Snap, Eyelet	10
7	PAOZZ	5325-00-285-6250	96906	MS27980-6B	Fastener, Snap, Socket	10
8	PAOZZ	5325-00-359-6844	96906	MS27980-1B	Fastener, Snap, Button	10
9	PAOZZ	1670-01-504-1457	81337	11-1-4011-1	Plate, Backing, AR2 Main Mounted Only (Not Shown)	1
10	PAOZZ	1670-01-503-9819	81337	11-1-4010-1	Clamp, AR2 Power Cable Mounting, Main/Reserve (Not Shown)	2
11	PAOZZ	5310-00-925-9646	96906	MS21083C06	Nut, AR2 Power Cable Mounting, Main Only (Not Shown)	2

## GROUP 06 HARNESS/CONTAINER

(1) ITEM NO.	(2) SMR CODE	(3) NSN	(4) CAGEC	(5) PART NO.	(6) DESCRIPTION AND USABLE ON CODES (UOC)	(7) QTY
12	XBOZZ		81337	PS70104	Housing, Ripcord, Main, 33-IN.	1
13	PAOZZ	1670-01-504-1461	81337	11-1-3553-1	Stiffener, Main Bottom Flap	1
14	PAOZZ	1670-01-504-1456	81337	11-1-3590-1	Stiffener, Main Top Flap	1
15	PAOZZ	1670-01-503-9821	81337	11-1-3565-1	AAD Junction Plate, Main	1
16	PAOZZ	5325-01-506-9030	57771	#2 RRGSW305SS	Grommet, Rolled Rim/Spur Washer 305 Stainless Steel, No. 2	1
17	PAOZZ	1670-01-504-1459	81337	11-1-3591-2	Stiffener, Main, Right Side Flap	1
18	PAOZZ	1670-01-504-1460	81337	11-1-3591-1	Stiffener, Main, Left Side Flap	1
19	XBOZZ		81337	PS70104	Housing, Ripcord, Reserve, 11-IN.	1
20	XBOZZ		81337	11-1-3551-1	Housing, Main Release, Long, 41-IN.	1
21	PAOZZ	1670-01-343-2946	81337	11-1-3567-1	Pocket, Reserve Ripcord	1
22	XBOZZ		96906	MS70113-1	Ring, V, Quick Fit	2

**GROUP 06 HARNESS/CONTAINER  
REPAIR PARTS LIST**

(1) ITEM NO.	(2) SMR CODE	(3) NSN	(4) CAGEC	(5) PART NO.	(6) DESCRIPTION AND USABLE ON CODES (UOC)	(7) QTY
23	PAOZZ	1670-01-342-7696	81337	11-1-3568-1	Pocket, Main Ripcord	1
24	XBOZZ		81337	11-1-3551-0	Housing, Main Release, Short, 5 ½-IN.	1
25	PAOZZ	1670-01-504-1458	81337	11-1-3697-1	Stiffener, Reserve Closing Flap	1
26	XDOZZ		81337	11-1-3574-1	Flap Assembly, Reserve	1
<b>END OF FIGURE</b>						





**GROUP 99 BULK MATERIALS  
REPAIR PARTS LIST**

(1) ITEM NO.	(2) SMR CODE	(3) NSN	(4) CAGEC	(5) PART NO.	(6) DESCRIPTION AND USABLE ON CODES (UOC)	(7) QTY
<b>Group 99, Bulk Materials</b>						
1	PAOZZ	8305-01-506-0532	81349	MIL-C-43734	Cloth, Duck, Textured Nylon, Class 3, CG 483	V
2	PAOZZ	8305-01-315-7955	81349	PIA-C-44378	Cloth, Nylon, Ripstop, Type I, Color 26270 of FED-STD-595	V
3	PAOZZ	8305-00-765-2863	81349	PIA-C-7219	Cloth, Nylon, Type III, Class 3, Black	V
4	PAOZZ	1670-01-359-9485	81348	T-C-2754	Cord, Dacron, 600-Pound, Type I	V
5	PAOZZ	8315-00-106-5973	58536	A-A-55126	Fastener, Tape, Hook, 1-IN. Wide, Type II, Class 1	V
6	PAOZZ	8315-00-106-5974	58536	A-A-55126	Fastener, Tape, Pile, 1-IN. Wide, Type II, Class 1	V
7	PAOZZ	8315-00-151-6482	58536	A-A-55126	Fastener, Tape, Pile, 2-IN. Wide, Type II, Class 1	V
8	XDOZZ			Commercial	Style Force 9, 1.9-OZ, Ripstop, 2-IN. Wide, Color White	V
9	PAOZZ	8315-01-506-5694	81349	MIL-PRF-5038	Tape, Textile and Webbing, <sup>3</sup> / <sub>8</sub> -IN., Gray, 26270	V
10	PAOZZ	4020-00-753-6555	80244	A-A-52080	Tape, Lacing and Tying, Type I, Finish B, Size 3, Black	RL
11	PAOOZ	8315-01-506-4404	81349	MIL-T-5038	Tape, Nylon, Gray, 1-IN. Wide, Class 2, Color 26270 of FED-STD-595	V

**GROUP 99 BULK MATERIALS  
REPAIR PARTS LIST**

(1) ITEM NO.	(2) SMR CODE	(3) NSN	(4) CAGEC	(5) PART NO.	(6) DESCRIPTION AND USABLE ON CODES (UOC)	(7) QTY
<b>Group 99, Bulk Materials</b>						
12	PAOZZ	8315-01-506-8812	81349	MIL-T-5608	Tape, Nylon, 2-IN. Wide	V
13	PAOZZ	8315-00-176-8083	81349	PIA-T-5038	Tape, Nylon, Type III, Class I, 3/4-IN. Wide	V
14	PAOZZ	8310-00-261-9741	81348	A-A-50294	Thread, Cotton, Size 24/4	TU
15	PAOZZ	8310-00-262-3324	81348	V-T-295	Thread, Nylon, Size A	TU
16	PAOZZ	8310-00-262-2772	81348	V-T-295	Thread, Nylon, Size E, Green, CG-483, Class A, Types I, II, or III	TU
17	PAOZZ	8310-00-262-2770	81348	V-T-295	Thread, Nylon, Size E, Natural, Class A, Types I, II, or III	TU
18	PAOZZ	8310-00-277-1244	81348	V-T-295	Thread, Nylon, Size FF, CG-483, Class A, Types I, II, or III	TU
19	PAOZZ	8305-00-270-1894	81349	MIL-W-5664	Webbing, Elastic, 1-In.	V
20	PAOZZ	8305-00-263-3592	81349	PIA-W-4088	Webbing, Textile, Nylon, Type II, CG 483	V
<b>END OF FIGURE</b>						





---

**MC-4 RAM AIR FREE-FALL PERSONNEL PARACHUTE SYSTEM  
SPECIAL TOOLS LIST**

---

*Not Applicable*

**END OF WORK PACKAGE**



**MC-4 RAM AIR FREE-FALL PERSONNEL PARACHUTE SYSTEM  
NATIONAL STOCK NUMBER INDEX**

NATIONAL STOCK NUMBER INDEX		
STOCK NUMBER	FIGURE	ITEM
8315-01-506-8812	BULK	12
5325-01-023-3843	6	4
5325-01-023-3843	7	6
5305-00-054-6651	7	2
8315-00-106-5973	BULK	5
8315-00-106-5974	BULK	6
8315-00-151-6482	BULK	7
5310-00-176-6341	7	3
8315-00-176-8083	BULK	13
8310-00-261-9741	BULK	14
8310-00-262-2770	BULK	17
8310-00-262-2772	BULK	16
8310-00-262-3324	BULK	15
8305-00-263-3592	BULK	20
8305-00-270-1894	BULK	19
8310-00-277-1244	BULK	18
5325-00-285-6250	6	2
5325-00-285-6250	7	7
8305-01-315-7955	BULK	2
1670-01-330-3279	1	10
1670-01-330-3280	1	12
1670-01-330-3281	1	4
1670-01-330-3282	1	3
1670-01-330-3283	1	2
1670-01-330-3284	1	11
1670-01-330-3691	4	7
1670-01-330-3691	5	7
1670-01-330-3738	1	6
1670-01-330-3740	3	3
1670-01-330-3741	1	16
1670-01-330-3742	1	18
1670-01-330-3743	1	5
1670-01-330-3744	4	8
1670-01-330-3744	5	8
1670-01-330-3745	4	9
1670-01-330-3746	4	5

STOCK NUMBER	FIGURE	ITEM
1670-01-330-3746	5	5
1670-01-330-3747	1	1
1670-01-330-3748	3	2
1670-01-331-5423	3	1
1670-01-332-3916	1	9
1670-01-334-7597	1	7
1670-01-342-5135	4	6
1670-01-342-5135	5	6
1670-01-342-7686	1	8
1670-01-342-7696	7	23
1670-01-343-2946	7	21
5325-00-359-6844	6	3
5325-00-359-6844	7	8
1670-01-359-9485	BULK	4
1670-01-475-1207	1	15
1670-01-487-6077	1	13
1670-01-503-9819	7	10
1670-01-503-9820	5	9
1670-01-503-9821	7	15
1670-01-504-1458	7	25
1670-01-504-1456	7	14
1670-01-504-1457	7	9
1670-01-504-1459	7	17
1670-01-504-1460	7	18
1670-01-504-1461	7	13
8305-01-506-0532	BULK	1
8315-01-506-4404	BULK	11
8315-01-506-5694	BULK	9
5325-01-506-7568	2	1
5325-01506-9030	7	16
5325-01-506-9046	7	1
5325-01-506-9046	7	4
4020-00-753-6555	BULK	10
8305-00-765-2863	BULK	3
5325-00-842-1879	6	1
5320-00-842-1879	7	5
5310-00-925-9646	7	11

END OF WORK PACKAGE



**MC-4 RAM AIR FREE-FALL PERSONNEL PARACHUTE SYSTEM  
PART NUMBER INDEX**

PART NUMBER	FIGURE	ITEM
#0 RRGSW305SS	7	1
#0 RRGSW305SS	7	4
#2 RRGSW305SS	7	16
11-1-3418-1	4	13
11-1-3418-1	5	13
11-1-3418-2	4	12
11-1-3418-2	5	12
11-1-3419-1	4	1
11-1-3419-1	5	1
11-1-3419-2	4	11
11-1-3419-2	5	11
11-1-3419-3	4	4
11-1-3419-3	5	4
11-1-3419-4	4	2
11-1-3419-4	5	2
11-1-3419-5	4	3
11-1-3419-5	5	3
11-1-3517-1	1	12
11-1-3518-0	1	9
11-1-3518-1	1	10
11-1-3519-1	1	11
11-1-3520-1	1	8
11-1-3521-1	1	7
11-1-3522-1	1	1
11-1-3523-1	1	2
11-1-3524-2	1	3
11-1-3525	1	4
11-1-3526-1	1	5
11-1-3527-1	1	6
11-1-3528-1	1	16
11-1-3529-1	1	18
11-1-3530-1	1	13
11-1-3531-1	4	8
11-1-3531-1	5	8
11-1-3532-1	4	6
11-1-3532-1	5	6
11-1-3533-1	3	3
11-1-3544-1	3	2
11-1-3545-1	3	1
11-1-3551-0	7	24
11-1-3551-1	7	20
11-1-3553-1	7	13
11-1-3565-1	7	15
11-1-3567-1	7	21
11-1-3568-1	7	23
11-1-3574-1	7	26
11-1-3590-1	7	14
11-1-3591-1	7	18
11-1-3591-2	7	17

PART NUMBER	FIGURE	ITEM
11-1-3697-1	7	25
11-1-3699-1	4	5
11-1-3699-1	5	5
11-1-3700-0	4	9
11-1-3700-1	5	9
11-1-4010-1	7	10
11-1-4011-1	7	9
11-1-4235-1	1	15
929174160	1	14
92917A140	1	17
A-A-50294	BULK	14
A-A-52080	BULK	10
A-A-55126	BULK	5
A-A-55126	BULK	6
A-A-55126	BULK	7
HSS358-6	4	7
HSS358-6	5	7
MIL-C-43734	BULK	1
MIL-PRF-5038	BULK	9
MIL-T-5038	BULK	11
MIL-T-5608	BULK	12
MIL-W-5664	BULK	19
MS17830-06C	7	3
MS21083-CO6	7	11
MS27980-1B	6	3
MS27980-1B	7	8
MS27980-6B	6	2
MS27980-6B	7	7
MS27980-7B	6	1
MS27980-7B	7	5
MS27980-8B	6	4
MS27980-8B	7	6
MS51957-27	7	2
MS70113-1	7	22
NASM16491	2	1
PIA-C-44378	BULK	2
PIA-C-7219	BULK	3
PIA-T-5038	BULK	13
PIA-T-5038	6	5
PIA-W-4088	BULK	20
PS70104	7	12
PS70104	7	19
T-C-2754	BULK	4
V-T-295	BULK	15
V-T-295	BULK	16
V-T-295	BULK	17
V-T-295	BULK	18

END OF WORK PACKAGE



---

**MC-4 RAM AIR FREE-FALL PERSONNEL PARACHUTE SYSTEM  
EXPENDABLE/DURABLE SUPPLIES AND MATERIALS LIST**

---

**SCOPE**

This appendix lists expendable supplies and materials you will need to operate and maintain the 35-Foot Diameter Parachute. These items are authorized to you by CTA 50-970, Expendable Items (Except Medical, Class V, Repair Parts, and Heraldic Items).

**EXPLANATION OF COLUMNS**

**Column 1, Item Number.** This number is assigned to the entry in the listing and is referenced in the narrative instructions to identify the material (e.g., Use Cloth, Abrasive (Item 6, WP 0055 00)).

**Column 2, Level.** This column identifies the lowest level of maintenance that requires the listed item. (Enter as applicable).

- C - Operator or Crew
- O - Unit Maintenance
- F - Direct Support Maintenance
- H - General Support Maintenance
- D - Depot Maintenance

**Column 3, National Stock Number (NSN).** This is the National stock number assigned to the item; use it to request or requisition the item.

**Column 4, Description.** Indicates the Federal item name and, if required, a description to identify the item.

**Column 5, Unit of Measure (U/M).** Indicates the measure used in performing the actual maintenance function. This measure is expressed by a two-character alphabetical abbreviation (e.g., ea., in., pr.). If the unit of measure differs from the unit of issue, requisition the lowest unit of issue that will satisfy your requirements.

■ **Table 1. Expendable/Durable Supplies and Materials List**

(1) ITEM NUMBER	(2) LEVEL	(3) NATIONAL STOCK NUMBER	(4) DESCRIPTION	(5) UNIT OF MEASURE
1	0	7510-00-174-3205	Aid, Marking Red, Thick	BX
2	0	7510-00-282-3375	Aid, Marking Red, Thin	BX
3	0	6810-00-753-4993	Alcohol, Isopropyl (Anhydrous)	BT
4	0	1670-01-323-9900	Band, Rubber Retainer	BX
5	0	9160-00-253-1171	Beeswax, Technical, 1-LB Cake	LB
6	0	5350-00-221-0872	Cloth, Abrasive	YD
7	0	8305-01-506-0532	Cloth, Duck, Textured Nylon, Class 3, CG 483	YD
8	0	7920-00-044-9281	Cloth, Lint Free, Cleaning	BX
9	0	8305-01-315-7955	Cloth, Nylon Ripstop, Type I	YD
10	0	8305-01-315-7955	Cloth, Nylon, Type III, Class 3, Black	YD
11	0	8310-00-261-9741	Cord, Cotton, Size 24/4	TU
12	0	1670-01-359-9485	Cord, Dacron, 600-Pound, Type I	YD
13	0	4020-00-246-0688	Cord, Nylon, Type III	YD
14	0	7930-00-281-4731	Dishwashing Compound	SA

■ Table 1. Expendable/Durable Supplies and Materials List -- Continued

(1) ITEM NUMBER	(2) LEVEL	(3) NATIONAL STOCK NUMBER	(4) DESCRIPTION	(5) UNIT OF MEASURE
15	0	8315-00-106-5973	Fastener Tape, Hook, 1-IN. Wide, Type II, Class 1	YD
16	0	8315-00-106-5974	Fastener Tape, Pile, 1-IN. Wide, Type II, Class 1	YD
17	0	8315-00-151-6482	Fastener Tape, Pile, 2-IN. Wide, Type II, Class 1	YD
18	0	5325-00-359-6844	Fastener, Snap, Button	EA
19	0	5325-01-023-3843	Fastener, Snap, Eyelet	EA
20	0	5325-00-285-6250	Fastener, Snap, Socket	EA
21	0	5325-00-842-1879	Fastener, Snap, Stud	EA
22	0	5325-01-506-7568	Grommet, Rolled Rim and Spur Washer, No. 5, Type III, Class 2	EA
23	0	5325-01-506-9046	Grommet, Rolled Rim/Spur Washer, 305 Stainless Steel, No. 0	EA
24	0	5325-01-506-9030	Grommet, Rolled Rim/Spur Washer, 305 Stainless Steel, No. 2	EA
25	0	7510-00-634-6583	Ink, Marking, Parachute, Orange Yellow	BT
26	0	7510-00-286-5362	Ink, Marking, Parachute, Strata Blue	BT
27	0	9150-00-168-2000	Lubricant, Solid Film	CN
28	0	7520-00-973-1059	Marker, Felt Tip, Permanent, Black	BX
29	0	7520-01-060-5820	Pen, Ball Point	BX
30	0	7920-00-205-3570	Rag, Wiping	BE
31	0	9310-00-160-7858	Stencil Board, Oiled	SH
32	0	Commercial	Style Force 9, 1.9-OZ Ripstop Weave, 2-IN. Wide	
33	0	4020-00-753-6555	Tape, Lacing and Tying	YD
34	0	8315-01-506-4404	Tape, Nylon, 1-IN. Wide, Gray	YD
35	0	8315-01-506-8812	Tape, Nylon, 2-IN. Wide, Natural	YD
36	0	8315-00-255-7673	Tape, Nylon, Type III, ½-IN.	YD
37	0	8315-00-176-8082	Tape, Nylon, Type III, Class 1, ¾- IN. Wide	YD



■ Table 1. Expendable/Durable Supplies and Materials List -- Continued

(1) ITEM NUMBER	(2) LEVEL	(3) NATIONAL STOCK NUMBER	(4) DESCRIPTION	(5) UNIT OF MEASURE
38	0	7510-00-550-7125	Tape, Pressure Sensitive, Yellow, ½-IN. Wide	YD
39	0	8315-01-506-5694	Tape, Textile and Webbing, <sup>3</sup> / <sub>8</sub> -IN. Wide, Gray, 26270	YD
40	0	8310-00-261-9741	Thread, Cotton, 24/4	TU
41	0	8310-00-262-2780	Thread, Nylon, OD, Size 6, Natural Finish	TU
42	0	8310-00-277-1244	Thread, Nylon, OD, Size FF	TU
43	0	8310-00-262-2772	Thread, Nylon, Size E, Green	TU
44	0	8310-00-262-2770	Thread, Nylon, Size E, Natural	TU
45	0	8310-00-262-3324	Thread, Nylon, Size A	TU
46	0	9160-00-285-2044	Wax, Paraffin	LB
47	0	8305-00-270-1894	Webbing, Elastic, 1-IN. Wide	YD
48	0	8305-00-263-3592	Webbing, Nylon, Type II	YD
49	0	Local Purchase	Webbing, Textile, Nylon, Type VII, OD (Waistband), Class 2	YD
50	0	7930-001-506-9885	Cleaner, Industrial, Multipurpose Cleaning Fluid, (1010) (Everblum Gold™)	

END OF WORK PACKAGE



---

**MC-4 RAM AIR FREE-FALL PERSONNEL PARACHUTE SYSTEM  
ILLUSTRATED LIST OF MANUFACTURED ITEMS**

---

**MC-4 CONTINUITY SUSPENSION DEVICE**

Assemble the MC-4 Continuity Suspension Device in accordance with the illustrations below. Use the MC-4 Continuity Suspension Device as an aid in conducting the continuity check and other purpose in which the MC-4 requires suspension.

1. The MC-4 Continuity Suspension Device is constructed from a suitable piece of metal or plastic tubing, wood, or other light-weight material (approximately 16-feet in length).
2. Bolt or weld approximately 8 clamps (evenly spaced) to the Suspension Device.
3. Ensure both the clamps and the Suspension Device are capable of supporting the weight of an MC-4 main or reserve parachute.

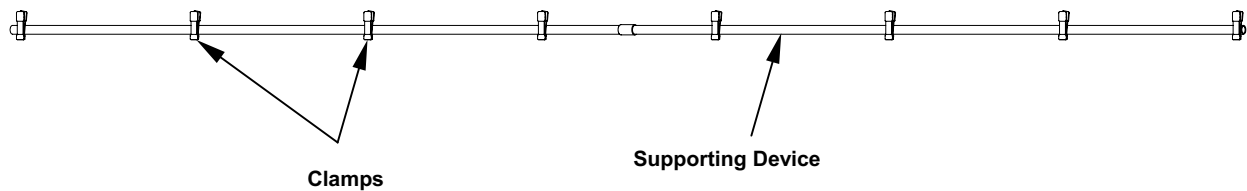

4. Once constructed, hang from a convenient point, normally from the ceiling, high enough to ensure the entire canopy is off the ground.
5. Attach an MC-4 main or reserve parachute to insure stability.

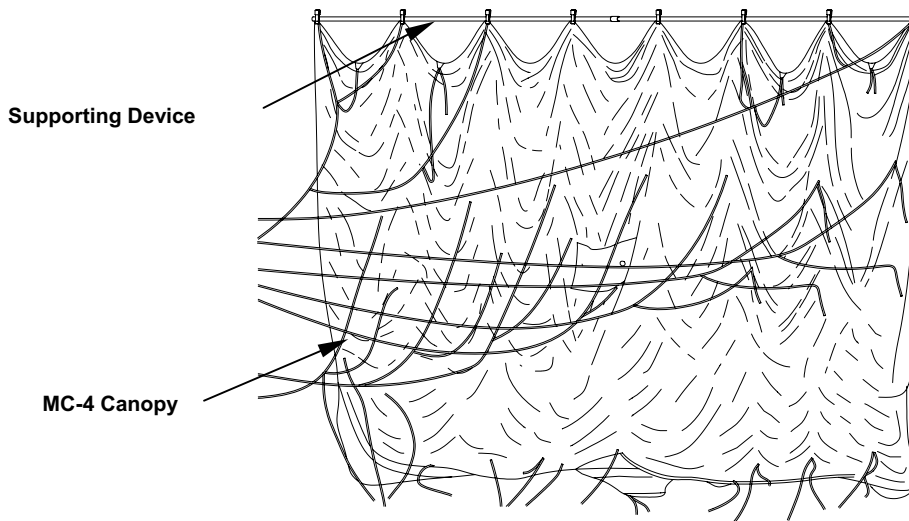

## SPLICING AID FABRICATION

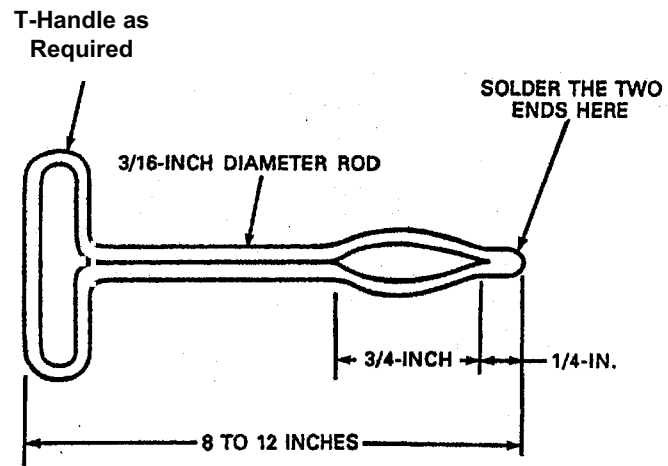

END OF WORK PACKAGE

## ALPHABETICAL INDEX

**Subject** **WP Sequence No. – Page No.**

### A

AAD Junction Plate .....	0045 00-1
Accordion Folding .....	0061 00-1
Acronyms and Abbreviations .....	0001 00-3
Activation Device, Installing .....	0014 00-43
After-Use Receipt .....	0004 00-8
Air Force Technical Order Forms .....	0062 00-3
Air Force Technical Orders .....	0062 00-2
Airing (and Shakeout) (Unit).....	0009 00-1
Application of Markings .....	0005 00-9/0006 00-12
AR2 Power Cable Assembly Installation/Mounting.....	0047 00-1
AR2 Ripcord Release Pocket.....	0046 00-1
Army Regulations .....	0062 00-2
Assembly – Reserve Parachute.....	0005 00-1
Attaching Loop, Suspension Line .....	0036 00-1
Attaching Loop, Suspension Line .....	0056 00-1
Attaching Risers to Harness.....	0014 00-2
Attachment Control Lines to Control Toggles .....	0005 00-10
Attachment of Canopy to Risers .....	0005 00-6/0006 00-9
Attachment of Pilot Chute, Bridle Line, and Deployment Bag .....	0006 00-13
Attachment of Risers to Harness/Container.....	0005 00-1
Attachment of the AR2 .....	0013 00-36

### B

Basting (DS).....	0050 00-1
Basting (Unit) .....	0015 00-2
Bulk Materials.....	0072 00-1

### C

Canopy Repair, General (Main and Reserve).....	0024 00-1
Canopy Replacement, Main.....	0025 00-1
Canopy Replacement, Reserve .....	0026 00-1
Canopy Rib .....	0058 00-1
Canopy Trim Check .....	0006 00-14
Canopy, Release Ripcord and Housing.....	0042 00-1
Cascade Lines (Alternate Method) .....	0055 00-1
Cleaning and Drying (Unit).....	0010 00-1
Cleaning Fabric Items With Hand Dishwashing Compound .....	0010 00-1
Closing Container.....	0013 00-24/0014 00-31
Common Name .....	0001 00-3
Common Tools and Equipment .....	0001 00-5
Configuration/Condition .....	0004 00-2
Connector Links, Main and Reserve Canopy .....	0032 00-1
Container/Harness .....	0037 00-1

**Subject**

**WP Sequence No. – Page No.**

**C - continued**

Control Lines .....	0057 00-1
Converting Reserve Canopy to Main Canopy.....	0049 00-1
Corrosion Prevention And Control (CPC) .....	0001 00-1
Crossport Main or Reserve Canopy.....	0027 00-1

**D**

Darning (DS) .....	0050 00-3
Darning (Unit).....	0015 00-4
Deployment Bag.....	0018 00-1
Deployment Bag, Main .....	0021 00-1
Deployment Capability .....	0002 00-1
Description Of Major Components .....	0002 00-1
Destruction Of Army Materiel To Prevent Enemy Use .....	0001 00-2
Drop Testing Criteria .....	0007 00-1
Drying Fabric Items .....	0010 00-3/0012 00-2

**E**

Equipment Characteristics, Capabilities And Features.....	0002 00-1
Equipment Data .....	0002 00-14
Equipment Description and Data .....	0002 00-1
Equipment Disposition .....	0011 00-8
Equipment Improvements and Recommendations, Reporting (EIR).....	0001 00-1
Equipment Name .....	0001 00-3

**F**

Fasteners, Snap .....	0039 00-1
Field Manuals .....	0062 00-2
Flaking Canopy .....	0013 00-6/0014 00-13
Folding Canopy .....	0013 00-7/0014 00-15
Forms .....	0062 00-2
Fresh-Water Contamination Test.....	0012 00-1

**G**

General Canopy Repair (Main and Reserve).....	0024 00-1
General Procedures for Air Delivery Equipment.....	0004 00-1
General Repair Procedures (DS).....	0050 00-1
General Repair Procedures (Unit) .....	0015 00-1
General Storage Requirements .....	0060 00-1
Grommets.....	0038 00-1

**Subject** **WP Sequence No. – Page No.**

**H**

Harness/Container .....0037 00-1  
 Hook and Pile Tapes, Riser .....0035 00-1  
 Housing, Main Ripcord .....0044 00-1  
 Housing, Reserve Ripcord .....0043 00-1  
 How to Use this Manual ..... v

**I**

Illustrated List of Manufactured Items .....0077 00-1  
 Initial Receipt.....0004 00-1  
 Inspection Criteria, Porosity .....0048 00-1  
 Inspection .....0011 00-1  
 Installation of Safety Stow .....0005 00-9  
 Installing Attaching Tie .....0004 00-2  
 Installing the Automatic Activation Device .....0014 00-43  
 In-Storage Inspection ..... 0011 00-8/ 0060 00-2  
 Introduction To Maintenance Allocation Chart (MAC) .....0063 00-1

**J**

Junction Plate, AAD .....0045 00-1

**L**

Layout and Line Check .....0013 00-3/0014 00-6  
 Layout.....0005 00-3/0006 00-3  
 Line Sets (Preferred Method), Suspension .....0054 00-1  
 Lines (4A/B and 5A/B), Suspension.....0053 00-1  
 Lines (Alternate Method), Suspension/Cascade .....0055 00-1  
 Lines, Control .....0057 00-1  
 List of Acronyms and Abbreviations.....0001 00-3  
 List of Effective Pages .....A  
 Location And Description of Major Components.....0002 00-1  
 Lubrication Service Intervals .....0008 00-3

**M**

Main and Reserve Parachute Characteristics, Table 1 .....0002 00-14  
 Main and Reserve Pilot Chute Attachment.....0020 00-1  
 Main Canopy Release Cable Channel.....0034 00-1  
 Main Canopy Release Ripcord and Housing .....0042 00-1  
 Main Canopy Replacement.....0025 00-1  
 Main Deployment Bag.....0021 00-1  
 Main or Reserve Canopy, Crossport.....0027 00-1  
 Main Parachute, Packing Procedures.....0014 00-1  
 Main Pilot Chute Bridle Line or Deployment Bag.....0018 00-1

**Subject**

**WP Sequence No. – Page No.**

**M - continued**

Main Pilot Chute .....	0019 00-1
Main Ripcord Housing .....	0043 00-1
Main Ripcord Pocket .....	0040 00-1
Main Risers .....	0033 00-1
Maintenance Allocation Chart (MAC), Introduction .....	0063 00-1
Maintenance Allocation Chart (MAC), Table 1 .....	0063 00-4
Maintenance Forms, Records and Reports .....	0001 00-1
Maintenance Functions .....	0063 00-1
Maintenance Functions/Procedures .....	0007 00-1
Marine Corps Forms .....	0062 00-3
Marking and Restencilling (DS) .....	0052 00-1
Marking and Restencilling (Unit) .....	0017 00-1
Marking Parachutes .....	0004 00-2
Modification Work Order (MWO) Compliance Record Page .....	0004 00-6

**N**

National Stock Number Index .....	0074 00-1
Nomenclature Cross-Reference List .....	0001 00-3

**O**

Official Name .....	0001 00-3
Ozone Depleting Substances (ODS) .....	0001 00-1

**P**

Packing Procedures – Main Parachute .....	0014 00-1
Packing Procedures – Reserve Parachute .....	0013 00-1
Pack-In-Process Inspection .....	0011 00-1/0014 00-2
Parachute Log Record .....	0004 00-2
Parachute Repack Interval .....	0007 00-1
Part Number Index .....	0075 00-1
Patching Crossports .....	0027 00-1
Pilot Chute Attachment, Main and Reserve .....	0020 00-1
Pilot Chute, Main .....	0019 00-1
Porosity Inspection Criteria .....	0048 00-1
Porosity Procedures .....	0048 00-1
Power Cable Assembly Installation/Mounting, AR2 .....	0047 00-1
Preparation for Shipment .....	0001 00-3/0061 00-1
Preparation for Storage .....	0001 00-3/0060 00-1
Preventive Maintenance Checks And Services (PMCS) .....	0008 00-1
Preventive Maintenance Checks And Services (PMCS), Introduction .....	0007 00-1
Publication Indexes .....	0062 00-1



**Subject** **WP Sequence No. – Page No.**

**R**

3-Ring Release/Riser Inspection .....	0011 00-3
Receipt of Used Parachute .....	0004 00-8
References .....	0062 00-1
References, Air Force Technical Order Forms .....	0062 00-3
References, Air Force Technical Orders .....	0062 00-2
References, Army Regulations .....	0062 00-2
References, DA PAM .....	0062 00-1
References, Field Manuals .....	0062 00-1
References, Forms .....	0062 00-2
References, Joint Regulations .....	0062 00-2
References, Marine Corps Forms .....	0062 00-3
References, Publication Indexes .....	0062 00-1
References, Technical Bulletins .....	0062 00-2
References, Technical Manuals .....	0062 00-1
Repair Parts and Special Tools List (RPSTL), Introduction .....	0064 00-1
Repair Procedures, General (DS) .....	0050 00-1
Repair Procedures, General (Unit) .....	0015 00-1
Replacements, Section .....	0059 00-1
Replacing a Filled Out or Unserviceable Log Record .....	0004 00-7
Replacing a Lost Log Record .....	0004 00-8
Replacing Crossport .....	0027 00-3
Reporting Equipment Improvement Recommendations (EIRs) .....	0001 00-1
Reporting Errors and Recommending Improvements .....	i
Reserve Canopy Replacement .....	0026 00-1
Reserve Canopy, Crossport .....	0027 00-1
Reserve Parachute Characteristics, Table 1 .....	0002 00-14
Reserve Parachute, Assembly .....	0005 00-1
Reserve Parachute, Packing Procedures .....	0013 00-1
Reserve Pilot Chute Attachment .....	0020 00-1
Reserve Pilot Chute or Reserve Deployment Bag and Bridle Line .....	0022 00-1
Reserve Ripcord Housing .....	0043 00-1
Reserve Ripcord Pocket .....	0041 00-1
Restenciling (DS) .....	0052 00-1
Restenciling (Unit) .....	0017 00-1
Restitching (DS) .....	0050 00-2
Restitching (Unit) .....	0015 00-2
Rib, Canopy .....	0058 00-1
Rigger Rolling .....	0061 00-1
Rinsing Parachute Assembly Immersed in Fresh-Water .....	0010 00-2/0012 00-2
Rinsing Parachute Assembly Immersed in Salt-Water .....	0010 00-2/0012 00-1
Ripcord Grip Test .....	0006 00-1
Ripcord Housing, Main .....	0044 00-1
Ripcord Housing, Reserve .....	0037 00-1
Ripcord Pocket, Main .....	0040 00-1
Ripcord Pocket, Reserve .....	0041 00-1
Ripcord Release Pocket, AR2 .....	0046 00-1
Ripcord Test .....	0005 00-1
Riser Hook and Pile Tapes .....	0035 00-1
Risers, Main .....	0033 00-1
Routine Inspection .....	0011 00-1

**Subject**

**WP Sequence No. – Page No.**

**S**

Safety Stow Loop .....	0023 00-1
Safety, Care and Handling .....	0001 00-5/0002 00-14
Salt-Water Contamination Test .....	0012 00-1
Scope on Manual .....	0001 00-1
Searing and Waxing (DS) .....	0051 00-1
Searing and Waxing (Unit) .....	0016 00-1
Searing Crossports .....	0027 00-2
Section Replacements .....	0059 00-1
Service Upon Receipt .....	0004 00-1
Setting Deployment Breaks.....	0014 00-8
Sewing Machine Code Symbols, Table 1 (DS).....	0050 00-2
Sewing Machine Code Symbols, Table 1 (Unit) .....	0015 00-2
Sewing Procedures (DS).....	0050 00-1
Sewing Procedures (Unit) .....	0015 00-1
Shakeout and Airing (Unit).....	0009 00-1
Shipment .....	0061 00-1
Shipment, Preparation for .....	0061 00-1
Slack Checker Inspection.....	0011 00-6
Slider Stop, Main and Reserve Canopy .....	0031 00-1
Slider, Main and Reserve Canopy .....	0030 00-1
Snap Fasteners .....	0039 00-1
Spanwise Line Check.....	0006 00-23
Special Tools List .....	0073 00-1
Special Tools, TMDE and Support Equipment .....	0001 00-5
Stabilizer Left or Right, Main or Reserve Canopy.....	0028 00-1
Stitching (DS).....	0050 00-2
Stitching (Unit).....	0015 00-2
Stitching and Restitching Specifications, Table 2 (DS).....	0050 00-2
Stitching and Restitching Specifications, Table 2 (Unit) .....	0015 00-2
Storage Criteria .....	0060 00-1
Storage Requirements, General .....	0060 00-1
Storage Specifics for Parachutes.....	0060 00-1
Storage, Preparation for .....	0060 00-1
Stow Canopy and Suspension Lines .....	0013 00-21
Stowing Canopy in Deployment Bag .....	0014 00-28
Stowing Suspension Lines.....	0014 00-29
Stroke Simulator Test.....	0013 00-34/0014 00-37
Suspension Line Attaching Loop .....	0036 00-1
Suspension Line Attaching Loop .....	0056 00-1
Suspension Line Sets (Preferred Method).....	0054 00-1
Suspension Lines (4A/B and 5A/B).....	0053 00-1
Suspension Lines/Cascade Lines (Alternate Method).....	0055 00-1

**T**

Table of Contents .....	ii
Tail Seam, Main or Reserve Canopy .....	0029 00-1
Technical Bulletins .....	0062 00-2
Technical Manuals .....	0062 00-1
Technical/Rigger-Type Inspection .....	0011 00-1

**Subject**

**WP Sequence No. – Page No.**

**T**

Temporary Tacking (DS).....	0050 00-1
Temporary Tacking (Unit) .....	0015 00-1
Theory of Operation .....	0003 00-1

**W**

Warning Summary .....	a
Warranty Information.....	0001 00-3
Waxing (DS).....	0051 00-1
Waxing (Unit) .....	0016 00-1



By Order of the Secretaries of the Army, Air Force, and Navy (Including the Marine Corps):

Official:



JOEL B. HUDSON

*Administrative Assistant to the  
Secretary of the Army*

0318803

JOHN M. KEANE  
*General, United States Army  
Acting Chief of Staff*

**MICHAEL E. RYAN**  
*GENERAL, USAF  
Chief of Staff*

Official:

**GEORGE T. BABBETT**

*General, USAF*

*Commander, Air Force Materiel Command*

**D.G. MORRAL**  
*Rear Admiral, USN  
Program Executive Officer  
For Expeditionary Warfare  
Naval Sea Systems Command*

**R.P. SHOCKEY**

*Director, Program Support*

*Marine Corps Systems Command*

DISTRIBUTION:

To be distributed in accordance with Initial Distribution Number (IDN 255304), requirements for TM 10-1670-287-23&P.



## ***These are the instructions for sending an electronic 2028***

The following format must be used if submitting an electronic 2028. The subject line must be exactly the same and all fields must be included; however only the following fields are mandatory: 1, 3, 4, 5, 6, 7, 8, 9, 10, 13, 15, 16, 17, and 27.

From: "Whomever" <whomever@avma27.army.mil>

To: amssbriml@natick.army.mil

Subject: DA Form 2028

1. **From:** Joe Smith
2. **Unit:** home
3. **Address:** 4300 Park
4. **City:** Hometown
5. **St:** MO
6. **Zip:** 77777
7. **Date Sent:** 19-OCT-93
8. **Pub no:** 55-2840-229-23
9. **Pub Title:** TM
10. **Publication Date:** 04-JUL-85
11. **Change Number:** 7
12. **Submitter Rank:** MSG
13. **Submitter FName:** Joe
14. **Submitter MName:** T
15. **Submitter LName:** Smith
16. **Submitter Phone:** 123-123-1234
17. **Problem:** 1
18. **Page:** 2
19. **Paragraph:** 3
20. **Line:** 4
21. **NSN:** 5
22. **Reference:** 6
23. **Figure:** 7
24. **Table:** 8
25. **Item:** 9
26. **Total:** 123
27. **Text:**

This is the text for the problem below line 27.





<b>RECOMMENDED CHANGES TO PUBLICATIONS AND BLANK FORMS</b> For use of this form, see AR 25-30; the proponent agency is ODISC4.						Use Part II (reverse) for Repair Parts and Special Tool Lists (RPSTL) and Supply Catalogs/Supply Manuals (SC/SM).	<b>DATE</b> <i>21 October 2003</i>
<b>TO:</b> (Forward to proponent of publication or form) (Include ZIP Code) COMMANDER U.S. ARMY TANK-AUTOMOTIVE AND ARMAMENT COMMAND ATTN: AMSTA-LC-CECT 15 KANSAS STREET NATICK, MA 01760-5052						<b>FROM:</b> (Activity and location) (Include ZIP Code)  <i>PFC Jane Doe</i> <i>CO A 3<sup>rd</sup> Engineer BR</i> <i>Ft. Leonardwood, MO 63108</i>	
<b>PART I – ALL PUBLICATIONS (EXCEPT RPSTL AND SC/SM) AND BLANK FORMS</b>							
<b>PUBLICATION/FORM NUMBER</b>  TM 10-1670-296-23&P				<b>DATE</b>  30 October 2002	<b>TITLE</b>  Unit Manual for Ancillary Equipment for Low Velocity Air Drop Systems		
<b>ITEM NO.</b>	<b>PAGE NO.</b>	<b>PARA-GRAPH</b>	<b>LINE NO. *</b>	<b>FIGURE NO.</b>	<b>TABLE NO.</b>	<b>RECOMMENDED CHANGES AND REASON</b> <i>(Provide exact wording of recommended changes, if possible).</i>	
	0036 00-2				1	<i>In table 1, Sewing Machine Code Symbols, the second sewing machine code symbol should be MD ZZ not MD 22.</i>  <i>Change the manual to show Sewing Machine, Industrial: Zig-Zag; 308 stitch; medium-duty; NSN 3530-01-181-1421 as a MD ZZ code symbol.</i>	
<small>*Reference to line numbers within the paragraph or subparagraph.</small>							
<b>TYPED NAME, GRADE OR TITLE</b>  Jane Doe, PFC				<b>TELEPHONE EXCHANGE/AUTOVON, PLUS EXTENSION</b>  508-233-4141		<b>SIGNATURE</b>  Jane Doe <i>Jane Doe</i>	

<b>TO:</b> <i>(Forward direct to addressee listed in publication)</i> COMMANDER U.S. ARMY TANK-AUTOMOTIVE AND ARMAMENT COMMAND ATTN: AMSTA-LC-CECT 15 KANSAS STREET NATICK, MA 01760-5052	<b>FROM:</b> <i>(Activity and location) (Include ZIP Code)</i> <i>PFC Jane Doe</i> <i>CO A 3<sup>rd</sup> Engineer BR</i> <i>Ft. Leonardwood, MO 63108</i>	<b>DATE</b> 21 October 2003
--	---	--------------------------------

**PART II – REPAIR PARTS AND SPECIAL TOOL LISTS AND SUPPLY CATALOGS/SUPPLY MANUALS**

<b>PUBLICATION NUMBER</b> TM 10-1670-296-23&P	<b>DATE</b> 30 October 2002	<b>TITLE</b> Unit Manual for Ancillary Equipment for Low Velocity Air Drop Systems
--	--------------------------------	---

PAGE NO.	COLM NO.	LINE NO.	NATIONAL STOCK NUMBER	REFERENCE NO.	FIGURE NO.	ITEM NO.	TOTAL NO. OF MAJOR ITEMS SUPPORTED	RECOMMENDED ACTION
0066 00-1					4			<i>Callout 16 in figure 4 is pointed to a <u>D-Ring</u>. In the Repair Parts List key for figure 4, item 16 is called a <u>Snap Hook</u>. Please correct one or the other.</i>

SAMPLE

**PART III – REMARKS** *(Any general remarks or recommendations, or suggestions for improvement of publications and blank forms. Additional blank sheets may be used if more space is needed.)*

TYPED NAME, GRADE OR TITLE	TELEPHONE EXCHANGE/AUTOVON, PLUS EXTENSION	SIGNATURE
----------------------------	--	-----------

<p align="center"><b>RECOMMENDED CHANGES TO PUBLICATIONS AND BLANK FORMS</b></p> <p>For use of this form, see AR 25-30; the proponent agency is ODISC4.</p>						Use Part II (reverse) for Repair Parts and Special Tool Lists (RPSTL) and Supply Catalogs/Supply Manuals (SC/SM).	DATE
<b>TO:</b> (Forward to proponent of publication or form) (Include ZIP Code) COMMANDER U.S. ARMYTANK-AUTOMOTIVE AND ARMAMENT COMMAND ATTN: AMSTA-LC-CECT 15 KANSAS STREET NATICK, MA 01760-5052						<b>FROM:</b> (Activity and location) (Include ZIP Code)	
<b>PART I – ALL PUBLICATIONS (EXCEPT RPSTL AND SC/SM) AND BLANK FORMS</b>							
PUBLICATION/FORM NUMBER TM 10-1670-287-23&P				DATE 30 July 2003	TITLE MC-4 RAM AIR FREE FALL PERSONNEL PARACHUTE SYSTEM		
ITEM NO.	PAGE NO.	PARA-GRAPH	LINE NO. *	FIGURE NO.	TABLE NO.	RECOMMENDED CHANGES AND REASON <i>(Provide exact wording of recommended changes, if possible).</i>	
*Reference to line numbers within the paragraph or subparagraph.							
TYPED NAME, GRADE OR TITLE				TELEPHONE EXCHANGE/AUTOVON, PLUS EXTENSION		SIGNATURE	

<b>TO:</b> (Forward direct to addressee listed in publication) COMMANDER U.S. ARMYTANK-AUTOMOTIVE AND ARMAMENT COMMAND ATTN: AMSTA-LC-CECT 15 KANSAS STREET NATICK, MA 01760-5052	<b>FROM:</b> (Activity and location) (Include ZIP Code)	<b>DATE</b>
--	---	-------------

**PART II – REPAIR PARTS AND SPECIAL TOOL LISTS AND SUPPLY CATALOGS/SUPPLY MANUALS**

PUBLICATION NUMBER TM 10-1670-23&P	DATE 30 July 2003	TITLE MC-4 RAM AIR FREE FALL PERSONNEL PARACHUTE SYSTEM
---------------------------------------	----------------------	---

PAGE NO.	COLM NO.	LINE NO.	NATIONAL STOCK NUMBER	REFERENCE NO.	FIGURE NO.	ITEM NO.	TOTAL NO. OF MAJOR ITEMS SUPPORTED	RECOMMENDED ACTION

**PART III – REMARKS** (Any general remarks or recommendations, or suggestions for improvement of publications and blank forms. Additional blank sheets may be used if more space is needed.)

--

TYPED NAME, GRADE OR TITLE	TELEPHONE EXCHANGE/AUTOVON, PLUS EXTENSION	SIGNATURE
----------------------------	--	-----------

<p align="center"><b>RECOMMENDED CHANGES TO PUBLICATIONS AND BLANK FORMS</b></p> <p>For use of this form, see AR 25-30; the proponent agency is ODISC4.</p>						Use Part II (reverse) for Repair Parts and Special Tool Lists (RPSTL) and Supply Catalogs/Supply Manuals (SC/SM).	DATE
<b>TO:</b> (Forward to proponent of publication or form) (Include ZIP Code) COMMANDER U.S. ARMYTANK-AUTOMOTIVE AND ARMAMENT COMMAND ATTN: AMSTA-LC-CECT 15 KANSAS STREET NATICK, MA 01760-5052						<b>FROM:</b> (Activity and location) (Include ZIP Code)	
<b>PART I – ALL PUBLICATIONS (EXCEPT RPSTL AND SC/SM) AND BLANK FORMS</b>							
PUBLICATION/FORM NUMBER TM 10-1670-287-23&P						DATE 30 July 2003	TITLE MC-4 RAM AIR FREE FALL PERSONNEL PARACHUTE SYSTEM
ITEM NO.	PAGE NO.	PARA-GRAPH	LINE NO. *	FIGURE NO.	TABLE NO.	RECOMMENDED CHANGES AND REASON <i>(Provide exact wording of recommended changes, if possible).</i>	
<i>*Reference to line numbers within the paragraph or subparagraph.</i>							
TYPED NAME, GRADE OR TITLE				TELEPHONE EXCHANGE/AUTOVON, PLUS EXTENSION		SIGNATURE	

<b>TO:</b> (Forward direct to addressee listed in publication) COMMANDER U.S. ARMYTANK-AUTOMOTIVE AND ARMAMENT COMMAND ATTN: AMSTA-LC-CECT 15 KANSAS STREET NATICK, MA 01760-5052	<b>FROM:</b> (Activity and location) (Include ZIP Code)	<b>DATE</b>
--	---	-------------

**PART II – REPAIR PARTS AND SPECIAL TOOL LISTS AND SUPPLY CATALOGS/SUPPLY MANUALS**

PUBLICATION NUMBER TM 10-1670-23&P	DATE 30 July 2003	TITLE MC-4 RAM AIR FREE FALL PERSONNEL PARACHUTE SYSTEM
---------------------------------------	----------------------	---

PAGE NO.	COLM NO.	LINE NO.	NATIONAL STOCK NUMBER	REFERENCE NO.	FIGURE NO.	ITEM NO.	TOTAL NO. OF MAJOR ITEMS SUPPORTED	RECOMMENDED ACTION

**PART III – REMARKS** (Any general remarks or recommendations, or suggestions for improvement of publications and blank forms. Additional blank sheets may be used if more space is needed.)

TYPED NAME, GRADE OR TITLE	TELEPHONE EXCHANGE/AUTOVON, PLUS EXTENSION	SIGNATURE
----------------------------	--	-----------

## The Metric System and Equivalents

### *Linear Measure*

1 centimeter = 10 millimeters = .39 inch  
 1 decimeter = 10 centimeters = 3.94 inches  
 1 meter = 10 decimeters = 39.37 inches  
 1 dekameter = 10 meters = 32.8 feet  
 1 hectometer = 10 dekameters = 328.08 feet  
 1 kilometer = 10 hectometers = 3,280.8 feet

### *Weights*

1 centigram = 10 milligrams = .15 grain  
 1 decigram = 10 centigrams = 1.54 grains  
 1 gram = 10 decigrams = .035 ounce  
 1 dekagram = 10 grams = .35 ounce  
 1 hectogram = 10 dekagrams = 3.52 ounces  
 1 kilogram = 10 hectograms = 2.2 pounds  
 1 quintal = 100 kilograms = 220.46 pounds  
 1 metric ton = 10 quintals = 1.1 short tons

### *Liquid Measure*

1 centiliter = 10 milliliters = .34 fl. ounce  
 1 deciliter = 10 centiliters = 3.38 fl. ounces  
 1 liter = 10 deciliters = 33.81 fl. ounces  
 1 dekaliter = 10 liters = 2.64 gallons  
 1 hectoliter = 10 dekaliters = 26.42 gallons  
 1 kiloliter = 10 hectoliters = 264.18 gallons

### *Square Measure*

1 sq. centimeter = 100 sq. millimeters = .155 sq. inch  
 1 sq. decimeter = 100 sq. centimeters = 15.5 sq. inches  
 1 sq. meter (centare) = 100 sq. decimeters = 10.76 sq. feet  
 1 sq. dekameter (are) = 100 sq. meters = 1,076.4 sq. feet  
 1 sq. hectometer (hectare) = 100 sq. dekameters = 2.47 acres  
 1 sq. kilometer = 100 sq. hectometers = .386 sq. mile

### *Cubic Measure*

1 cu. centimeter = 1000 cu. millimeters = .06 cu. inch  
 1 cu. decimeter = 1000 cu. centimeters = 61.02 cu. inches  
 1 cu. meter = 1000 cu. decimeters = 35.31 feet

## Approximate Conversion Factors

<i>To change</i>	<i>To</i>	<i>Multiply by</i>	<i>To change</i>	<i>To</i>	<i>Multiply by</i>
inches	centimeters	2.540	ounce-inches	newton-meters	.007062
feet	meters	.305	centimeters	inches	.394
yards	meters	.914	meters	feet	3.280
miles	kilometers	1.609	meters	yards	1.094
square inches	square centimeters	6.451	kilometers	miles	.621
square feet	square meters	.093	square centimeters	square inches	.155
square yards	square meters	.836	square meters	square feet	10.764
square miles	square kilometers	2.590	square meters	square yards	1.196
acres	square hectometers	.405	square kilometers	square miles	.386
cubic feet	cubic meters	.028	square hectometers	acres	2.471
cubic yards	cubic meters	.765	cubic meters	cubic feet	35.315
fluid ounces	milliliters	29.573	cubic meters	cubic yards	1.308
pints	liters	.473	milliliters	fluid ounces	.034
quarts	liters	.946	liters	pints	2.113
gallons	liters	3.785	liters	quarts	1.057
ounces	grams	28.349	liters	gallons	.264
pounds	kilograms	.454	grams	ounces	.035
short tons	metric tons	.907	kilograms	pounds	2.205
pound-feet	newton-meters	1.356	metric tons	short tons	1.102
pound-inches	newton-meters	.11296			

## Temperature (Exact)

°F	Fahrenheit temperature	5/9 (after subtracting 32)	Celsius temperature	°C
----	---------------------------	-------------------------------	------------------------	----

**PIN: 069481-000**